

Installation manual

Daikin Altherma 3 M

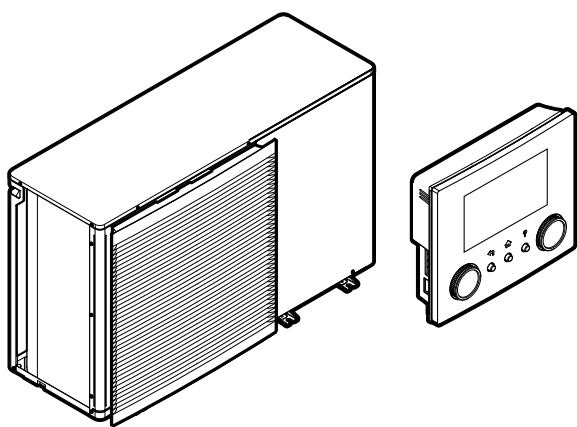

<https://daikintechnicaldatahub.eu>



EBLA09D▲V3▼
EBLA09D▲3V3▼

▲ = A, B, C, ..., Z

▼ = , , 1, 2, 3, ..., 9, A, B, C, ..., Z

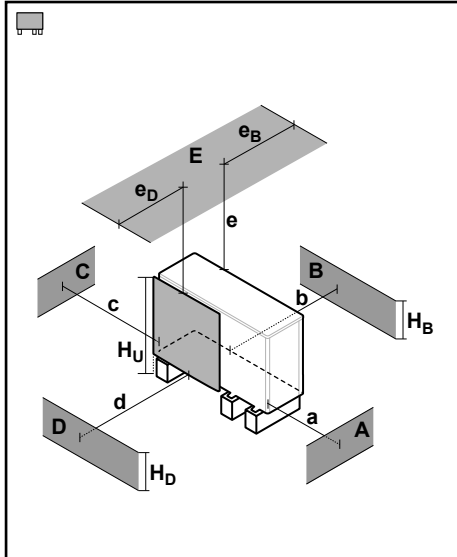
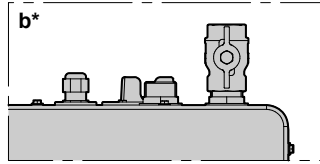
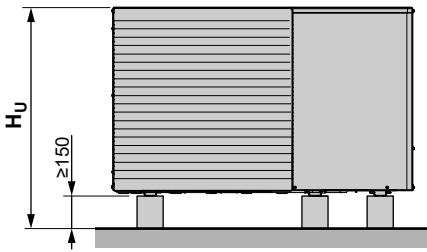

A-E	H _B H _D H _U	(mm)						
		a	b*	c	d	e	e _B	e _D
B	—		≥300					
A, B, C	—	≥500	≥300	≥100				
B, E	—		≥300			≥1000		≤500
A, B, C, E	—	≥500	≥300	≥150		≥1000		≤500
D	—				≥500			
D, E	—				≥500	≥1000		≤500
A, C	—	≥500		≥100				
B, D	(H _B OR H _D) ≤ H _U		≥300		≥500			
	(H _B AND H _D) > H _U	✗						
B, D, E	(H _B OR H _D) ≤ H _U		≥300		≥1000	≥1000		≤500
	H _B < H _D		≥300		≥1000	≥1000	≤500	
	(H _B AND H _D) > H _U	✗						
A, C, D, E	—	≥500		≥150	≥500	≥1000	≤500	
A, B, C, D, E	(H _B OR H _D) ≤ H _U	≥500	≥300	≥150	≥1000	≥1000		≤500
	H _B < H _D	≥500	≥300	≥150	≥1000	≥1000	≤500	
	(H _B AND H _D) > H _U	✗						

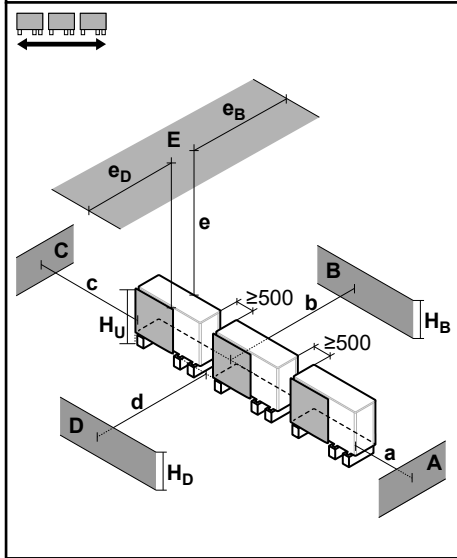

B	—		≥300					
A, B, C	—	≥500	≥300	≥500				
B, E	—		≥300			≥1000		≤500
A, B, C, E	—	≥500	≥300	≥500		≥1000		≤500
D	—				≥500			
D, E	—				≥1000	≥1000		≤500
A, C	—	≥500		≥500				
B, D	(H _B OR H _D) ≤ H _U		≥300		≥500			
	(H _B AND H _D) > H _U	✗						
B, D, E	(H _B OR H _D) ≤ H _U		≥300		≥1000	≥1000		≤500
	H _B < H _D		≥300		≥1000	≥1000	≤500	
	(H _B AND H _D) > H _U	✗						
A, C, D, E	—	≥500		≥500	≥1000	≥1000	≤500	
A, B, C, D, E	(H _B OR H _D) ≤ H _U	≥500	≥300	≥500	≥1000	≥1000		≤500
	H _B < H _D	≥500	≥300	≥500	≥1000	≥1000	≤500	
	(H _B AND H _D) > H _U	✗						

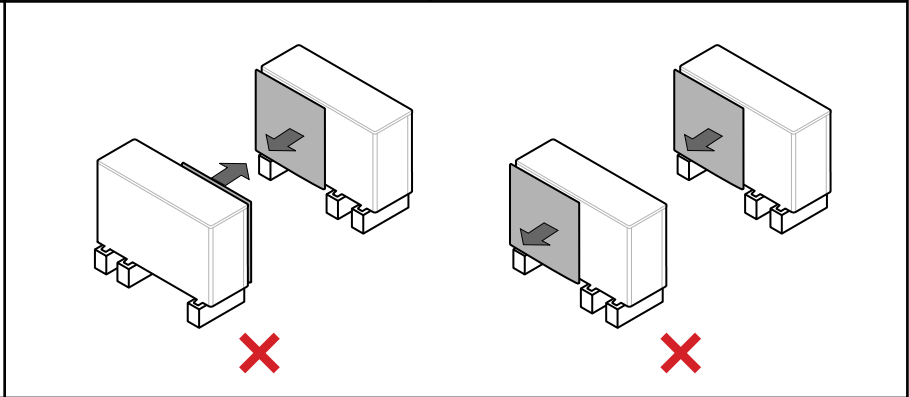
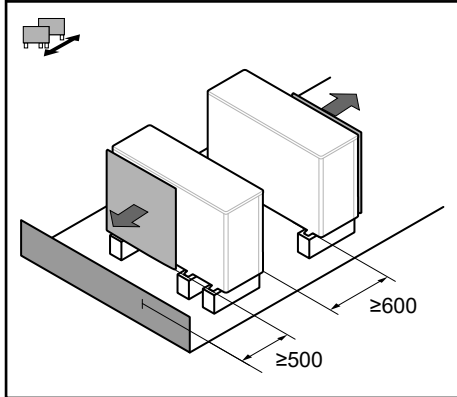

Table of contents

1	About this document	3	8.3.1	What is a weather-dependent curve?	32
2	Specific installer safety instructions	4	8.3.2	2-points curve	32
3	About the box	5	8.3.3	Slope-offset curve	32
3.1	Outdoor unit.....	5	8.3.4	Using weather-dependent curves	33
3.1.1	To remove the accessories from the outdoor unit.....	5	8.4	Settings menu.....	34
3.1.2	To remove the transportation stay	5	8.4.1	Main zone	34
4	Unit installation	6	8.4.2	Additional zone	34
4.1	Preparing the installation site	6	8.4.3	Information	34
4.1.1	Installation site requirements of the outdoor unit	6	8.5	Menu structure: Overview installer settings.....	35
4.2	Mounting the outdoor unit.....	6	9	Commissioning	36
4.2.1	To provide the installation structure	6	9.1	Checklist before commissioning	36
4.2.2	To install the outdoor unit.....	7	9.2	Checklist during commissioning	36
4.2.3	To provide drainage	7	9.2.1	To check the minimum flow rate	36
4.2.4	To install the discharge grille	8	9.2.2	To perform an air purge	37
4.3	Opening and closing the unit	8	9.2.3	To perform an operation test run	37
4.3.1	To open the outdoor unit.....	8	9.2.4	To perform an actuator test run	37
4.3.2	To close the outdoor unit	8	9.2.5	To perform an underfloor heating screed dryout.....	37
5	Piping installation	8	10	Hand-over to the user	38
5.1	Preparing water piping.....	8	11	Technical data	39
5.1.1	To check the water volume and flow rate	9	11.1	Piping diagram: Outdoor unit.....	39
5.1.2	Third-party tank requirements.....	9	11.2	Wiring diagram: Outdoor unit.....	41
5.2	Connecting water piping	10	1	About this document	
5.2.1	To connect the water piping.....	10	Target audience		
5.2.2	To fill the water circuit	10	Authorised installers		
5.2.3	To protect the water circuit against freezing	10	Documentation set		
5.2.4	To fill the domestic hot water tank	11	This document is part of a documentation set. The complete set consists of:		
5.2.5	To insulate the water piping	11	<ul style="list-style-type: none"> ▪ General safety precautions: <ul style="list-style-type: none"> ▪ Safety instructions that you must read before installing ▪ Format: Paper (in the box of the outdoor unit) ▪ Operation manual: <ul style="list-style-type: none"> ▪ Quick guide for basic usage ▪ Format: Paper (in the box of the outdoor unit) ▪ User reference guide: <ul style="list-style-type: none"> ▪ Detailed step-by-step instructions and background information for basic and advanced usage ▪ Format: Digital files on https://www.daikin.eu. Use the search function 🔍 to find your model. ▪ Installation manual: <ul style="list-style-type: none"> ▪ Installation instructions ▪ Format: Paper (in the box of the outdoor unit) ▪ Installer reference guide: <ul style="list-style-type: none"> ▪ Preparation of the installation, good practices, reference data, ... ▪ Format: Digital files on https://www.daikin.eu. Use the search function 🔍 to find your model. ▪ Addendum book for optional equipment: <ul style="list-style-type: none"> ▪ Additional info about how to install optional equipment ▪ Format: Paper (in the box of the outdoor unit) + Digital files on https://www.daikin.eu. Use the search function 🔍 to find your model. 		
6	Electrical installation	12	The latest revision of the supplied documentation is published on the regional Daikin website and is available via your dealer.		
6.1	About electrical compliance.....	12	The original instructions are written in English. All other languages are translations of the original instructions.		
6.2	Guidelines when connecting the electrical wiring	12			
6.3	Connections to the outdoor unit.....	12			
6.3.1	To connect the electrical wiring to the outdoor unit.....	14			
6.3.2	To connect the main power supply	14			
6.3.3	To connect the backup heater power supply	16			
6.3.4	External backup heater kit	17			
6.3.5	To connect the user interface	19			
6.3.6	To connect the shut-off valve.....	21			
6.3.7	To connect the electricity meters	21			
6.3.8	To connect the domestic hot water pump	22			
6.3.9	To connect the alarm output	22			
6.3.10	To connect the space cooling/heating ON/OFF output	22			
6.3.11	To connect the changeover to external heat source...	23			
6.3.12	To connect the power consumption digital inputs	23			
6.3.13	To connect the safety thermostat (normally closed contact)	24			
6.3.14	To connect a Smart Grid.....	24			
7	Finishing the outdoor unit installation	26			
7.1	To check the insulation resistance of the compressor.....	26			
8	Configuration	26			
8.1	Overview: Configuration	26			
8.1.1	To access the most used commands	26			
8.2	Configuration wizard.....	27			
8.2.1	Configuration wizard: Language	27			
8.2.2	Configuration wizard: Time and date	27			
8.2.3	Configuration wizard: System	27			
8.2.4	Configuration wizard: Backup heater	29			
8.2.5	Configuration wizard: Main zone.....	30			
8.2.6	Configuration wizard: Additional zone.....	30			
8.2.7	Configuration wizard: Tank	31			
8.3	Weather-dependent curve.....	32			

2 Specific installer safety instructions

Technical engineering data

- A **subset** of the latest technical data is available on the regional Daikin website (publicly accessible).
- The **full set** of the latest technical data is available on the Daikin Business Portal (authentication required).

Online tools

In addition to the documentation set, some online tools are available for installers:

- **Daikin Technical Data Hub**
 - Central hub for technical specifications of the unit, useful tools, digital resources, and more.
 - Publicly accessible via <https://daikintechdatahub.eu>.
- **Heating Solutions Navigator**
 - Digital toolbox that offers a variety of tools to facilitate the installation and configuration of heating systems.
 - To access the Heating Solutions Navigator, registration to the Stand By Me platform is required. For more information, see <https://professional.standbyme.daikin.eu>.
- **Daikin e-Care**
 - Mobile app for installers and service technicians that allows you to register, configure and troubleshoot heating systems.
 - Use the QR codes below to download the mobile app for iOS and Android devices. Registration to the Stand By Me platform is required to access the app.

App Store

Google Play



2 Specific installer safety instructions

Always observe the following safety instructions and regulations.

Installation site (see "[4.1 Preparing the installation site](#)" [p 6])



WARNING

Follow the service space dimensions in this manual to install the unit correctly. See "[4.1.1 Installation site requirements of the outdoor unit](#)" [p 6].

Special requirements for R32 (see "[4.1.1 Installation site requirements of the outdoor unit](#)" [p 6])



WARNING

- Do NOT pierce or burn refrigerant cycle parts.
- Do NOT use means to accelerate the defrosting process or to clean the equipment, other than those recommended by the manufacturer.
- Be aware that R32 refrigerant does NOT contain an odour.



WARNING

The appliance shall be stored so as to prevent mechanical damage and in a well-ventilated room without continuously operating ignition sources (example: open flames, an operating gas appliance or an operating electric heater).



WARNING

Make sure installation, servicing, maintenance and repair comply with instructions from Daikin and with applicable legislation (for example national gas regulation) and are executed **ONLY** by authorised persons.

Mounting the outdoor unit (see "[4.2 Mounting the outdoor unit](#)" [p 6])



WARNING

Fixing method of the outdoor unit **MUST** be in accordance with the instructions from this manual. See "[4.2 Mounting the outdoor unit](#)" [p 6].

Opening and closing the unit (see "[4.3 Opening and closing the unit](#)" [p 8])



DANGER: RISK OF ELECTROCUTION



DANGER: RISK OF BURNING/SCALDING

Piping installation (see "[5 Piping installation](#)" [p 8])



WARNING

Field piping **MUST** be in accordance with the instructions from this manual. See "[5 Piping installation](#)" [p 8].

In case of freeze protection by glycol:



WARNING

Ethylene glycol is toxic.



WARNING

Due to the presence of glycol, the system can corrode. Uninhibited glycol becomes acidic under the influence of oxygen. High temperatures and the presence of copper accelerate this process. The acidic uninhibited glycol attacks metal surfaces and forms galvanic corrosion cells that cause severe damage to the system. It is therefore important to respect the following:

- A qualified water specialist has treated the water.
- Select glycol with corrosion inhibitors to prevent glycol oxidation and subsequent acid formation.
- Do NOT use automotive glycol because these contain corrosion inhibitors with only a limited lifetime. On top of that, they also contain silicates that can foul or plug the system.
- Do NOT use galvanised pipes in glycol systems because they provoke certain components in the glycol's corrosion inhibitor to precipitate.

Electrical installation (see "[6 Electrical installation](#)" [p 12])



DANGER: RISK OF ELECTROCUTION



WARNING

Electrical wiring **MUST** be in accordance with the instructions from:

- This manual. See "[6 Electrical installation](#)" [p 12].
- The wiring diagram, which is delivered with the unit, located at the inside of the service cover. For a translation of its legend, see "[11.2 Wiring diagram: Outdoor unit](#)" [p 41].



WARNING

ALWAYS use multicore cable for power supply cables.

WARNING
Rotating fan. Before powering ON the outdoor unit, make sure that the discharge grille covers the fan as protection against a rotating fan. See "4.2.4 To install the discharge grille" [▶ 8].

WARNING
 ALWAYS use multicore cable for power supply cables.

CAUTION
 Do NOT push or place redundant cable length into the unit.

WARNING
 The backup heater MUST have a dedicated power supply and MUST be protected by the safety devices required by the applicable legislation.

CAUTION
 To guarantee the unit is completely earthed, ALWAYS connect the backup heater power supply and the earth cable.

WARNING
Stripped wire. Make sure that stripped wire cannot make contact with possible water on the bottom plate.

Commissioning (see "9 Commissioning" [▶ 36])

WARNING
 Commissioning MUST be in accordance with the instructions from this manual. See "9 Commissioning" [▶ 36].

3 About the box

Keep the following in mind:

- At delivery, the unit MUST be checked for damage and completeness. Any damage or missing parts MUST be reported immediately to the claims agent of the carrier.
- Bring the packed unit as close as possible to its final installation position to prevent damage during transport.
- Prepare in advance the path along which you want to bring the unit to its final installation position.

3.1 Outdoor unit

3.1.1 To remove the accessories from the outdoor unit

NOTICE
Unpacking – Top packaging. When you remove the top packaging, hold the box containing the discharge grille to prevent it from falling.

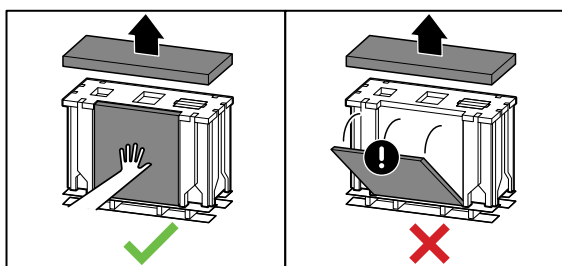

1 Remove the accessories on top and in front of the unit.

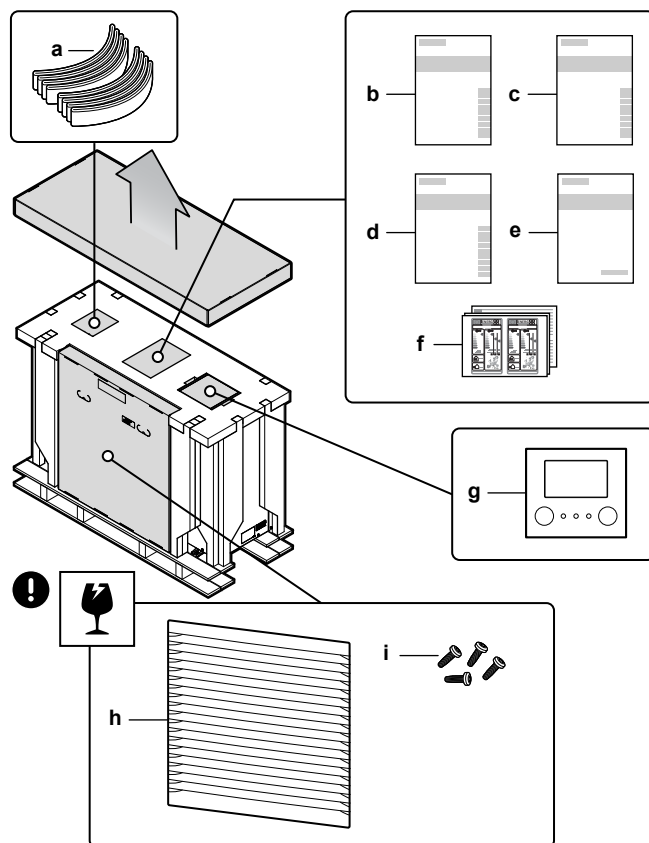

- a Slings to carry the unit
- b General safety precautions
- c Operation manual
- d Installation manual
- e Addendum book for optional equipment
- f Energy label
- g User interface (front plate, rear plate, screws, and wall plugs)
- h Discharge grille
- i Screws for discharge grille

2 After opening the unit (see "4.3.1 To open the outdoor unit" [▶ 8]), remove the accessory inside the unit.

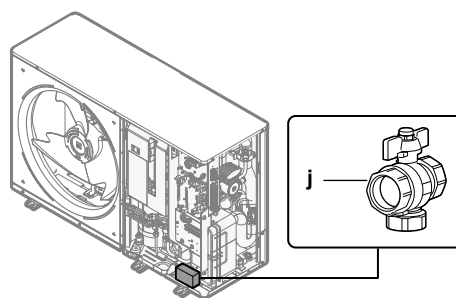

j Shut-off valve (with integrated filter)

3.1.2 To remove the transportation stay

NOTICE
 If the unit is operated with the transportation stay attached, abnormal vibration or noise may be generated.

The transportation stay protects the unit during transport. During installation it must be removed.

Prerequisite: Open the service cover. See "4.3.1 To open the outdoor unit" [▶ 8].

4 Unit installation

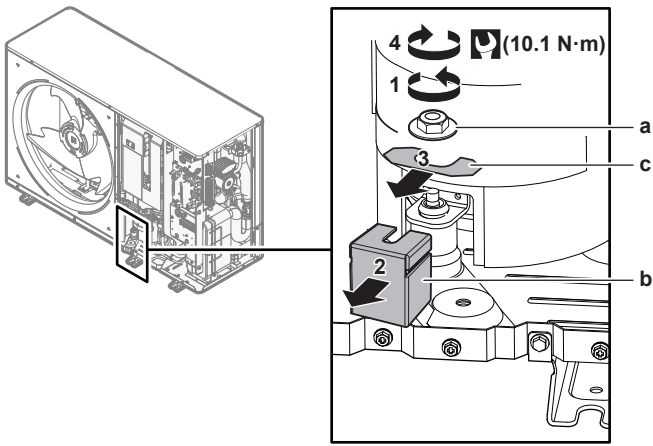

- a Nut
- b Transportation stay
- c Spacer

- 1 Remove the nut (a) of the compressor mounting bolt.
- 2 Remove and discard the transportation stay (b).
- 3 Remove and discard the spacer (c).
- 4 Reinstall the nut (a) of the compressor mounting bolt and torque to 10.1 N·m.

4 Unit installation

4.1 Preparing the installation site



WARNING

The appliance shall be stored so as to prevent mechanical damage and in a well-ventilated room without continuously operating ignition sources (example: open flames, an operating gas appliance or an operating electric heater).

4.1.1 Installation site requirements of the outdoor unit

Mind the spacing guidelines. See figure 1 on the inside of the front cover.

The symbols can be interpreted as follows:

- A, C Right side and left side obstacles (walls/baffle plates)
- B Suction side obstacle (wall/baffle plate)
- D Discharge side obstacle (wall/baffle plate)
- E Top side obstacle (roof)

a,b,c,d,e Minimum service space between the unit and obstacles

A, B, C, D and E

e_B Maximum distance between the unit and the edge of obstacle E, in the direction of obstacle B

e_D Maximum distance between the unit and the edge of obstacle E, in the direction of obstacle D

H_U Height of the unit including the installation structure

H_B, H_D Height of obstacles B and D

✗ NOT allowed

The outdoor unit is designed for outdoor installation only, and for the following ambient temperatures:

Cooling mode	10~43°C
Heating mode	<ul style="list-style-type: none"> ▪ For models with integrated backup heater or if the external backup heater kit is installed: -25~35°C ▪ Otherwise: -25~25°C
DHW production	-25~35°C

Mind the measurement guidelines:

Maximum height difference between domestic hot water tank and outdoor unit	5 m
Maximum distance between outdoor unit and...	
domestic hot water tank	10 m
3-way valve	10 m
external backup heater kit	10 m

Special requirements for R32

The outdoor unit contains an internal refrigerant circuit (R32), but you do NOT have to do any refrigerant field piping, or refrigerant charging.

Mind the following requirements and precautions:



WARNING

- Do NOT pierce or burn refrigerant cycle parts.
- Do NOT use means to accelerate the defrosting process or to clean the equipment, other than those recommended by the manufacturer.
- Be aware that R32 refrigerant does NOT contain an odour.



WARNING

The appliance shall be stored so as to prevent mechanical damage and in a well-ventilated room without continuously operating ignition sources (example: open flames, an operating gas appliance or an operating electric heater).



WARNING

Make sure installation, servicing, maintenance and repair comply with instructions from Daikin and with applicable legislation (for example national gas regulation) and are executed ONLY by authorised persons.

4.2 Mounting the outdoor unit

4.2.1 To provide the installation structure

Use 6 sets of M12 anchor bolts, nuts and washers. Provide at least 150 mm of free space below the unit. Additionally, make sure the unit is positioned at least 100 mm above the maximum expected level of snow.

Note: If you install freeze protection valves, make sure to also respect the space requirements of the freeze protection valves.

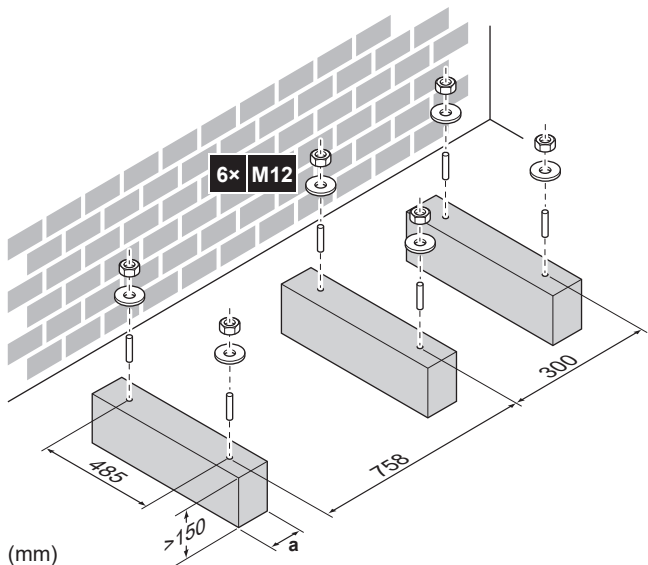

- a Make sure not to cover the drain holes. See "Drain holes (dimensions in mm)" [p 7].

i INFORMATION

The recommended height of the upper protruding part of the bolts is 20 mm.

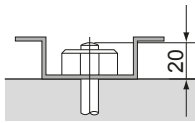

! NOTICE

Fix the outdoor unit to the foundation bolts using nuts with resin washers (a). If the coating on the fastening area is stripped off, the metal can rust easily.



4.2.2 To install the outdoor unit

- 1 Put the slings (delivered as accessories) through the unit's feet (left and right).
- 2 Carry the unit by the slings, and put it onto the installation structure.

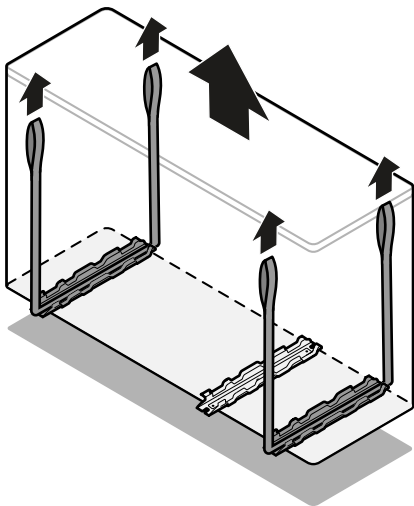

- 3 Remove the slings, and dispose of them.
- 4 Fix the unit to the installation structure.

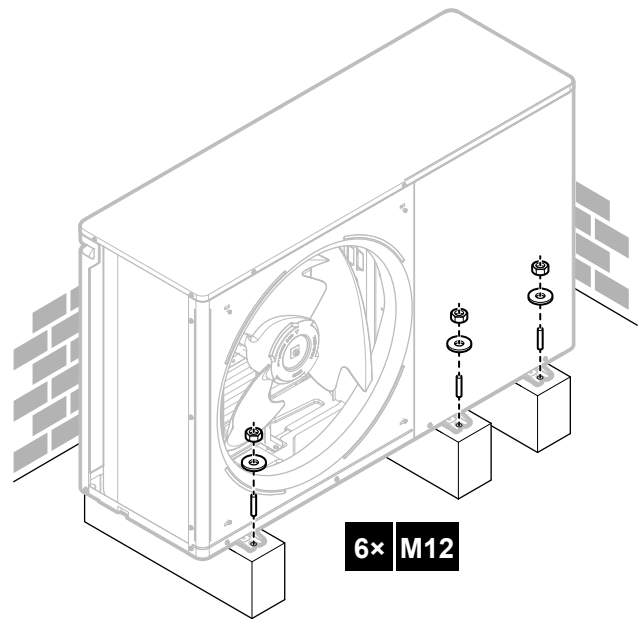

4.2.3 To provide drainage

Make sure that condensation water can be evacuated properly.

i INFORMATION

If necessary, you can use a drain pan (field supply) to prevent drain water from dripping.

! NOTICE

If the unit CANNOT be installed fully level, always make sure that the inclination is towards the backside of the unit. This is required to guarantee proper drainage.

! NOTICE

If drain holes of the outdoor unit are covered by a mounting base or by floor surface, raise the unit to provide a free space of more than 150 mm under the outdoor unit.

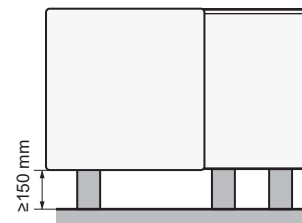

Drain holes (dimensions in mm)

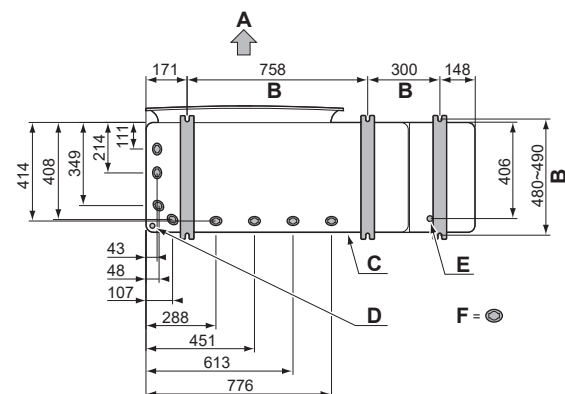

- A Discharge side
- B Distance between anchor points
- C Bottom frame
- D Knockout hole for snow
- E Drain hole for safety valve

5 Piping installation

F Drain holes

Snow

In regions with snowfall, snow might build up and freeze between the heat exchanger and the casing of the unit. This might decrease the operating efficiency. To prevent this:

- 1 Remove the knockout hole (a) by tapping on the attachment points with a flat head screwdriver and a hammer.

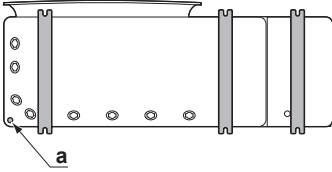

- 2 Remove the burrs, and paint the edges and areas around the edges using repair paint to prevent rusting.

NOTICE

When making knockout holes, do NOT damage the casing and underlying piping.

4.2.4 To install the discharge grille

- 1 Insert the hooks. To prevent breaking the hooks:
 - First insert the bottom hooks (2×).
 - Then insert the top hooks (2×).
- 2 Insert and fix the screws (4×)(delivered as accessory).

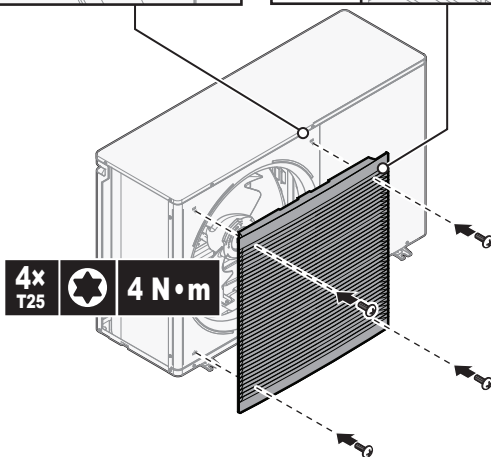
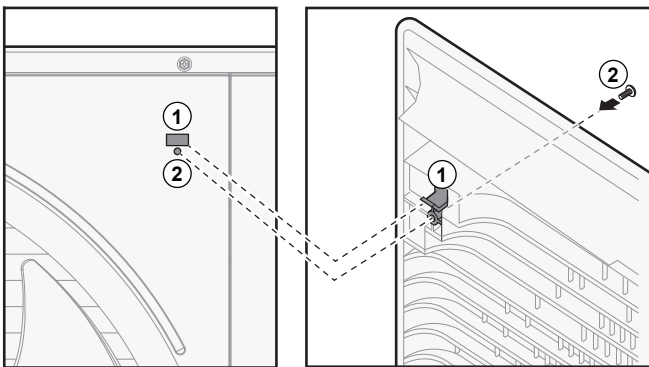

4.3 Opening and closing the unit

4.3.1 To open the outdoor unit

DANGER: RISK OF ELECTROCUTION

DANGER: RISK OF BURNING/SCALDING

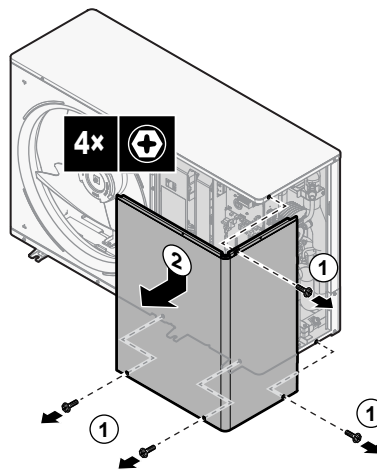

4.3.2 To close the outdoor unit

NOTICE

Speed nut. Make sure the speed nut for the top screw is correctly attached to the service cover.

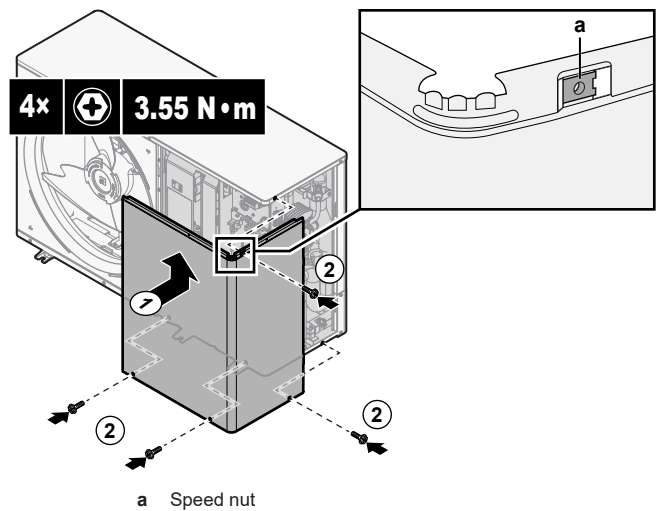

5 Piping installation

5.1 Preparing water piping

NOTICE

In case of plastic pipes, make sure they are fully oxygen diffusion tight according to DIN 4726. The diffusion of oxygen into the piping can lead to excessive corrosion.

NOTICE

Water circuit requirements. Make sure to comply with the water pressure and water temperature requirements below. For additional water circuit requirements, see the installer reference guide.

- **Water pressure.** The maximum water pressure is 4 bar. Provide adequate safeguards in the water circuit to ensure that the maximum pressure is NOT exceeded.
- **Water temperature.** All installed piping and piping accessories (valve, connections,...) MUST withstand the following temperatures:

INFORMATION

The following figure is an example and may NOT completely match your system layout

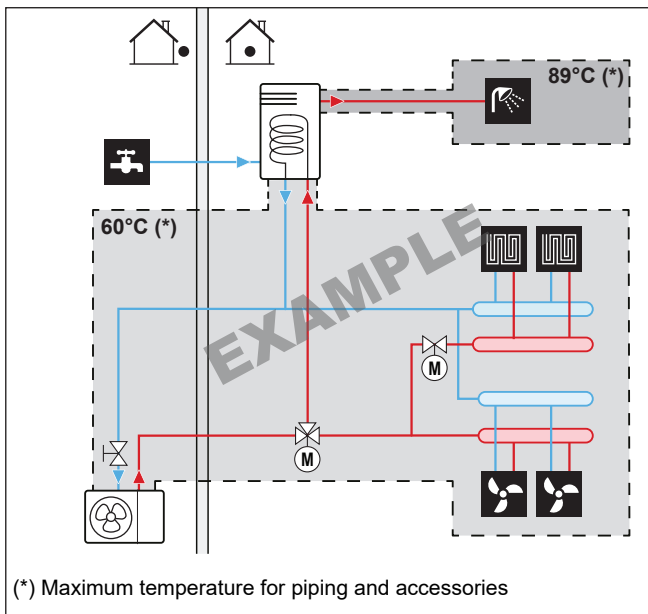

5.1.1 To check the water volume and flow rate

Minimum water volume

Check that the total water volume in the installation is higher than the minimum water volume, the internal water volume of the outdoor unit NOT included:

If...	Then the minimum water volume is...
Cooling operation	20 l
Heating/defrost operation and...	
Preheating on the tank is possible. This is possible in the following cases: <ul style="list-style-type: none"> EKHWP* tank + booster heater EKHWS*D* tank + booster heater + DHW pump 	0 l
Preheating on the tank is not possible, but a backup heater (internal or external) is present.	20 l
Preheating on the tank is not possible, and there is no backup heater.	50 l

NOTICE

When circulation in each space heating/cooling loop is controlled by remotely controlled valves, it is important that the minimum water volume is guaranteed, even if all of the valves are closed.

Maximum water volume

NOTICE

The maximum water volume depends on whether glycol is added to the water circuit. For more information on the addition of glycol, refer to "5.2.3 To protect the water circuit against freezing" [p 10].

Use the following graph to determine the maximum water volume for the calculated pre-pressure.

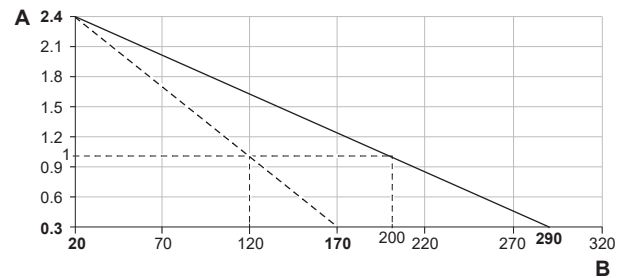

A Pre-pressure (bar)
 B Maximum water volume (l)
 — Water
 - - - Water + glycol

Minimum flow rate

Check that the minimum flow rate (required during defrost/backup heater operation (if applicable)) in the installation is guaranteed in all conditions.

If operation is...	Then the minimum required flow rate is...
Cooling	20 l/min
Heating/defrost when outdoor temperature is above -5°C	
Heating/defrost when outdoor temperature is below -5°C	22 l/min
Domestic hot water production	28 l/min

NOTICE

If glycol was added to the water circuit, and the temperature of the water circuit is low, the flow rate will NOT be displayed on the user interface. In this case, the minimum flow rate can be checked by way of the pump test.

NOTICE

When circulation in each or certain space heating loops is controlled by remotely controlled valves, it is important that the minimum flow rate is guaranteed, even if all valves are closed. In case the minimum flow rate cannot be reached, a flow error 7H will be generated (no heating or operation).

See the installer reference guide for more information.

See the recommended procedure as described in "9.2 Checklist during commissioning" [p 36].

5.1.2 Third-party tank requirements

In case of a third-party tank, the tank shall adhere to the following requirements:

- The heat exchanger coil of the tank is $\geq 1.05 \text{ m}^2$ and $\leq 3.7 \text{ m}^2$.
- The tank thermistor must be located above the heat exchanger coil.
- The booster heater must be located above the heat exchanger coil.

NOTICE

Performance. Performance data for third-party tanks CANNOT be provided, and performance CANNOT be guaranteed.

5 Piping installation

5.2 Connecting water piping

5.2.1 To connect the water piping

! NOTICE

Do NOT use excessive force when connecting the field piping and make sure the piping is aligned properly. Deformed pipes can cause the unit to malfunction.

! NOTICE

When connecting the field piping, hold the nut on the inside of the unit in place using a spanner to provide extra leverage.

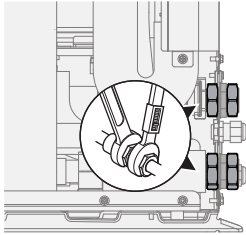

- 1 Connect the shut-off valve (with integrated filter) to the outdoor unit water inlet, using thread sealant.

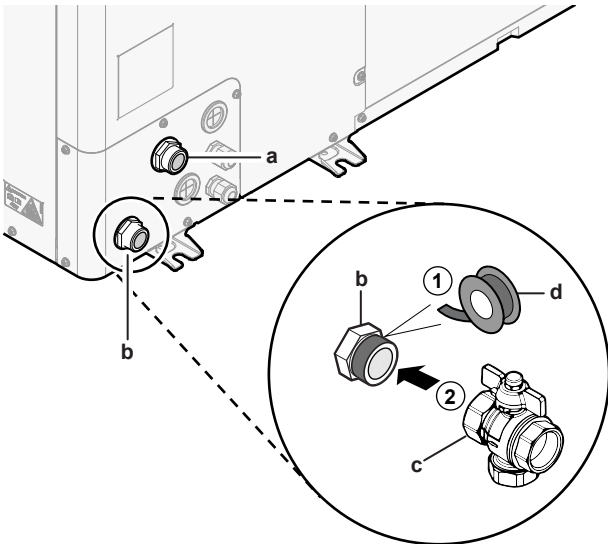

- a Water OUT (screw connection, male, 1")
- b Water IN (screw connection, male, 1")
- c Shut-off valve with integrated filter (delivered as accessory)(2× screw connection, female, 1")
- d Thread sealant

- 2 Connect the field piping to the shut-off valve.
- 3 Connect the field piping to the outdoor unit water outlet.

! NOTICE

About the shut-off valve with integrated filter (delivered as accessory):

- The installation of the valve at the water inlet is mandatory.
- Mind the flow direction of the valve.

! NOTICE

For service purposes, it is recommended to also install a shut-off valve and drain point to the water OUT connection. This shut-off valve and drain point are field supplied.

! NOTICE

Install air purge valves at all local high points.

! NOTICE

In case an optional domestic hot water tank is installed: A pressure relief valve (field supply) with an opening pressure of maximum 10 bar (= 1 MPa) must be installed on the domestic cold water inlet connection in accordance with the applicable legislation.

5.2.2 To fill the water circuit

To fill the water circuit, use a field supply filling kit. Make sure you comply with the applicable legislation.

! NOTICE

For models with integrated backup heater: The unit contains an automatic air purge valve on the backup heater. Make sure it is open. All automatic air purge valves in the system (in the unit, and in the field piping –if any) must remain open after commissioning.



For other models: The unit contains a manual air purge valve. Make sure it is closed. Only open it when performing an air purge.



5.2.3 To protect the water circuit against freezing

About freeze protection

Frost can damage the system. To prevent the hydraulic components from freezing, the software is equipped with special frost protection functions such as water pipe freeze prevention and drain prevention (see the installer reference guide) that include the activation of a pump in case of low temperatures.

However, in case of a power failure, these functions cannot guarantee protection.

Do one of the following to protect the water circuit against freezing:

- Add glycol to the water. Glycol lowers the freezing point of the water.
- Install freeze protection valves. Freeze protection valves drain the water from the system before it can freeze. Insulate the freeze protection valves in a similar way as the water piping, but do NOT insulate the inlet and outlet (release) of these valves.

! WARNING

Ethylene glycol is toxic. If you add glycol to the water, do NOT install freeze protection valves. The valves release the toxic glycol when they are activated. **Possible consequence:**

- Heart, kidney or liver damage in case of glycol swallowing or skin contact with glycol.
- Nausea, sickness and diarrhea in case of glycol inhalation.

! NOTICE

If you add glycol to the water, you also need to install a flow switch (EKFLSW1).

Freeze protection by glycol

About freeze protection by glycol

Adding glycol to the water lowers the freezing point of water.



WARNING

Ethylene glycol is toxic.



WARNING

Due to the presence of glycol, the system can corrode. Uninhibited glycol becomes acidic under the influence of oxygen. High temperatures and the presence of copper accelerate this process. The acidic uninhibited glycol attacks metal surfaces and forms galvanic corrosion cells that cause severe damage to the system. It is therefore important to respect the following:

- A qualified water specialist has treated the water.
- Select glycol with corrosion inhibitors to prevent glycol oxidation and subsequent acid formation.
- Do NOT use automotive glycol because these contain corrosion inhibitors with only a limited lifetime. On top of that, they also contain silicates that can foul or plug the system.
- Do NOT use galvanised pipes in glycol systems because they provoke certain components in the glycol's corrosion inhibitor to precipitate.



NOTICE

Glycol absorbs water from its environment. Therefore do NOT add glycol that has been exposed to air. Leaving the cap off the glycol container causes the concentration of water to increase. The glycol concentration is then lower than assumed. As a result, the hydraulic components might freeze up after all. Take preventive actions to ensure a minimal exposure of the glycol to air.

Types of glycol

The types of glycol that can be used depend on whether the system contains a domestic hot water tank:

If...	Then...
The system contains a domestic hot water tank	Only use propylene glycol ^(a)
The system does NOT contain a domestic hot water tank	You can use either propylene glycol ^(a) or ethylene glycol

^(a) Propylene glycol, including the necessary inhibitors, classified as Category III according to EN1717.

Required concentration of glycol

The required concentration of glycol depends on the lowest expected outdoor temperature, and on whether you want to protect the system from bursting or from freezing. To prevent the system from freezing, more glycol is required.

Add glycol according to the table below.

Lowest expected outdoor temperature	Prevent from bursting	Prevent from freezing
-5°C	10%	15%
-10°C	15%	25%
-15°C	20%	35%
-20°C	25%	—
-25°C	30%	—
-30°C	35%	—



INFORMATION

- Protection against bursting: the glycol will prevent the piping from bursting, but NOT the liquid inside the piping from freezing.
- Protection against freezing: the glycol will prevent the liquid inside the piping from freezing.



NOTICE

- The required concentration might differ depending on the type of glycol. ALWAYS compare the requirements from the table above with the specifications provided by the glycol manufacturer. If necessary, meet the requirements set by the glycol manufacturer.
- The added concentration of glycol should NEVER exceed 35%.
- If the liquid in the system is frozen, the pump will NOT be able to start. Mind that if you only prevent the system from bursting, the liquid inside might still freeze.
- When water is at standstill inside the system, the system is very likely to freeze and get damaged.

Glycol and the maximum allowed water volume

Adding glycol to the water circuit reduces the maximum allowed water volume of the system. For more information, see the installer reference guide (topic "To check the water volume and flow rate").

Glycol setting



NOTICE

If glycol is present in the system, setting [E-0D] must be set to 1. If the glycol setting is NOT set correctly, the liquid inside the piping can freeze.

Freeze protection by freeze protection valves

About freeze protection valves

When no glycol is added to the water, you can use freeze protection valves to drain the water from the system before it can freeze.

- Install freeze protection valves (field supply) at all lowest points of the field piping.
- Normally closed valves (located indoors near the piping entry/exit points) can prevent that all water from indoor piping is drained when the freeze protection valves open.



NOTICE

When freeze protection valves are installed, set the minimum cooling setpoint (default=7°C) at least 2°C higher than the maximum opening temperature of the freeze protection valve. If lower, freeze protection valves can open during cooling operation.

For more information, see the installer reference guide.

5.2.4 To fill the domestic hot water tank

See the installation manual of the domestic hot water tank.

5.2.5 To insulate the water piping

The piping in the complete water circuit MUST be insulated to prevent condensation during cooling operation and reduction of the heating and cooling capacity.

Outdoor water piping insulation



NOTICE

Outside piping. Make sure the outside piping is insulated as instructed to protect against hazards.

For piping in free air, it is recommended to use the insulation thickness as shown in below table as a minimum (with $\lambda=0.039$ W/mK).

6 Electrical installation

Piping length (m)	Minimum insulation thickness (mm)
<20	19
20~30	32
30~40	40
40~50	50

For other cases the minimum insulation thickness can be determined using the Hydronic Piping Calculation tool.

The Hydronic Piping Calculation tool is part of the Heating Solutions Navigator which can be reached via <https://professional.standby.me.daikin.eu>.

Please contact your dealer if you have no access to Heating Solutions Navigator.

This recommendation ensures good operation of the unit, however, local regulations may differ and shall be followed.

6 Electrical installation



DANGER: RISK OF ELECTROCUTION



WARNING

Rotating fan. Before powering ON the outdoor unit, make sure that the discharge grille covers the fan as protection against a rotating fan. See "4.2.4 To install the discharge grille" [p 8].



WARNING

ALWAYS use multicore cable for power supply cables.



CAUTION

Do NOT push or place redundant cable length into the unit.



NOTICE

The distance between the high voltage and low voltage cables should be at least 50 mm.

6.1 About electrical compliance

Equipment complying with EN/IEC 61000-3-12 (European/International Technical Standard setting the limits for harmonic currents produced by equipment connected to public low-voltage systems with input current >16 A and ≤75 A per phase.).



6.2 Guidelines when connecting the electrical wiring













Tightening torques

Item	Tightening torque (N•m)
X1M	2.45 ±10%
X2M	0.88 ±10%
X3M	0.88 ±10%
X4M	2.45 ±10%
X5M	0.88 ±10%
X9M	2.45 ±10%
X10M	0.88 ±10%

6.3 Connections to the outdoor unit

Item	Description
Power supply (main)	See "6.3.2 To connect the main power supply" [p 14].
Power supply (backup heater) (in case of outdoor unit with integrated backup heater)	See "6.3.3 To connect the backup heater power supply" [p 16].
Backup heater kit + Bypass valve kit (in case of external backup heater kit)	See "6.3.4 External backup heater kit" [p 17].
User interface	See "6.3.5 To connect the user interface" [p 19].
Shut-off valve	See "6.3.6 To connect the shut-off valve" [p 21].
Electricity meters	See "6.3.7 To connect the electricity meters" [p 21].
Domestic hot water pump	See "6.3.8 To connect the domestic hot water pump" [p 22].
Alarm output	See "6.3.9 To connect the alarm output" [p 22].
Space cooling/heating operation control	See "6.3.10 To connect the space cooling/heating ON/OFF output" [p 22].
Changeover to external heat source control	See "6.3.11 To connect the changeover to external heat source" [p 23].
Power consumption digital inputs	See "6.3.12 To connect the power consumption digital inputs" [p 23].
Safety thermostat	See "6.3.13 To connect the safety thermostat (normally closed contact)" [p 24].
Smart Grid	See "6.3.14 To connect a Smart Grid" [p 24].

Item	Description
Room thermostat (wired or wireless)	 In case of wireless room thermostat, see: <ul style="list-style-type: none"> Installation manual of the wireless room thermostat Addendum book for optional equipment In case of wired room thermostat without multi-zoning base unit, see: <ul style="list-style-type: none"> Installation manual of the wired room thermostat Addendum book for optional equipment In case of wired room thermostat with multi-zoning base unit, see: <ul style="list-style-type: none"> Installation manual of the wired room thermostat (digital or analogue) + multi-zoning base unit Addendum book for optional equipment In this case: <ul style="list-style-type: none"> You need to connect the wired room thermostat (digital or analogue) to the multi-zoning base unit You need to connect the multi-zoning base unit to the outdoor unit For cooling/heating operation, you also need to implement a relay (field supply, see addendum book for optional equipment)
	 Wires: 0.75 mm ² Maximum running current: 100 mA
	 For the main zone: <ul style="list-style-type: none"> [2.9] Control [2.A] Ext thermostat type For the additional zone: <ul style="list-style-type: none"> [3.A] Ext thermostat type [3.9] (read-only) Control

Item	Description
Heat pump convector	 There are different controllers and setups possible for the heat pump convectors. Depending on the setup, you also need to implement a relay (field supply, see addendum book for optional equipment). For more information, see: <ul style="list-style-type: none"> Installation manual of the heat pump convectors Installation manual of the heat pump convector options Addendum book for optional equipment
	 Wires: 0.75 mm ² Maximum running current: 100 mA
	 For the main zone: <ul style="list-style-type: none"> [2.9] Control [2.A] Ext thermostat type For the additional zone: <ul style="list-style-type: none"> [3.A] Ext thermostat type [3.9] (read-only) Control
Remote outdoor sensor	 See: <ul style="list-style-type: none"> Installation manual of the remote outdoor sensor Addendum book for optional equipment
	 Wires: 2×0.75 mm ²
	 [9.B.1]=1 (External sensor = Outdoor) [9.B.2] Ext. amb. sensor offset [9.B.3] Averaging time
Remote indoor sensor	 See: <ul style="list-style-type: none"> Installation manual of the remote indoor sensor Addendum book for optional equipment
	 Wires: 2×0.75 mm ²
	 [9.B.1]=2 (External sensor = Room) [1.7] Room sensor offset
Human Comfort Interface	 See: <ul style="list-style-type: none"> Installation and operation manual of the Human Comfort Interface Addendum book for optional equipment
	 Wires: 2×(0.75~1.25 mm ²) Maximum length: 500 m
	 [2.9] Control [1.6] Room sensor offset

6 Electrical installation

Item	Description
(in case of DHW tank) 3-way valve	<p>See:</p> <ul style="list-style-type: none"> Installation manual of the 3-way valve Addendum book for optional equipment
	<p>Wires: 3×0.75 mm²</p> <p>Maximum running current: 100 mA</p>
	[9.2] Domestic hot water
(in case of DHW tank) Domestic hot water tank thermistor	<p>See:</p> <ul style="list-style-type: none"> Installation manual of the domestic hot water tank Addendum book for optional equipment
	<p>Wires: 2</p> <p>The thermistor and connection wire (12 m) are delivered with the domestic hot water tank.</p>
	[9.2] Domestic hot water
(in case of DHW tank) Power supply for booster heater (from outdoor unit to thermal protector of booster heater)	<p>See:</p> <ul style="list-style-type: none"> Installation manual of the domestic hot water tank Addendum book for optional equipment
	<p>Wires: (2+GND)×2.5 mm²</p>
	[9.4] Booster heater
(in case of DHW tank) Power supply for booster heater (from mains to outdoor unit)	<p>See:</p> <ul style="list-style-type: none"> Installation manual of the domestic hot water tank Addendum book for optional equipment
	<p>Wires: 2+GND</p> <p>Maximum running current: 13 A</p>
	[9.4] Booster heater
WLAN cartridge	<p>See:</p> <ul style="list-style-type: none"> Installation manual of the WLAN cartridge Installer reference guide
	—
	[D] Wireless gateway
Flow switch	<p>See installation manual of the flow switch</p>
	<p>Wires: 2×0.5 mm²</p>
	—

Location extra components

The following illustration shows the location of the extra components that you need to install on the outdoor unit when using certain option kits.

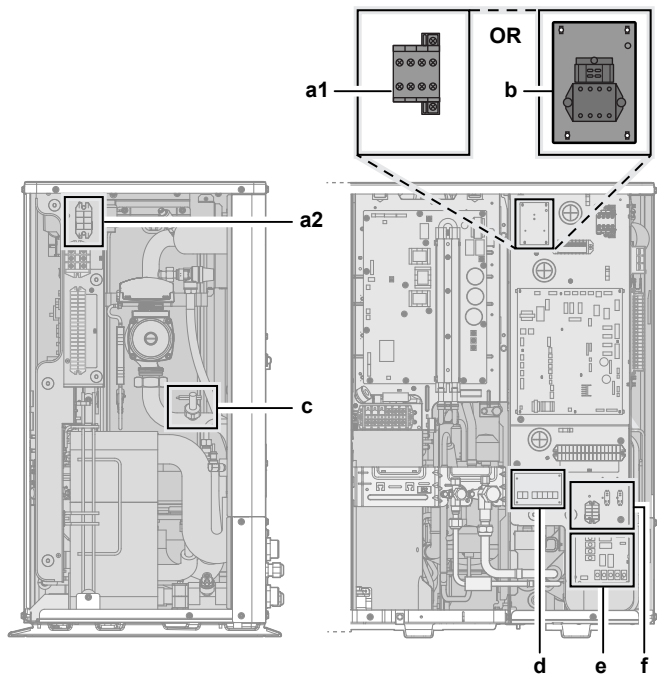

- a Accessories in standalone domestic hot water tank (EKHWS*D* and EKHWSU*D*)
 - a1: Contactor
 - a2: Terminal block
- b Connection kit for third-party tank with built-in thermostat (EKHY3PART2)
- c Flow switch (EKFLSW1)
- d Demand PCB (A8P: EKRP1AHTA)
- e Digital I/O PCB (A4P: EKRP1HBAA)
- f Smart grid relay kit (EKRELSG)

6.3.1 To connect the electrical wiring to the outdoor unit

- 1 Open the service cover. See "4.3.1 To open the outdoor unit" [8].
- 2 Insert the cables at the back of the unit, and route them through the unit to the appropriate terminal blocks.

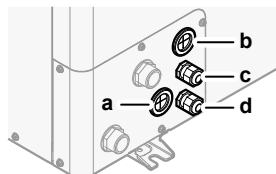

- a High voltage options
- b Low voltage options
- c Power supply for backup heater (in case of unit with integrated backup heater)
Wiring for backup heater kit (in case of external backup heater kit)
- d Unit power supply

- 3 Connect the wires to the appropriate terminals, and fix the cables with cable ties.

6.3.2 To connect the main power supply

This topic describes 2 possible ways to connect the main power supply:

- In case of normal kWh rate power supply
- In case of preferential kWh rate power supply

In case of normal kWh rate power supply

	Normal kWh rate power supply	Wires: 1N+GND, OR 3N+GND Maximum running current: Refer to name plate on unit.
---	------------------------------	---



- 1 Open the service cover. See "4.3.1 To open the outdoor unit" [▶ 8].
- 2 Connect as follows (1N~ or 3N~ depending on model, see name plate):

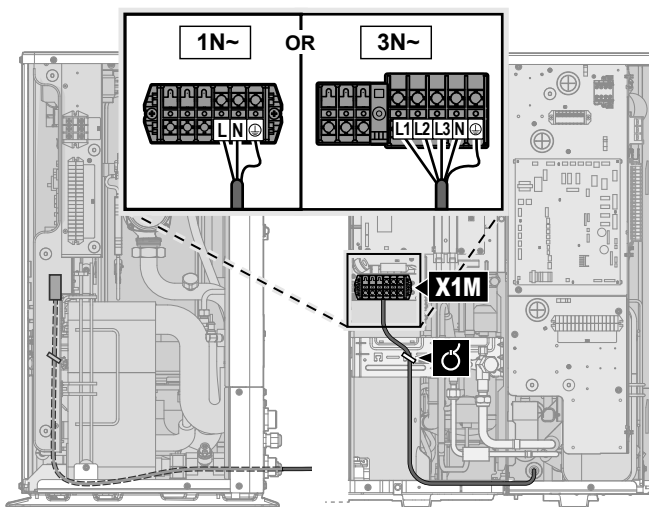
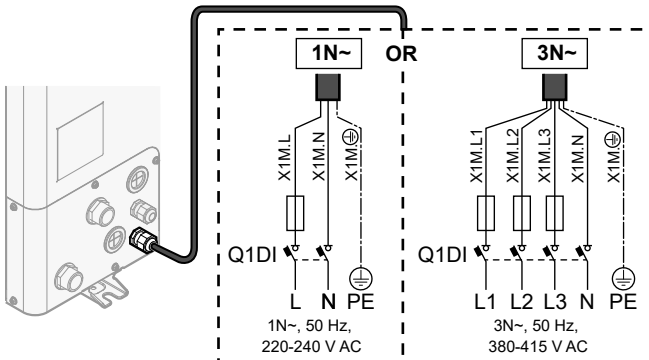

- 3 Fix the cables with cable ties to the cable tie mountings.

In case of preferential kWh rate power supply

	Preferential kWh rate power supply	Wires: 1N+GND, OR 3N+GND Maximum running current: Refer to name plate on unit.
	Separate normal kWh rate power supply	Wires: 1N Maximum running current: 6.3 A
	Preferential kWh rate power supply contact	Wires: 2×(0.75~1.25 mm ²) Maximum length: 50 m. Preferential kWh rate power supply contact: 16 V DC detection (voltage supplied by PCB). The voltage-free contact shall ensure the minimum applicable load of 15 V DC, 10 mA.
	[9.8] Benefit kWh power supply	

- 1 Open the service cover. See "4.3.1 To open the outdoor unit" [▶ 8].
- 2 Connect the preferential kWh rate power supply (1N~ or 3N~ depending on model, see name plate).

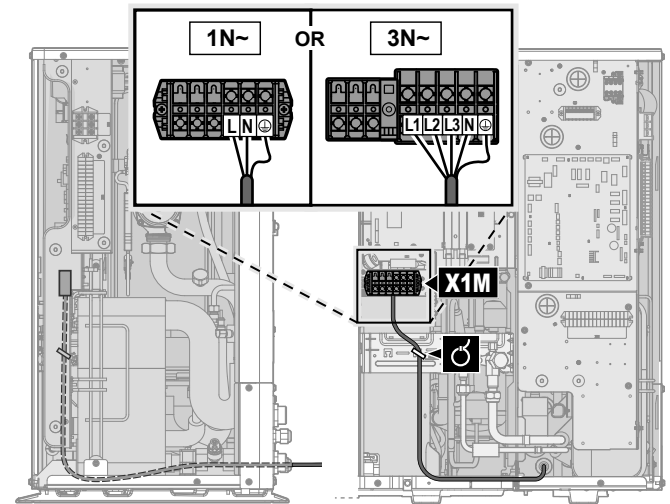
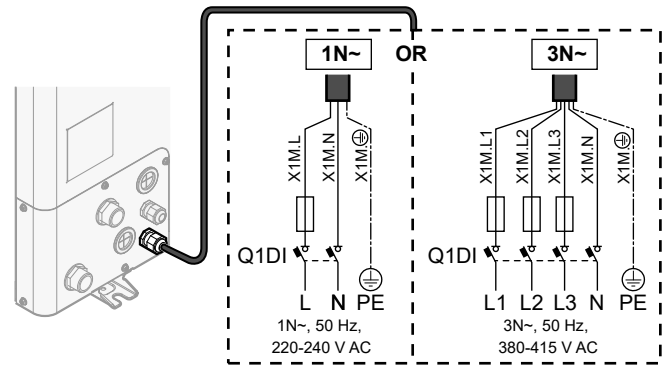

- 3 If necessary, connect the separate normal kWh rate power supply.



INFORMATION

Some types of preferential kWh rate power supply require a separate normal kWh rate power supply to the outdoor unit. This is required in the following cases:

- if the preferential kWh rate power supply is interrupted when active, OR
- if no power consumption of the hydro module of the outdoor unit is allowed at the preferential kWh rate power supply when active.

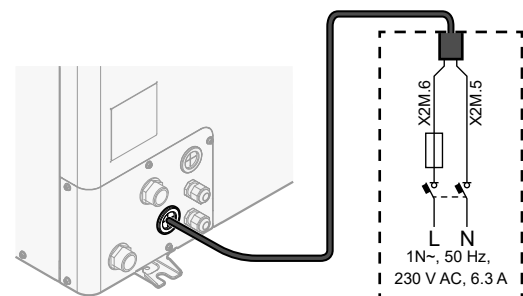

6 Electrical installation

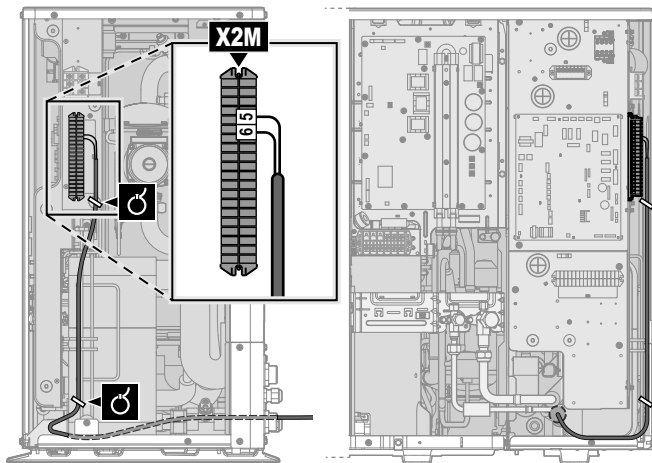

4 Connect the preferential power supply contact.

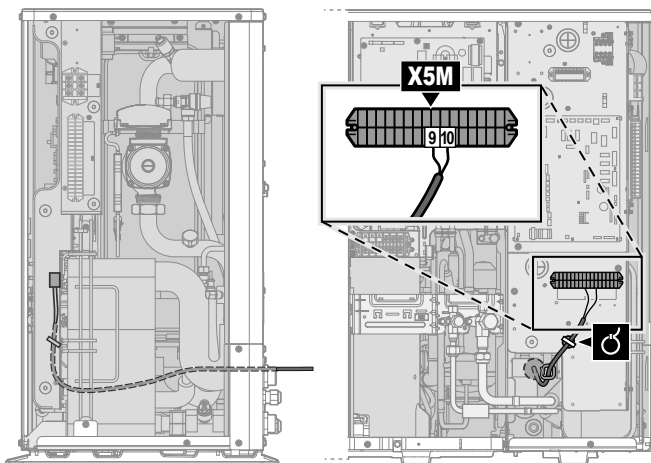
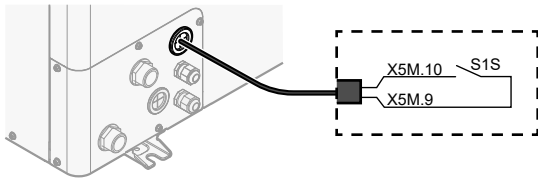

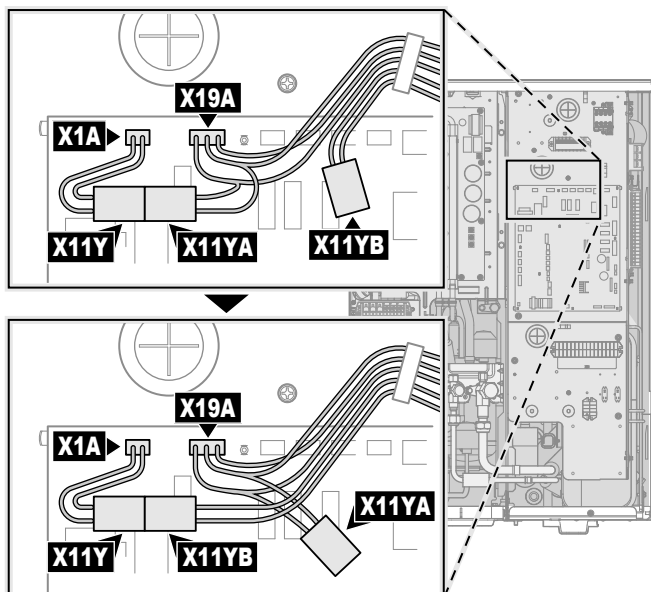

5 In case of a separate normal kWh rate power supply, disconnect X11Y from X11YA, and connect X11Y to X11YB.



6 Fix the cables with cable ties to the cable tie mountings.

6.3.3 To connect the backup heater power supply

This topic is only applicable in case of models with integrated backup heater. For instructions in case of an external backup heater kit, see "6.3.4 External backup heater kit" [▶ 17].

	Backup heater type	Power supply	Wires
	*3V	1N~ 230 V	2+GND
	[9.3] Backup heater		

WARNING
The backup heater **MUST** have a dedicated power supply and **MUST** be protected by the safety devices required by the applicable legislation.

CAUTION
To guarantee the unit is completely earthed, **ALWAYS** connect the backup heater power supply and the earth cable.

Connect the power supply of the backup heater as follows:

- 1 Open the service cover. See "4.3.1 To open the outdoor unit" [▶ 8].
- 2 Connect the power supply cable (including earth) to the appropriate terminals as shown in the illustration below.

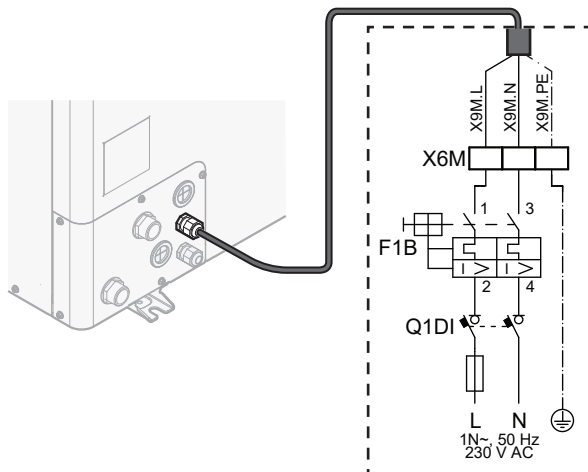

F1B Overcurrent fuse (field supply). Recommended fuse: 2-pole; 16 A; curve 400 V; tripping class C.

Q1DI Earth leakage circuit breaker (field supply)

X6M Terminal (field supply)

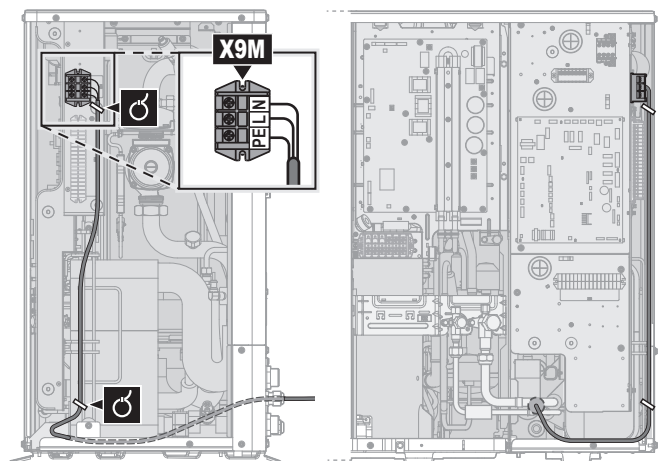

3 Fix the cable with cable ties to the cable tie mountings.

6.3.4 External backup heater kit

For models without integrated backup heater, you can install the external backup heater kit (EKLBHUHCB6W1).

If you do so, then under certain conditions you also need to install a bypass valve kit (EKMBHBP1).



See:

- "To connect the backup heater kit" [17]
- "Bypass valve kit necessity" [18]
- "To connect the bypass valve kit" [19]

To connect the backup heater kit

The installation of the external backup heater kit is described in the installation manual of the kit. However, certain parts of it are superseded by the information described here. It concerns the following:

- To connect the backup heater kit power supply
- To connect the backup heater kit to the outdoor unit

	Wires: See installation manual of the backup heater kit
	[9.3] Backup heater

To connect the backup heater kit power supply



CAUTION

To guarantee the unit is completely earthed, ALWAYS connect the backup heater power supply and the earth cable.



WARNING

The backup heater MUST have a dedicated power supply and MUST be protected by the safety devices required by the applicable legislation.

Depending on the configuration (wiring on X14M, and settings in [9.3] Backup heater), the backup heater capacity can vary. Make sure that the power supply is in accordance with the backup heater capacity, as listed in the table below.

Backup heater type	Backup heater capacity	Power supply	Maximum running current	Z _{max} (Ω)
*6W	3 kW	1N~ 230 V	13 A	—
	6 kW	1N~ 230 V	26 A ^{(a)(b)}	—
	6 kW	3N~ 400 V	8.6 A	—
	9 kW	3N~ 400 V	13 A	—

^(a) This equipment complies with EN/IEC 61000-3-11 (European/ International Technical Standard setting the limits for voltage changes, voltage fluctuations and flicker in public low-voltage supply systems for equipment with rated current ≤75 A) provided that the system impedance Z_{sys} is less than or equal to Z_{max} at the interface point between the user's supply and the public system. It is the responsibility of the installer or user of the equipment to ensure, by consultation with the distribution network operator if necessary, that the equipment is connected only to a supply with a system impedance Z_{sys} less than or equal to Z_{max}.

^(b) Electrical equipment complying with EN/IEC 61000-3-12 (European/International Technical Standard setting the limits for harmonic currents produced by equipment connected to public low-voltage systems with input current >16 A and ≤75 A per phase).

- 1 Connect the backup heater power supply. A 4-pole fuse is used for F1B.
- 2 If required, modify the connection on terminal X14M.

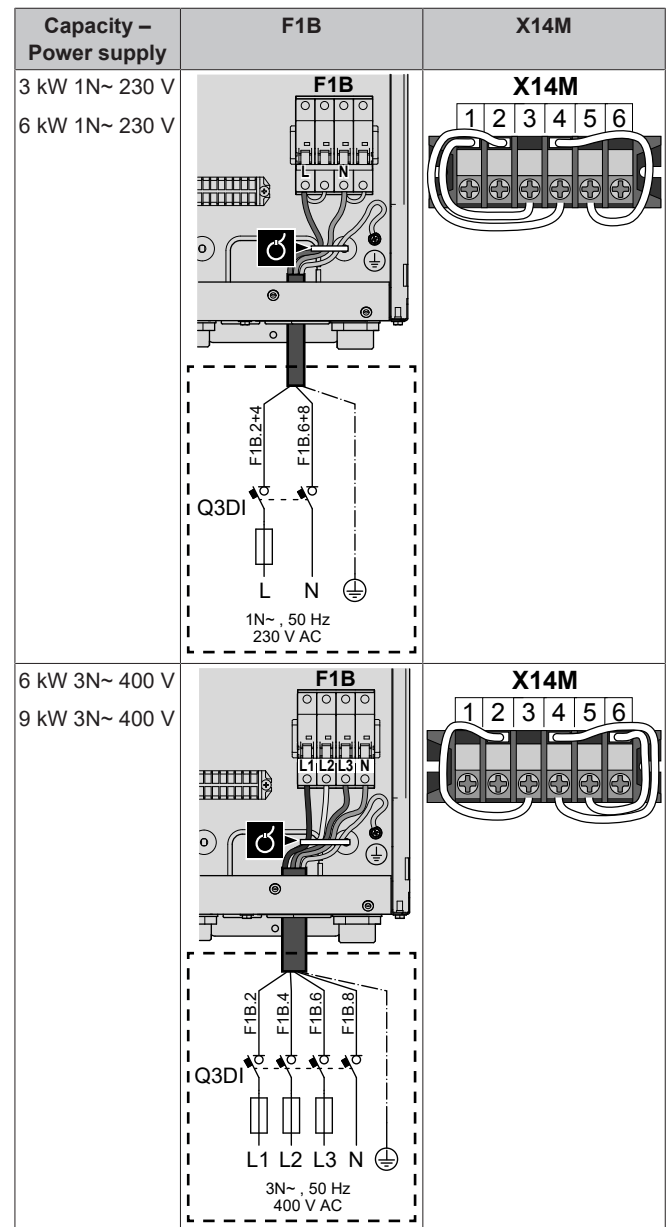

3 Fix the cable with cable ties to the cable tie mountings.

During connection of the backup heater, miswiring is possible. To detect possible miswiring, it is highly recommended to measure the resistance value of the heater elements. Depending on the capacity and power supply, following resistance values (see table below) should be measured. ALWAYS measure the resistance on the contactor clamps K1M, K2M, and K5M.

		3 kW 1N~ 230 V	6 kW 1N~ 230 V	6 kW 3N~ 400 V	9 kW 3N~ 400 V
K1M/1	K5M/13	52.9Ω	52.9Ω	∞	∞
	K1M/3	∞	105.8Ω	105.8Ω	105.8Ω
	K1M/5	∞	158.7Ω	105.8Ω	105.8Ω
K1M/3	K1M/5	26.5Ω	52.9Ω	105.8Ω	105.8Ω
K2M/1	K5M/13	∞	26.5Ω	∞	∞
	K2M/3	∞	∞	52.9Ω	52.9Ω
	K2M/5	∞	∞	52.9Ω	52.9Ω
K2M/3	K2M/5	52.9Ω	52.9Ω	52.9Ω	52.9Ω
K1M/5	K2M/1	∞	132.3Ω	∞	∞

Example measure resistance between K1M/1 and K5M/13:

6 Electrical installation

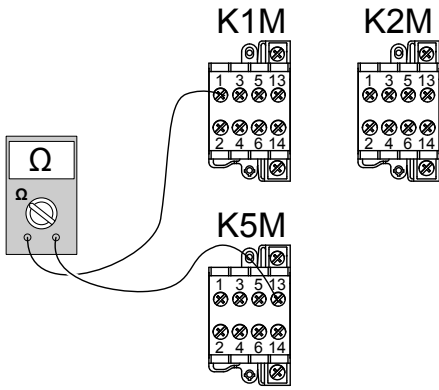

To connect the backup heater kit to the outdoor unit

The wiring between the backup heater kit and the outdoor unit is as follows:

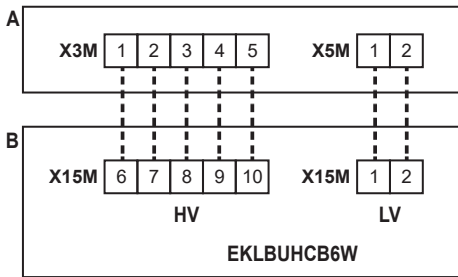

- A Outdoor unit
- B Backup heater kit
- HV High voltage connections (backup heater thermal protector + backup heater connection)
- LV Low voltage connection (backup heater thermistor)

NOTICE

The distance between the high voltage and low voltage cables should be at least 50 mm.

- 1 On the backup heater kit, connect the LV and HV cables to the appropriate terminals as shown in the illustration below.

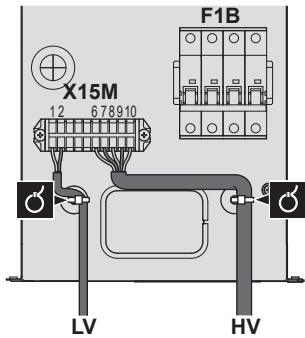

- 2 On the outdoor unit, connect the HV cable to the appropriate terminals as shown in the illustration below.

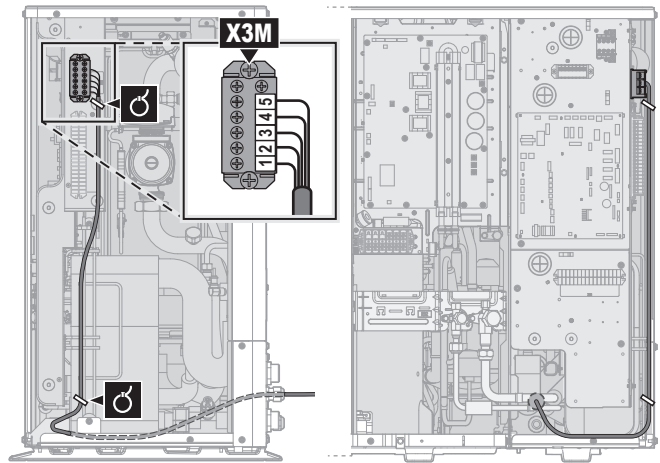
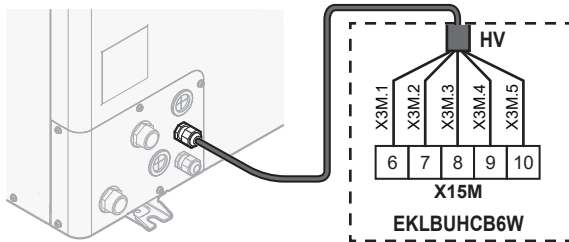

- 3 On the outdoor unit, connect the LV cable to the appropriate terminals as shown in the illustration below.

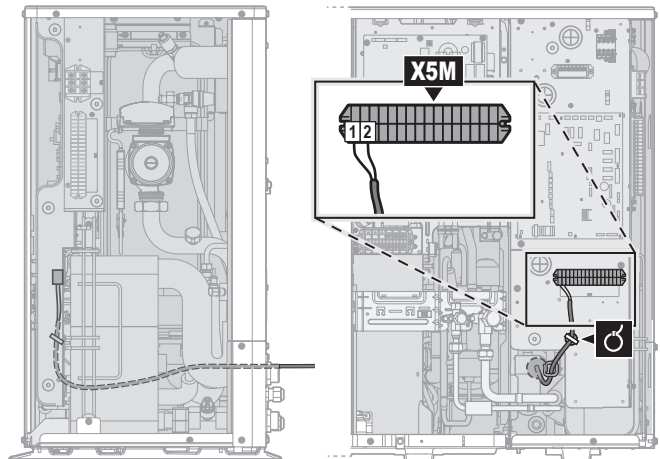
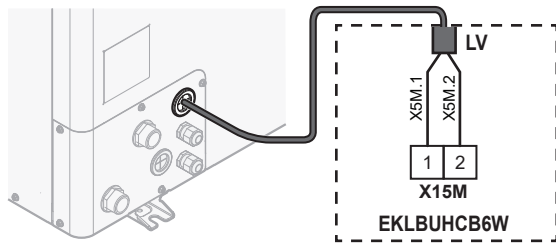

- 4 Fix the cables with cable ties to the cable tie mountings.

Bypass valve kit necessity

For reversible systems (heating+cooling) in which an external backup heater kit is installed, the installation of valve kit EKMBHBP1 is required if condensation is expected inside the backup heater.

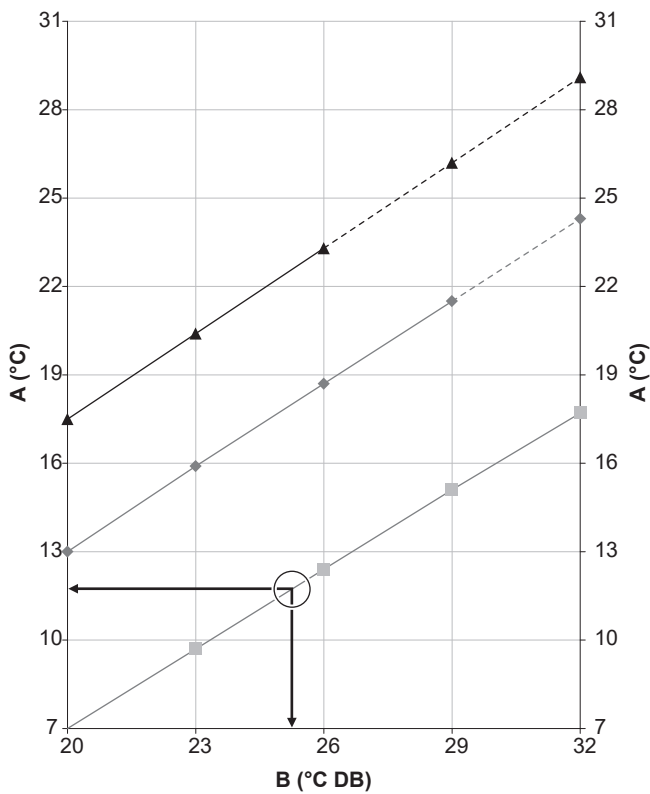

- A** Leaving water evaporator temperature
- B** Dry-bulb temperature
- Relative humidity 40%
- ◆ Relative humidity 60%
- ▲ Relative humidity 80%

Example: Given are an ambient temperature of 25°C and a relative humidity of 40%. If the leaving water evaporator temperature is <12°C, condensation will occur.

Note: See the psychrometric chart for more information.

To connect the bypass valve kit

The information in this topic supersedes that of the instruction sheet delivered with the bypass valve kit.

	Wires: 3×0.75 mm ²
	—

The components of the bypass valve kit are as follows. You only need **B** and **D**.

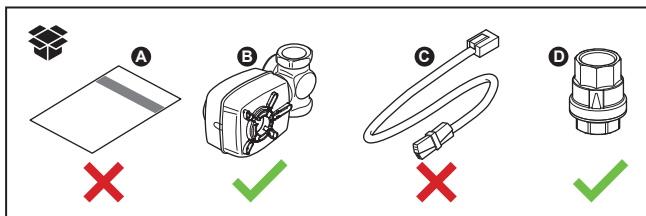

1 Integrate components **B** and **D** as follows in the system:

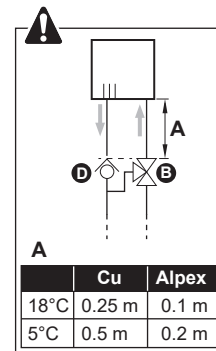
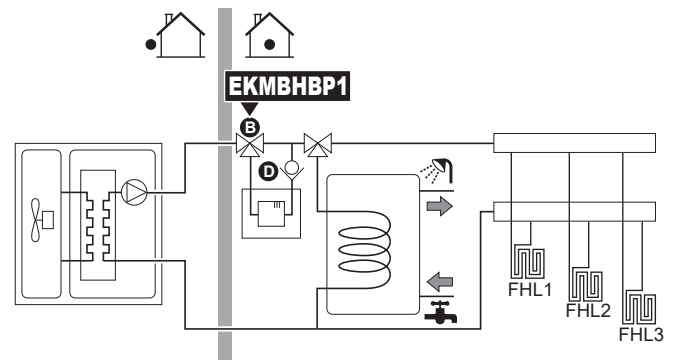

2 On the outdoor unit, connect **B** to the appropriate terminals as shown in the illustration below.

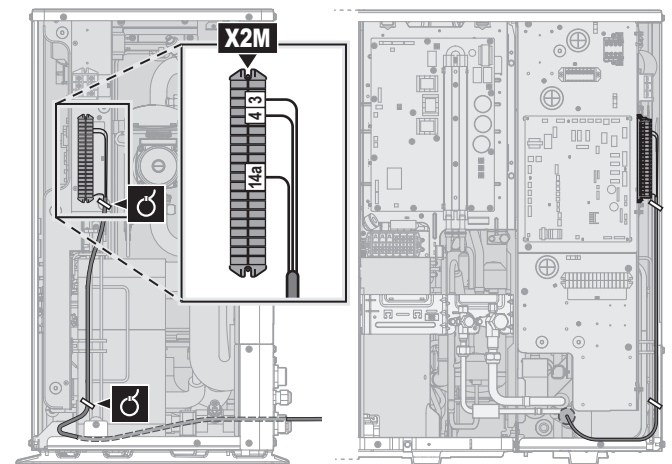
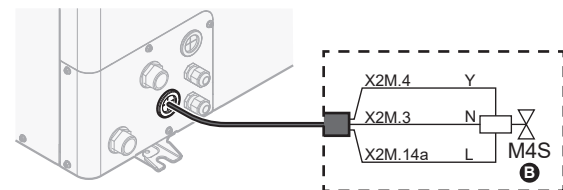

3 Fix the cable with cable ties to the cable tie mountings.

6.3.5 To connect the user interface

This topic describes the following:

- Connecting the user interface cable to the outdoor unit.
- Installing the user interface, and connecting the user interface cable to it.
- (if necessary) Opening the user interface after it is installed.

Connecting the user interface cable to the outdoor unit

	Wires: 4×(0.75~1.25 mm ²)
	Maximum length: 200 m

6 Electrical installation



[2.9] Control

[1.6] Room sensor offset

- 1 Open the service cover. See "4.3.1 To open the outdoor unit" ▶ 8].
- 2 Connect the user interface cable to the outdoor unit. Fix the cable with cable ties to the cable tie mountings.

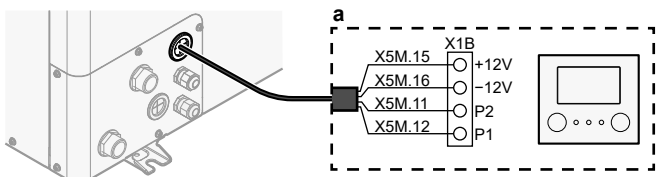

a User interface: Required for operation. Delivered with the unit as accessory.

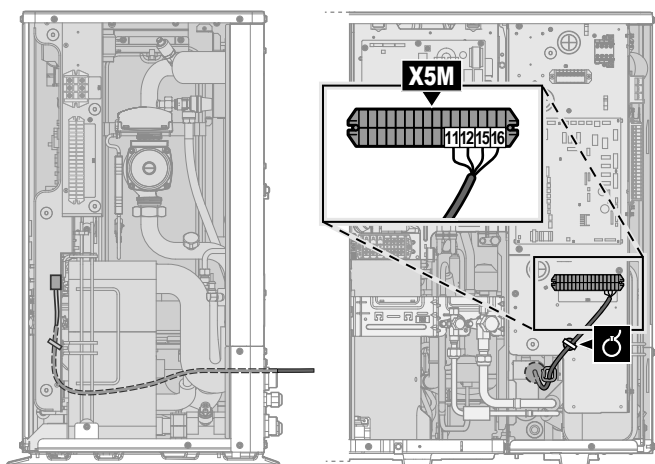

Installing the user interface, and connecting the user interface cable to it

You need the following user interface accessories (delivered on top of the unit):

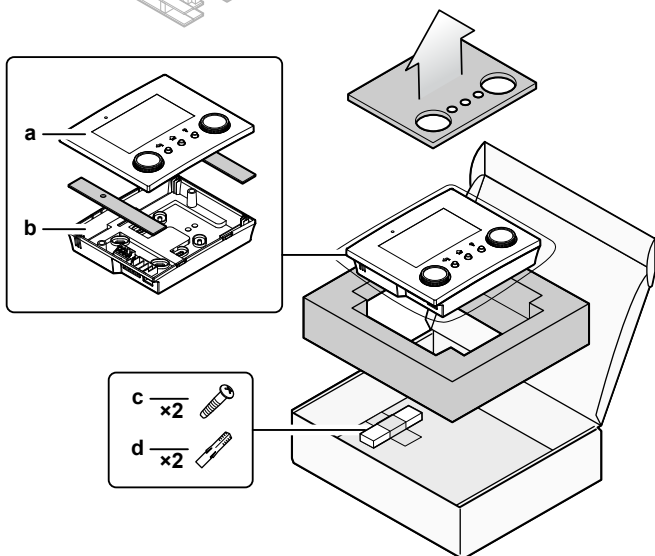
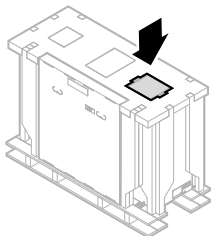

a Front plate

- b Rear plate
- c Screws
- d Wall plugs

- 1 Mount the rear plate to the wall.
 - Use the 2 screws and wall plugs.
 - Use any of the 6 holes. The holes are compatible with standard electrical box extenders of 60 mm.

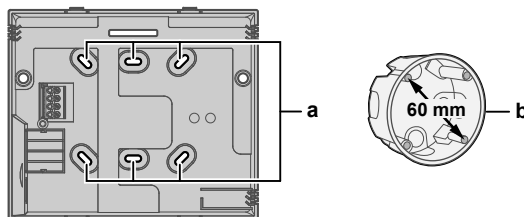

- a Holes
- b Electrical box extender (field supply)

- 2 Connect the user interface cable to the user interface.
 - Choose one of the 4 possible wiring intakes (a, b, c or d).
 - If you choose the left or right side, make a hole for the cable in the part of the casing where the casing is thinner.

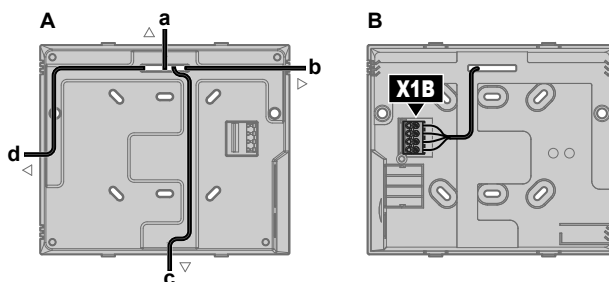
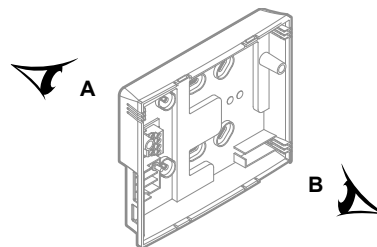

- a Top side
- b Left side
- c Bottom side
- d Right side

- 3 Mount the front plate.
 - Align the positioning pins and push the front plate onto the rear plate until it moves into place with a click.
 - The connector pins are automatically inserted correctly.

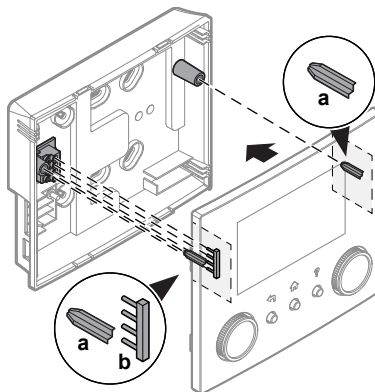

- a Positioning pins
- b Connector pins

Opening the user interface after it is installed

If you need to open the user interface after it is installed, proceed as follows:

- 1 Remove the WLAN cartridge and USB memory stick (if any).

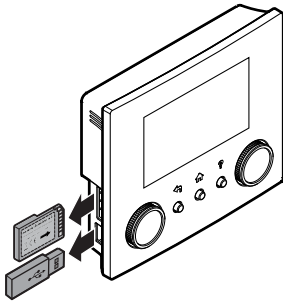

- 2 Push the rear plate on each of the 4 spots where the snap-fits are located.

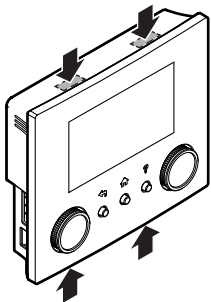

6.3.6 To connect the shut-off valve

i INFORMATION

Shut-off valve usage example. In case of one LWT zone, and a combination of underfloor heating and heat pump convectors, install a shut-off valve before the underfloor heating to prevent condensation on the floor during cooling operation.

	Wires: 2×0.75 mm ²
	Maximum running current: 100 mA
	230 V AC supplied by PCB
	—

- 1 Open the service cover. See "[4.3.1 To open the outdoor unit](#)" [▶ 8].
- 2 Connect the valve control cable to the appropriate terminals as shown in the illustration below.

! NOTICE

Only connect NO (normally open) valves.

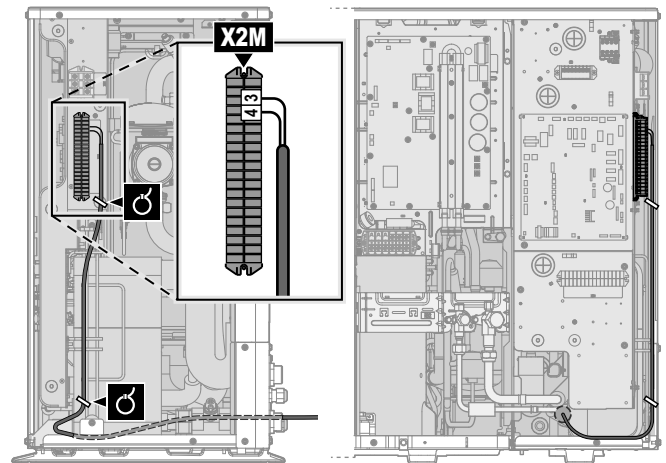
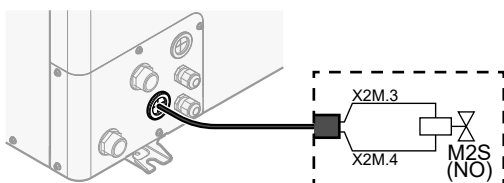

- 3 Fix the cable with cable ties to the cable tie mountings.

6.3.7 To connect the electricity meters

	Wires: 2 (per meter)×0.75 mm ²
	Electricity meters: 12 V DC pulse detection (voltage supplied by PCB)
	[9.A] Energy metering

i INFORMATION

In case of an electricity meter with transistor output, check the polarity. The positive polarity **MUST** be connected to X5M/6 and X5M/4; the negative polarity to X5M/5 and X5M/3.

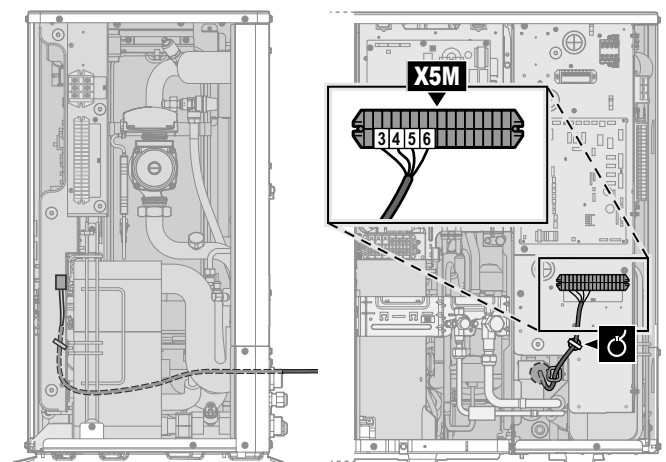
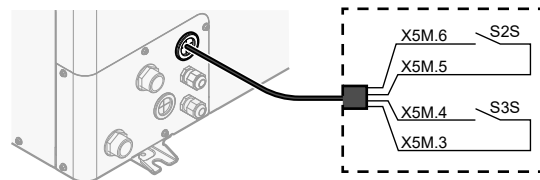

- 1 Open the service cover. See "[4.3.1 To open the outdoor unit](#)" [▶ 8].
- 2 Connect the electricity meters cable to the appropriate terminals as shown in the illustration below.



- 3 Fix the cable with cable ties to the cable tie mountings.

6 Electrical installation

6.3.8 To connect the domestic hot water pump

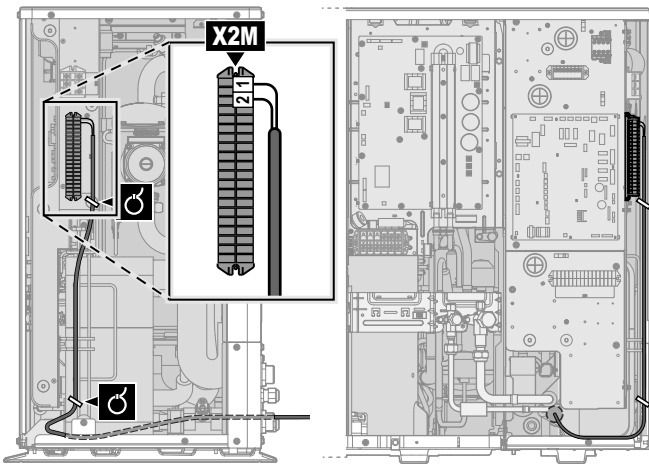
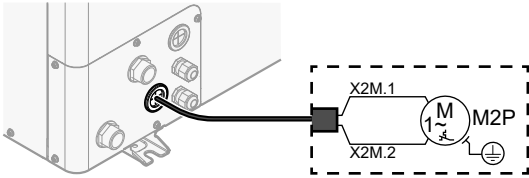

	Wires: (2+GND)×0.75 mm ²
	DHW pump output. Maximum load: 2 A (inrush), 230 V AC, 1 A (continuous)
	[9.2.2] DHW pump [9.2.3] DHW pump schedule

- 1 Open the service cover. See "4.3.1 To open the outdoor unit" ▸ 8].
- 2 Connect the domestic hot water pump cable to the appropriate terminals as shown in the illustration below.



- 3 Fix the cable with cable ties to the cable tie mountings.

6.3.9 To connect the alarm output

	Wires: (2+1)×0.75 mm ²
	Maximum load: 0.3 A, 250 V AC
	[9.D] Alarm output

- 1 Open the service cover. See "4.3.1 To open the outdoor unit" ▸ 8].
- 2 Connect the alarm output cable to the appropriate terminals as shown in the illustration below.

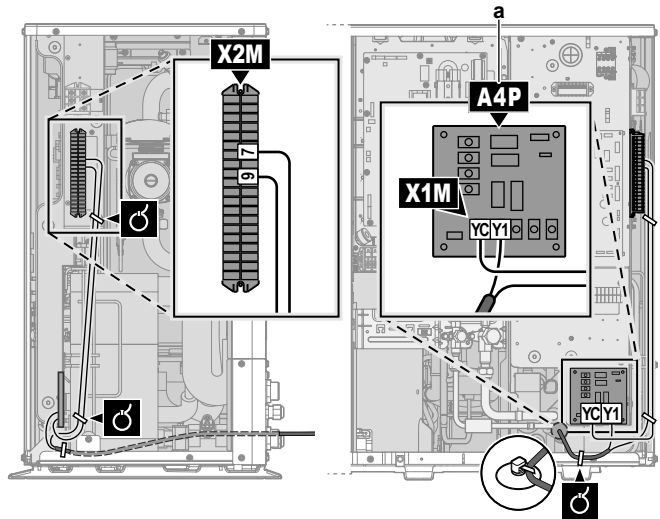
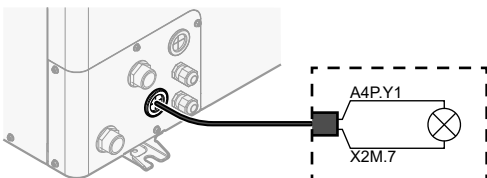
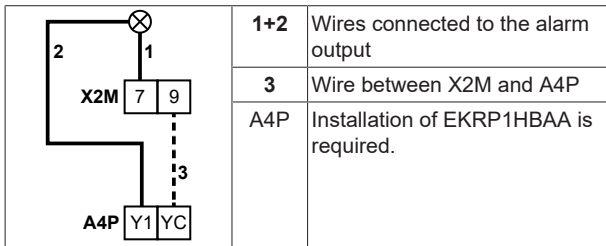

a Installation of EKR1HBAA is required.



WARNING

Stripped wire. Make sure that stripped wire cannot make contact with possible water on the bottom plate.



- 3 Fix the cable with cable ties to the cable tie mountings.

6.3.10 To connect the space cooling/heating ON/OFF output



INFORMATION

Cooling is only applicable in case of reversible models.

	Wires: (2+1)×0.75 mm ²
	Maximum load: 0.3 A, 250 V AC
	—

- 1 Open the service cover. See "4.3.1 To open the outdoor unit" ▸ 8].
- 2 Connect the space cooling/heating ON/OFF output cable to the appropriate terminals as shown in the illustration below.

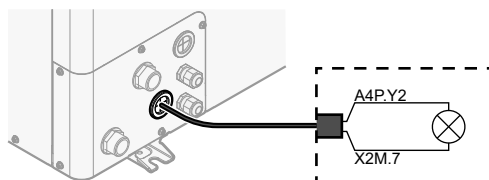
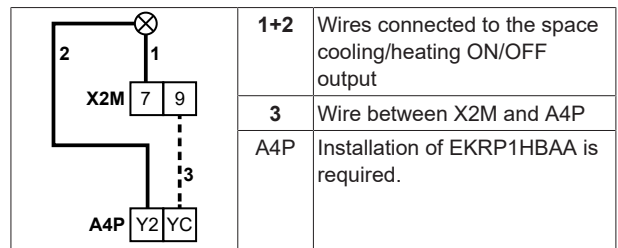

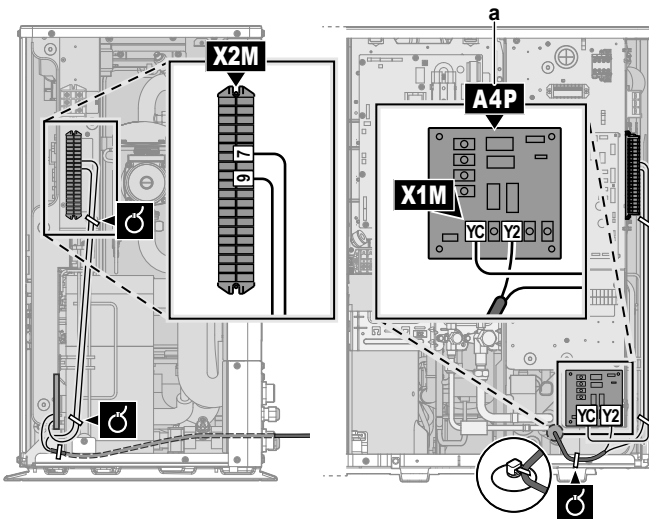

a Installation of EKR1HBAA is required.



WARNING

Stripped wire. Make sure that stripped wire cannot make contact with possible water on the bottom plate.

- 3 Fix the cable with cable ties to the cable tie mountings.

6.3.11 To connect the changeover to external heat source



INFORMATION

Bivalent is only possible in case of 1 leaving water temperature zone with:

- room thermostat control, OR
- external room thermostat control.

	Wires: 2×0.75 mm ²
	Maximum load: 0.3 A, 250 V AC
	Minimum load: 20 mA, 5 V DC
	[9.C] Bivalent

- 1 Open the service cover. See "4.3.1 To open the outdoor unit" [8].
- 2 Connect the changeover to external heat source cable to the appropriate terminals as shown in the illustration below.

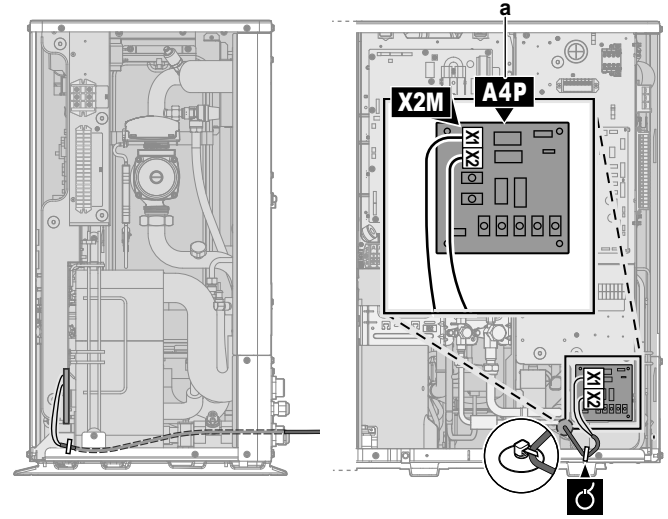
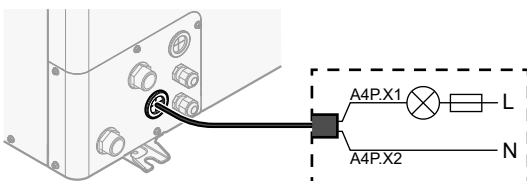

a Installation of EKR1AHTA is required.

- 3 Fix the cable with cable ties to the cable tie mountings.

6.3.12 To connect the power consumption digital inputs

	Wires: 2 (per input signal)×0.75 mm ²
	Power limitation digital inputs: 12 V DC / 12 mA detection (voltage supplied by PCB)
	[9.9] Power consumption control.

- 1 Open the service cover. See "4.3.1 To open the outdoor unit" [8].
- 2 Connect the power consumption digital inputs cable to the appropriate terminals as shown in the illustration below.

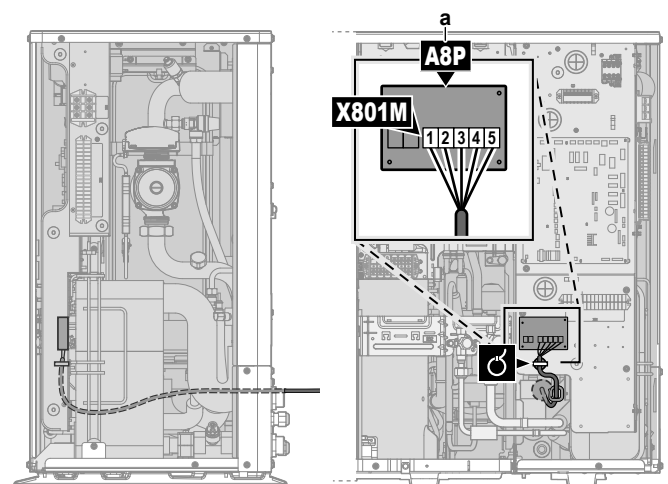
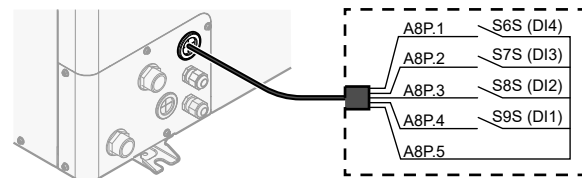



a Installation of EKR1AHTA is required.

- 3 Fix the cable with cable ties to the cable tie mountings.

6 Electrical installation

6.3.13 To connect the safety thermostat (normally closed contact)

	Wires: 2×0.75 mm ² Maximum length: 50 m Safety thermostat contact: 16 V DC detection (voltage supplied by PCB). The voltage-free contact shall ensure the minimum applicable load of 15 V DC, 10 mA.
	—

- 1 Open the service cover. See "4.3.1 To open the outdoor unit" [▶ 8].
- 2 Connect the safety thermostat (normally closed) cable to the appropriate terminals as shown in the illustration below.

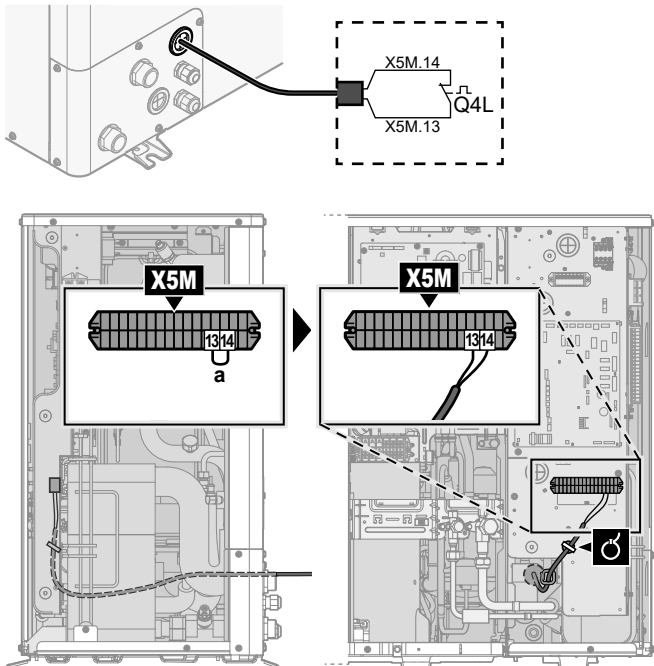

a Remove jumper

- 3 Fix the cable with cable ties to the cable tie mountings.

NOTICE

Make sure to select and install the safety thermostat according to the applicable legislation.

In any case, to prevent unnecessary tripping of the safety thermostat, we recommend the following:

- The safety thermostat is automatically resettable.
- The safety thermostat has a maximum temperature variation rate of 2°C/min.
- There is a minimum distance of 2 m between the safety thermostat and the motorized 3-way valve delivered with the domestic hot water tank.

NOTICE

Error. If you remove the jumper (open circuit) but do NOT connect the safety thermostat, stop error 8H-03 will occur.

6.3.14 To connect a Smart Grid

This topic describes 2 possible ways to connect the outdoor unit to a Smart Grid:

- In case of low voltage Smart Grid contacts
- In case of high voltage Smart Grid contacts. This requires the installation of the Smart Grid relay kit (EKRELSG).



The 2 incoming Smart Grid contacts can activate the following Smart Grid modes:

Smart Grid contact		Smart Grid operation mode
①	②	
0	0	Free running
0	1	Forced off
1	0	Recommended on
1	1	Forced on

The use of a Smart Grid pulse meter is not mandatory:

If Smart Grid pulse meter is...	Then [9.8.8] Limit setting kW is...
Used ([9.A.2] Electricity meter 2 ≠ None)	Not applicable
Not used ([9.A.2] Electricity meter 2 = None)	Applicable

In case of low voltage Smart Grid contacts

	Wires (Smart Grid pulse meter): 0.5 mm ² Wires (low voltage Smart Grid contacts): 0.5 mm ²
	[9.8.4]=3 (Benefit kWh power supply = Smart Grid) [9.8.5] Smart Grid operation mode [9.8.6] Allow electrical heaters [9.8.7] Enable room buffering [9.8.8] Limit setting kW

The wiring of the Smart Grid in case of low voltage contacts is as follows:

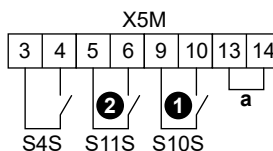

- a Jumper (factory-mounted). If you also connect a safety thermostat (Q4L), replace the jumper with the safety thermostat wires.

- ①/S4S Smart Grid pulse meter (optional)
- ①/S10S Low voltage Smart Grid contact 1
- ②/S11S Low voltage Smart Grid contact 2

- 1 Open the service cover. See "4.3.1 To open the outdoor unit" [▶ 8].
- 2 Connect the wiring as follows:

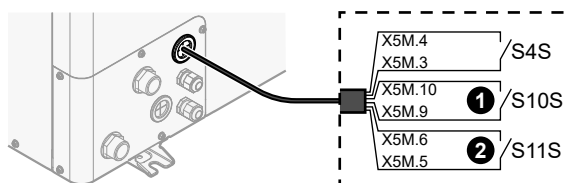

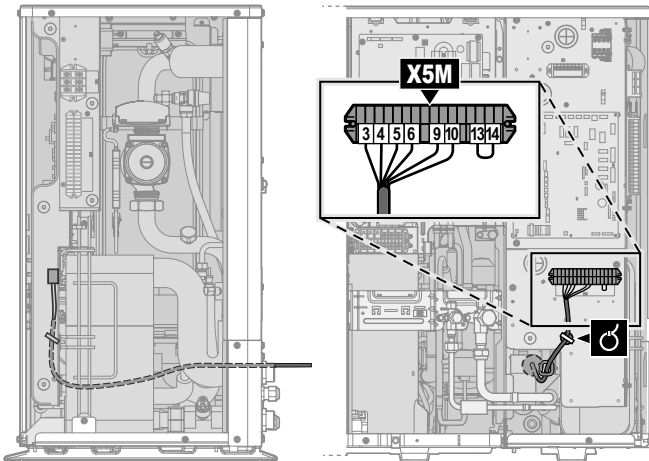

3 Fix the cables with cable ties to the cable tie mountings.

In case of high voltage Smart Grid contacts

	Wires (Smart Grid pulse meter): 0.5 mm ²
	Wires (high voltage Smart Grid contacts): 1 mm ²
	[9.8.4]=3 (Benefit kWh power supply = Smart Grid)
	[9.8.5] Smart Grid operation mode
	[9.8.6] Allow electrical heaters
	[9.8.7] Enable room buffering
	[9.8.8] Limit setting kW

The wiring of the Smart Grid in case of high voltage contacts is as follows:

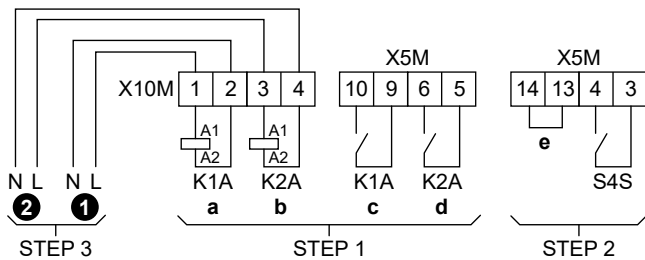

- STEP 1 Smart Grid relay kit installation
- STEP 2 Low voltage connections
- STEP 3 High voltage connections
- ① High voltage Smart Grid contact 1
- ② High voltage Smart Grid contact 2
- K1A Relay for Smart Grid contact 1
- K2A Relay for Smart Grid contact 2
- a, b Coil sides of relays
- c, d Contact sides of relays
- e Jumper (factory-mounted). If you also connect a safety thermostat (Q4L), replace the jumper with the safety thermostat wires.
- S4S Smart Grid pulse meter (optional)

1 Install the components of the Smart Grid relay kit as follows:

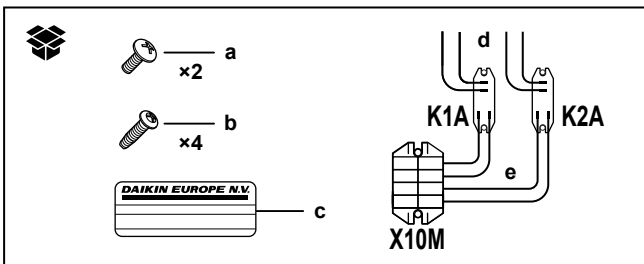

- K1A Relay for Smart Grid contact 1
- K2A Relay for Smart Grid contact 2
- X10M Terminal block
- a Screws for X10M
- b Screws for K1A and K2A

- c Sticker to put on the high voltage wires
- d Wires between the relays and X5M (AWG22 ORG)
- e Wires between the relays and X10M (AWG18 RED)

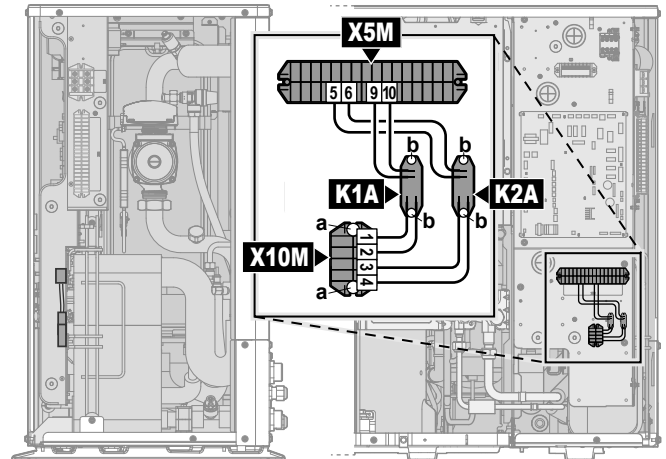

2 Connect the low voltage wiring as follows:

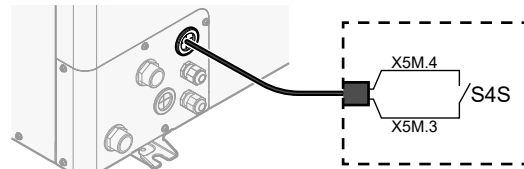

S4S Smart Grid pulse meter (optional)

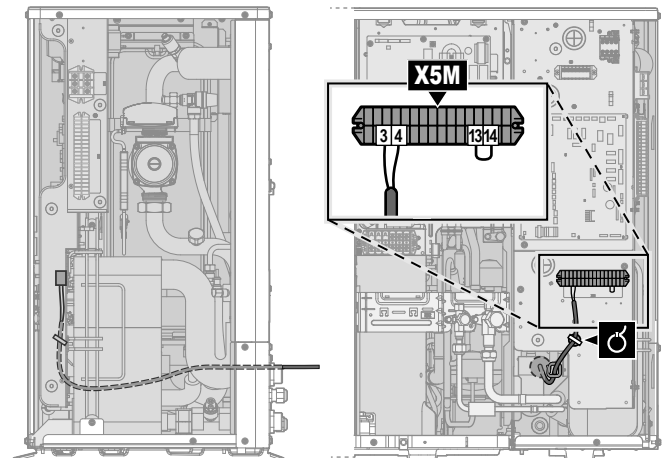

3 Connect the high voltage wiring as follows:

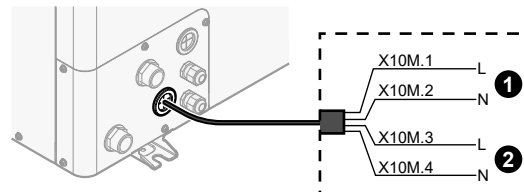

- ① High voltage Smart Grid contact 1
- ② High voltage Smart Grid contact 2

7 Finishing the outdoor unit installation

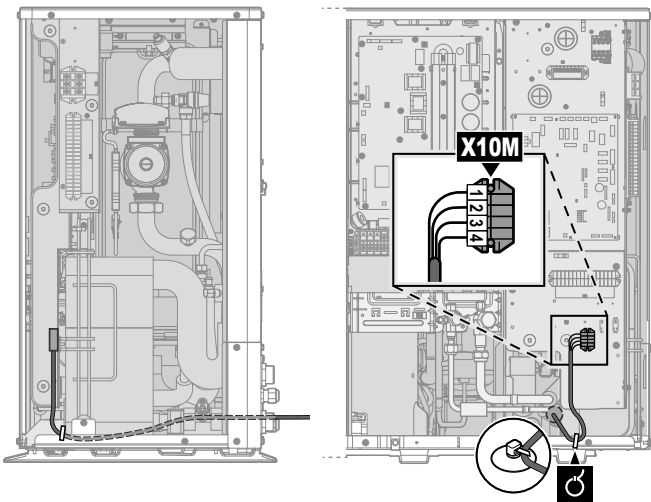

- Fix the cables with cable ties to the cable tie mountings. If necessary, bundle excessive cable length with a cable tie.

7 Finishing the outdoor unit installation

7.1 To check the insulation resistance of the compressor



NOTICE

If, after installation, refrigerant accumulates in the compressor, the insulation resistance over the poles can drop, but if it is at least 1 MΩ, then the unit will not break down.

- Use a 500 V mega-tester when measuring insulation.
- Do NOT use a mega-tester for low voltage circuits.

- Measure the insulation resistance over the poles.

If	Then
≥1 MΩ	Insulation resistance is OK. This procedure is finished.
<1 MΩ	Insulation resistance is not OK. Go to the next step.

- Turn ON the power and leave it on for 6 hours.

Result: The compressor will heat up and evaporate any refrigerant in the compressor.

- Measure the insulation resistance again.

8 Configuration



INFORMATION

Cooling is only applicable in case of reversible models.

8.1 Overview: Configuration

This chapter describes what you have to do and know to configure the system after it is installed.



NOTICE

This chapter explains only the basic configuration. For more detailed explanation and background information, see the installer reference guide.

Why

If you do NOT configure the system correctly, it might NOT work as expected. The configuration influences the following:

- The calculations of the software
- What you can see on and do with the user interface

How

You can configure the system via the user interface.

- First time – Configuration wizard.** When you turn ON the user interface for the first time (via the unit), the configuration wizard starts to help you configure the system.
- Restart the configuration wizard.** If the system is already configured, you can restart the configuration wizard. To restart the configuration wizard, go to **Installer settings > Configuration wizard**. To access **Installer settings**, see ["8.1.1 To access the most used commands"](#) [▶ 26].
- Afterwards.** If necessary, you can make changes to the configuration in the menu structure or the overview settings.



INFORMATION

When the configuration wizard is finished, the user interface will show an overview screen and request to confirm. When confirmed, the system will restart and the home screen will be displayed.

Accessing settings – Legend for tables

You can access the installer settings using two different methods. However, NOT all settings are accessible via both methods. If so, the corresponding table columns in this chapter are set to N/A (not applicable).

Method	Column in tables
Accessing settings via the breadcrumb in the home menu screen or the menu structure . To enable breadcrumbs, press the ? button in the home screen.	# For example: [2.9]
Accessing settings via the code in the overview field settings .	Code For example: [C-07]

See also:

- ["To access the installer settings"](#) [▶ 27]
- ["8.5 Menu structure: Overview installer settings"](#) [▶ 35]

8.1.1 To access the most used commands

To change the user permission level

You can change the user permission level as follows:

1	Go to [B]: User profile.	
2	Enter the applicable pin code for the user permission level.	—
	<ul style="list-style-type: none"> Browse through the list of digits and change the selected digit. 	
	<ul style="list-style-type: none"> Move the cursor from left to right. 	
	<ul style="list-style-type: none"> Confirm the pin code and proceed. 	

Installer pin code

The Installer pin code is **5678**. Additional menu items and installer settings are now available.

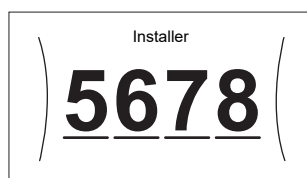

Advanced user pin code

The Advanced user pin code is **1234**. Additional menu items for the user are now visible.

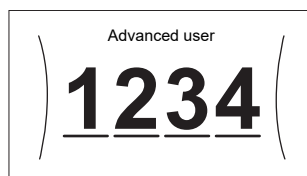

User pin code

The User pin code is **0000**.

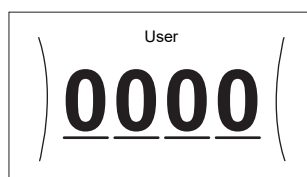

To access the installer settings

- 1 Set the user permission level to Installer.
- 2 Go to [9]: Installer settings.

To modify an overview setting

Example: Modify [1-01] from 15 to 20.

Most settings can be configured via the menu structure. If for any reason it is required to change a setting using the overview settings, then the overview settings can be accessed as follows:

1	Set the user permission level to Installer. See " To change the user permission level " [▶ 26].	—
2	Go to [9.1]: Installer settings > Overview field settings.	
3	Turn the left dial to select the first part of the setting and confirm by pressing the dial.	
4	Turn the left dial to select the second part of the setting	
5	Turn the right dial to modify the value from 15 to 20.	
6	Press the left dial to confirm the new setting.	

7	Press the center button to go back to the home screen.	
---	--	--

INFORMATION

When you change the overview settings and you go back to the home screen, the user interface will show a popup screen and request to restart the system.

When confirmed, the system will restart and recent changes will be applied.

8.2 Configuration wizard

After first power ON of the system, the user interface starts a configuration wizard. Use this wizard to set the most important initial settings for the unit to run properly. If required, you can afterwards configure more settings. You can change all these settings via the menu structure.

8.2.1 Configuration wizard: Language

#	Code	Description
[7.1]	N/A	Language

8.2.2 Configuration wizard: Time and date

#	Code	Description
[7.2]	N/A	Set the local time and date

INFORMATION

By default, daylight savings time is enabled and clock format is set to 24 hours. These settings can be changed during initial configuration or via the menu structure [7.2]: User settings > Time/date.

8.2.3 Configuration wizard: System

Backup heater type

- For models with integrated backup heater, this is fixed to 3V.
- For other models, this can be set to No heater, or External heater (i.e. when the optional external backup heater kit is installed).

#	Code	Description
[9.3.1]	[E-03]	<ul style="list-style-type: none"> • 0: No heater • 1: External heater • 2: 3V

Domestic hot water

The following setting determines if the system can prepare domestic hot water or not, and which tank is used. Set this setting according to the actual installation.

#	Code	Description
[9.2.1]	[E-05] ^(a) [E-06] ^(a) [E-07] ^(a)	<ul style="list-style-type: none"> • No DHW • No tank installed. • EKHWS/E Tank with booster heater installed at the side of the tank. • EKHWP/HYC Tank with optional booster heater installed at the top of the tank.

- ^(a) Use the menu structure instead of the overview settings. Menu structure setting [9.2.1] replaces the following 3 overview settings:
- [E-05]: Can the system prepare domestic hot water?
 - [E-06]: Is a domestic hot water tank installed in the system?
 - [E-07]: What kind of domestic hot water tank is installed?

8 Configuration

In case of EKHWP, we recommend to use the following settings:

#	Code	Item	EKHWP
[9.2.1]	[E-07]	Tank type	5: EKHWP/HYC
N/A	[4-05]	Thermistor type	0: Automatic
[5.8]	[6-0E]	Maximum tank temperature	≤70°C

In case of EKHWS*D* / EKHWSU*D*, we recommend to use the following settings:

#	Code	Item	EKHWS*D* / EKHWSU*D*
[9.2.1]	[E-07]	Tank type	0: EKHWS/E
N/A	[4-05]	Thermistor type	0: Automatic
[5.8]	[6-0E]	Maximum tank temperature	≤75°C

In case of a third-party tank, we recommend to use the following settings:

#	Code	Item	Third-party tank
[9.2.1]	[E-07]	Tank type	0: EKHWS/E
N/A	[4-05]	Thermistor type	0: Automatic
[5.8]	[6-0E]	Maximum tank temperature	≤75°C

Emergency

When the heat pump fails to operate, the backup heater and/or booster heater can serve as an emergency heater. It then takes over the heat load either automatically or by manual interaction.

- When Emergency is set to Automatic and a heat pump failure occurs, the backup heater automatically takes over the heat load, and the booster heater in the optional tank takes over the domestic hot water production.
- When Emergency is set to Manual and a heat pump failure occurs, the domestic hot water heating and space heating stops.

To manually recover it via the user interface, go to the Malfunctioning main menu screen and confirm whether the backup heater and/or booster heater can take over the heat load or not.

- Alternatively, when Emergency is set to:
 - auto SH reduced/DHW on, space heating is reduced but domestic hot water is still available.
 - auto SH reduced/DHW off, space heating is reduced and domestic hot water is NOT available.
 - auto SH normal/DHW off, space heating operates as normally but domestic hot water is NOT available.

Similarly as in Manual mode, the unit can take the full load with the backup heater and/or booster heater if the user activates this via the Malfunctioning main menu screen.

To keep energy consumption low, we recommend to set Emergency to auto SH reduced/DHW off if the house is unattended for longer periods.

#	Code	Description
[9.5.1]	[4-06]	<ul style="list-style-type: none"> 0: Manual 1: Automatic 2: auto SH reduced/DHW on 3: auto SH reduced/DHW off 4: auto SH normal/DHW off

INFORMATION

The auto emergency setting can be set in the menu structure of the user interface only.

INFORMATION

If a heat pump failure occurs and Emergency is set to Manual, the following functions will remain active even if the user does NOT confirm emergency operation:

- Room frost protection
- Underfloor heating screed dryout
- Water pipe freeze prevention

However, the disinfection function will be activated ONLY if the user confirms emergency operation via the user interface.

Number of zones

The system can supply leaving water to up to 2 water temperature zones. During configuration, the number of water zones must be set.

INFORMATION

Mixing station. If your system layout contains 2 LWT zones, you need to install a mixing station in front of the main LWT zone.

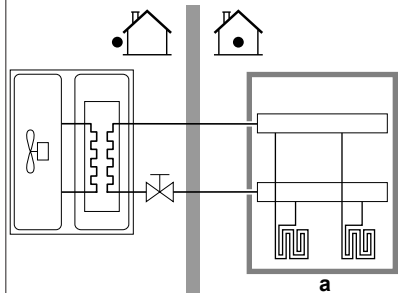
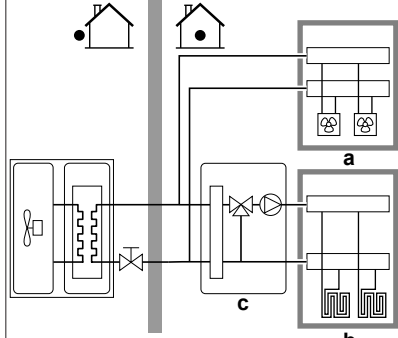
#	Code	Description
[4.4]	[7-02]	<ul style="list-style-type: none"> 0: Single zone <p>Only one leaving water temperature zone:</p>  <p>a Main LWT zone</p>
[4.4]	[7-02]	<ul style="list-style-type: none"> 1: Dual zone <p>Two leaving water temperature zones. The main leaving water temperature zone consists of the higher load heat emitters and a mixing station to achieve the desired leaving water temperature. In heating:</p>  <p>a Additional LWT zone: Highest temperature b Main LWT zone: Lowest temperature c Mixing station</p>

**NOTICE**

NOT configuring the system in the following way can cause damage to the heat emitters. If there are 2 zones, it is important that in heating:

- the zone with the lowest water temperature is configured as the main zone, and
- the zone with the highest water temperature is configured as the additional zone.

**NOTICE**

If there are 2 zones and the emitter types are wrongly configured, water of high temperature can be sent towards a low temperature emitter (underfloor heating). To avoid this:

- Install an aquastat/thermostatic valve to avoid too high temperatures towards a low temperature emitter.
- Make sure you set the emitter types for the main zone [2.7] and for the additional zone [3.7] correctly in accordance with the connected emitter.

**NOTICE**

A differential pressure bypass valve can be integrated in the system. Keep in mind that this valve might not be shown on the illustrations.

Glycol Filled system

This setting gives the installer the possibility to indicate whether the system is filled with glycol or water. This is important in case glycol is used to protect the water circuit against freezing. If NOT set correctly, the liquid in the piping can freeze.

#	Code	Description
N/A	[E-0D]	Glycol Filled system: Is the system filled with glycol? <ul style="list-style-type: none"> ▪ 0: No ▪ 1: Yes

**NOTICE**

If you add glycol to the water, you also need to install a flow switch (EKFLSW1).

Capacity / Booster heater capacity

The capacity of the booster heater must be set for the energy metering and/or power consumption control feature to work properly. When measuring the resistance value of the booster heater, you can set the exact heater capacity and this will lead to more accurate energy data.

#	Code	Description
[9.4.1]	[6-02]	Capacity / Booster heater capacity [kW]. Only applies to domestic hot water tank with an internal booster heater. The capacity of the booster heater at nominal voltage. Range: 0~10 kW

8.2.4 Configuration wizard: Backup heater**INFORMATION**

- For models with integrated backup heater (3V models), most of the backup heater settings are fixed.
- For other models, the backup heater settings are only applicable in case the optional external backup heater kit is installed.

The backup heater is adapted to be connected to most common European electricity grids. If the backup heater is available, the voltage, configuration and capacity must be set on the user interface.

The capacities for the different steps of the backup heater must be set for the energy metering and/or power consumption control feature to work properly. When measuring the resistance value of each heater, you can set the exact heater capacity and this will lead to more accurate energy data.

Backup heater type

- For models with integrated backup heater, this is fixed to 3V.
- For other models, this can be set to No heater, or External heater (i.e. when the optional external backup heater kit is installed).

#	Code	Description
[9.3.1]	[E-03]	<ul style="list-style-type: none"> ▪ 0: No heater ▪ 1: External heater ▪ 2: 3V

Voltage

- For a 3V model, this is fixed to 230V, 1ph.
- The optional external backup heater can be set to 230V, 1ph or 400V, 3ph.

#	Code	Description
[9.3.2]	[5-0D]	<ul style="list-style-type: none"> ▪ 0: 230V, 1ph ▪ 2: 400V, 3ph

Configuration

The backup heater can be configured in different ways. It can be chosen to have a 1-step only backup heater or a backup heater with 2 steps. If 2 steps, the capacity of the second step depends on this setting. It can also be chosen to have a higher capacity of the second step in emergency.

- For a 3V model, this is fixed to Relay 1.
- The optional external backup heater can be set to the following:

#	Code	Description
[9.3.3]	[4-0A]	<ul style="list-style-type: none"> ▪ 0: Relay 1 ▪ 1: Relay 1 / Relay 1+2 ▪ 2: Relay 1 / Relay 2 ▪ 3: Relay 1 / Relay 2 Emergency Relay 1+2

**INFORMATION**

Settings [9.3.3] and [9.3.5] are linked. Changing one setting influences the other. If you change one, check if the other is still as expected.

**INFORMATION**

During normal operation, the capacity of the second step of the backup heater at nominal voltage is equal to [6-03]+[6-04].

**INFORMATION**

If [4-0A]=3 and emergency mode is active, the power usage of the backup heater is maximal and equal to 2×[6-03]+[6-04].

Capacity step 1

#	Code	Description
[9.3.4]	[6-03]	<ul style="list-style-type: none"> ▪ The capacity of the first step of the backup heater at nominal voltage.

8 Configuration

Additional capacity step 2

Restriction: Only applicable in case the external backup heater kit is installed.

#	Code	Description
[9.3.5]	[6-04]	<ul style="list-style-type: none"> The capacity difference between the second and first step of the backup heater at nominal voltage. Nominal value depends on backup heater configuration.

8.2.5 Configuration wizard: Main zone

The most important settings for the main leaving water zone can be set here.

Emitter type

Heating up or cooling down the main zone can take longer. This depends on:

- The water volume of the system
- The heater emitter type of the main zone

The setting `Emitter type` can compensate for a slow or a quick heating/cooling system during the heat up/cool down cycle. In room thermostat control, `Emitter type` influences the maximum modulation of the desired leaving water temperature, and the possibility for usage of the automatic cooling/heating changeover based on the indoor ambient temperature.

It is important to set `Emitter type` correctly and in accordance with your system layout. The target delta T for the main zone depends on it.

#	Code	Description
[2.7]	[2-0C]	<ul style="list-style-type: none"> 0: Underfloor heating 1: Fancoil unit 2: Radiator

The setting of the emitter type has an influence on the space heating setpoint range and the target delta T in heating as follows:

Description	Space heating setpoint range	Target delta T in heating
0: Underfloor heating	Maximum 55°C	Variable
1: Fancoil unit	Maximum 55°C	Variable
2: Radiator	Maximum 60°C	Fixed 8°C

NOTICE

Average emitter temperature = Leaving water temperature – (Delta T)/2

This means that for a same leaving water temperature setpoint, the average emitter temperature of radiators is lower than that of underfloor heating because of a bigger delta T.

Example radiators: $40 - 8/2 = 36^{\circ}\text{C}$

Example underfloor heating: $40 - 5/2 = 37.5^{\circ}\text{C}$

To compensate, you can:

- Increase the weather-dependent curve desired temperatures [2.5].
- Enable leaving water temperature modulation and increase the maximum modulation [2.C].

Control

Define how the operation of the unit is controlled.

Control	In this control...
Leaving water	Unit operation is decided based on the leaving water temperature regardless the actual room temperature and/or heating or cooling demand of the room.
External room thermostat	Unit operation is decided by the external thermostat or equivalent (e.g. heat pump convector).
Room thermostat	Unit operation is decided based on the ambient temperature of the dedicated Human Comfort Interface (BRC1HHDA used as room thermostat).

#	Code	Description
[2.9]	[C-07]	<ul style="list-style-type: none"> 0: Leaving water 1: External room thermostat 2: Room thermostat

Setpoint mode

Define the setpoint mode:

- Fixed:** the desired leaving water temperature does not depend on the outdoor ambient temperature.
- In WD heating, fixed cooling mode,** the desired leaving water temperature:
 - depends on the outdoor ambient temperature for heating
 - does NOT depend on the outdoor ambient temperature for cooling
- In Weather dependent mode,** the desired leaving water temperature depends on the outdoor ambient temperature.

#	Code	Description
[2.4]	N/A	Setpoint mode: <ul style="list-style-type: none"> Fixed WD heating, fixed cooling Weather dependent

When weather dependent operation is active, low outdoor temperatures will result in warmer water and vice versa. During weather dependent operation, the user can shift the water temperature up or down by a maximum of 10°C.

Schedule

Indicates if the desired leaving water temperature is according to a schedule. Influence of the LWT setpoint mode [2.4] is as follows:

- In **Fixed LWT setpoint mode**, the scheduled actions consist of desired leaving water temperatures, either preset or custom.
- In **Weather dependent LWT setpoint mode**, the scheduled actions consist of desired shift actions, either preset or custom.

#	Code	Description
[2.1]	N/A	<ul style="list-style-type: none"> 0: No 1: Yes

8.2.6 Configuration wizard: Additional zone

The most important settings for the additional leaving water zone can be set here.

Emitter type

For more info about this functionality, see "[8.2.5 Configuration wizard: Main zone](#)" [p. 30].

#	Code	Description
[3.7]	[2-0D]	<ul style="list-style-type: none"> ▪ 0: Underfloor heating ▪ 1: Fancoil unit ▪ 2: Radiator

Control

The control type is displayed here, but cannot be adjusted. It is determined by the control type of the main zone. For more info about the functionality, see ["8.2.5 Configuration wizard: Main zone"](#) [▶ 30].

#	Code	Description
[3.9]	N/A	<ul style="list-style-type: none"> ▪ 0: Leaving water if the control type of the main zone is Leaving water. ▪ 1: External room thermostat if the control type of the main zone is External room thermostat or Room thermostat.

Setpoint mode

For more info about this functionality, see ["8.2.5 Configuration wizard: Main zone"](#) [▶ 30].

#	Code	Description
[3.4]	N/A	<ul style="list-style-type: none"> ▪ 0: Fixed ▪ 1: WD heating, fixed cooling ▪ 2: Weather dependent

If you choose WD heating, fixed cooling or Weather dependent, the next screen will be the detailed screen with weather-dependent curves. Also see ["8.3 Weather-dependent curve"](#) [▶ 32].

Schedule

Indicates if the desired leaving water temperature is according to a schedule. Also see ["8.2.5 Configuration wizard: Main zone"](#) [▶ 30].

#	Code	Description
[3.1]	N/A	<ul style="list-style-type: none"> ▪ 0: No ▪ 1: Yes

8.2.7 Configuration wizard: Tank

This part only applies to systems with an optional domestic hot water tank installed.

Heat up mode

The domestic hot water can be prepared in 3 different ways. They differ from each other by the way the desired tank temperature is set and how the unit acts upon it.

#	Code	Description
[5.6]	[6-0D]	Heat up mode: <ul style="list-style-type: none"> ▪ 0: Reheat only: Only reheat operation is allowed. ▪ 1: Schedule + reheat: The domestic hot water tank is heated according to a schedule and between the scheduled heat up cycles, reheat operation is allowed. ▪ 2: Schedule only: The domestic hot water tank can ONLY be heated according to a schedule.

See the operation manual for more details.



INFORMATION

Risk of space heating capacity shortage for domestic hot water tank without internal booster heater: In case of frequent domestic hot water operation, frequent and long space heating/cooling interruption will happen when selecting the following:

Tank > Heat up mode > Reheat only.

Settings for Reheat only mode

During Reheat only mode, the tank setpoint can be set on the user interface. The maximum allowed temperature is determined by the following setting:

#	Code	Description
[5.8]	[6-0E]	Maximum: The maximum temperature that users can select for the domestic hot water. You can use this setting to limit the temperature at the hot water taps. The maximum temperature is NOT applicable during disinfection function. See disinfection function.

To set the heat pump ON hysteresis:

#	Code	Description
[5.9]	[6-00]	Heat pump ON hysteresis <ul style="list-style-type: none"> ▪ 2°C~40°C

Settings for Schedule only mode and Schedule + reheat mode

Comfort setpoint

Only applicable when domestic hot water preparation is Schedule only or Schedule + reheat. When programming the schedule, you can make use of the comfort setpoint as a preset value. When you later want to change the storage setpoint, you only have to do it in one place.

The tank will heat up until the **storage comfort temperature** has been reached. It is the higher desired temperature when a storage comfort action is scheduled.

Additionally, a storage stop can be programmed. This feature puts a stop to tank heating even if the setpoint has NOT been reached. Only program a storage stop when tank heating is absolutely undesirable.

#	Code	Description
[5.2]	[6-0A]	Comfort setpoint: <ul style="list-style-type: none"> ▪ 30°C~[6-0E]°C

Eco setpoint

The **storage economic temperature** denotes the lower desired tank temperature. It is the desired temperature when a storage economic action is scheduled (preferably during day).

#	Code	Description
[5.3]	[6-0B]	Eco setpoint: <ul style="list-style-type: none"> ▪ 30°C~min(50,[6-0E])°C

Reheat setpoint

Desired reheat tank temperature, used:

- in Schedule + reheat mode, during reheat mode: the guaranteed minimum tank temperature is set by the Reheat setpoint minus the reheat hysteresis. If the tank temperature drops below this value, the tank is heated up.
- during storage comfort, to prioritize the domestic hot water preparation. When the tank temperature rises above this value, domestic hot water preparation and space heating/cooling are executed sequentially.

8 Configuration

#	Code	Description
[5.4]	[6-0C]	Reheat setpoint: ▪ 30°C~min(50,[6-0E])°C

Hysteresis (reheat hysteresis)

Applicable when domestic hot water preparation is scheduled+reheat. When the tank temperature drops below the reheat temperature minus the reheat hysteresis temperature, the tank heats up to the reheat temperature.

#	Code	Description
[5.A]	[6-08]	Reheat hysteresis ▪ 2°C~20°C

8.3 Weather-dependent curve

8.3.1 What is a weather-dependent curve?

Weather-dependent operation

The unit operates 'weather-dependent' if the desired leaving water or tank temperature is determined automatically by the outdoor temperature. It therefore is connected to a temperature sensor on the North wall of the building. If the outdoor temperature drops or rises, the unit compensates instantly. Thus, the unit does not have to wait for feedback by the thermostat to increase or decrease the temperature of the leaving water or tank. Because it reacts more quickly, it prevents high rises and drops of the indoor temperature and water temperature at tap points.

Advantage

Weather-dependent operation reduces energy consumption.

Weather-dependent curve

To be able to compensate for differences in temperature, the unit relies on its weather-dependent curve. This curve defines how much the temperature of the tank or leaving water must be at different outdoor temperatures. Because the slope of the curve depends on local circumstances such as climate and the insulation of the building, the curve can be adjusted by an installer or user.

Types of weather-dependent curve

There are 2 types of weather-dependent curves:

- 2-points curve
- Slope-offset curve

Which type of curve you use to make adjustments, depends on your personal preference. See "[8.3.4 Using weather-dependent curves](#)" [p 33].

Availability

The weather-dependent curve is available for:

- Main zone - Heating
- Main zone - Cooling
- Additional zone - Heating
- Additional zone - Cooling
- Tank (only available to installers)



INFORMATION

To operate weather-dependent, correctly configure the setpoint of the main zone, additional zone or tank. See "[8.3.4 Using weather-dependent curves](#)" [p 33].

8.3.2 2-points curve

Define the weather-dependent curve with these two setpoints:

- Setpoint (X1, Y2)

- Setpoint (X2, Y1)

Example

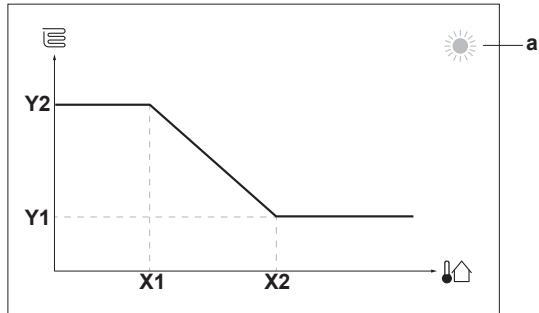

Item	Description
a	Selected weather-dependent zone: ▪ ☀: Main zone or additional zone heating ▪ ❄: Main zone or additional zone cooling ▪ 🚿: Domestic hot water
X1, X2	Examples of outdoor ambient temperature
Y1, Y2	Examples of desired tank temperature or leaving water temperature. The icon corresponds to the heat emitter for that zone: ▪ 🏠: Underfloor heating ▪ 🌀: Fan coil unit ▪ 📺: Radiator ▪ 🚿: Domestic hot water tank

Possible actions on this screen

ⓘ⋯⋯○	Go through the temperatures.
○⋯⋯ⓘ	Change the temperature.
○⋯⋯🏠	Go to the next temperature.
🏠⋯⋯○	Confirm changes and proceed.

8.3.3 Slope-offset curve

Slope and offset

Define the weather-dependent curve by its slope and offset:

- Change the **slope** to differently increase or decrease the temperature of the leaving water for different ambient temperatures. For example, if leaving water temperature is in general fine but at low ambient temperatures too cold, raise the slope so that leaving water temperature is heated increasingly more at decreasingly lower ambient temperatures.
- Change the **offset** to equally increase or decrease the temperature of the leaving water for different ambient temperatures. For example, if leaving water temperature is always a bit too cold at different ambient temperatures, shift the offset up to equally increase the leaving water temperature for all ambient temperatures.

Examples

Weather-dependent curve when slope is selected:

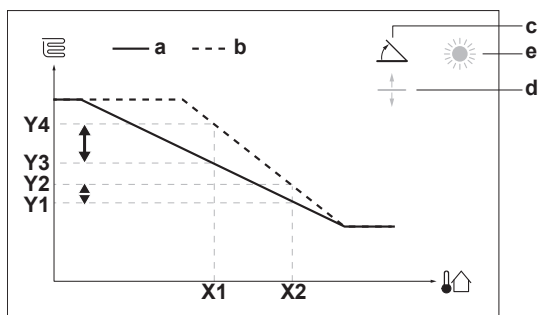

Weather-dependent curve when offset is selected:

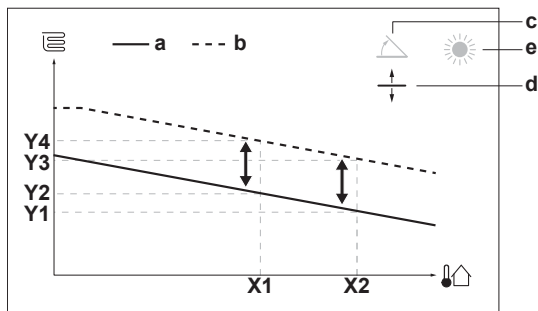

Item	Description
a	WD curve before changes.
b	WD curve after changes (as example): <ul style="list-style-type: none"> When slope is changed, the new preferred temperature at X1 is unequally higher than the preferred temperature at X2. When offset is changed, the new preferred temperature at X1 is equally higher as the preferred temperature at X2.
c	Slope
d	Offset
e	Selected weather-dependent zone: <ul style="list-style-type: none"> : Main zone or additional zone heating : Main zone or additional zone cooling : Domestic hot water
X1, X2	Examples of outdoor ambient temperature
Y1, Y2, Y3, Y4	Examples of desired tank temperature or leaving water temperature. The icon corresponds to the heat emitter for that zone: <ul style="list-style-type: none"> : Underfloor heating : Fan coil unit : Radiator : Domestic hot water tank

Possible actions on this screen	
	Select slope or offset.
	Increase or decrease the slope/offset.
	When slope is selected: set slope and go to offset. When offset is selected: set offset.
	Confirm changes and return to the submenu.

8.3.4 Using weather-dependent curves

Configure weather-dependent curves as following:

To define the setpoint mode

To use the weather-dependent curve, you need to define the correct setpoint mode:

Go to setpoint mode ...	Set the setpoint mode to ...
Main zone – Heating	
[2.4] Main zone > Setpoint mode	WD heating, fixed cooling OR weather dependent
Main zone – Cooling	
[2.4] Main zone > Setpoint mode	Weather dependent
Additional zone – Heating	
[3.4] Additional zone > Setpoint mode	WD heating, fixed cooling OR weather dependent
Additional zone – Cooling	
[3.4] Additional zone > Setpoint mode	Weather dependent
Tank	
[5.B] Tank > Setpoint mode	Restriction: Only available to installers. Weather dependent

To change the type of weather-dependent curve

To change the type for all zones (main + additional) and for the tank, go to [2.E] Main zone > WD curve type.

Viewing which type is selected is also possible via:

- [3.C] Additional zone > WD curve type
- [5.E] Tank > WD curve type

Restriction: Only available to installers.

To change the weather-dependent curve

Zone	Go to ...
Main zone – Heating	[2.5] Main zone > Heating WD curve
Main zone – Cooling	[2.6] Main zone > Cooling WD curve
Additional zone – Heating	[3.5] Additional zone > Heating WD curve
Additional zone – Cooling	[3.6] Additional zone > Cooling WD curve
Tank	Restriction: Only available to installers. [5.C] Tank > WD curve



INFORMATION

Maximum and minimum setpoints

You cannot configure the curve with temperatures that are higher or lower than the set maximum and minimum setpoints for that zone or for the tank. When the maximum or minimum setpoint is reached, the curve flattens out.

To fine-tune the weather-dependent curve: slope-offset curve

The following table describes how to fine-tune the weather-dependent curve of a zone or tank:

You feel ...		Fine-tune with slope and offset:	
At regular outdoor temperatures ...	At cold outdoor temperatures ...	Slope	Offset
OK	Cold	↑	—
OK	Hot	↓	—
Cold	OK	↓	↑
Cold	Cold	—	↑

8 Configuration

You feel ...		Fine-tune with slope and offset:	
At regular outdoor temperatures ...	At cold outdoor temperatures ...	Slope	Offset
Cold	Hot	↓	↑
Hot	OK	↑	↓
Hot	Cold	↑	↓
Hot	Hot	—	↓

To fine-tune the weather-dependent curve: 2-points curve

The following table describes how to fine-tune the weather-dependent curve of a zone or tank:

You feel ...		Fine-tune with setpoints:			
At regular outdoor temperatures ...	At cold outdoor temperatures ...	Y2 ^(a)	Y1 ^(a)	X1 ^(a)	X2 ^(a)
OK	Cold	↑	—	↑	—
OK	Hot	↓	—	↓	—
Cold	OK	—	↑	—	↑
Cold	Cold	↑	↑	↑	↑
Cold	Hot	↓	↑	↓	↑
Hot	OK	—	↓	—	↓
Hot	Cold	↑	↓	↑	↓
Hot	Hot	↓	↓	↓	↓

^(a) See "8.3.2 2-points curve" ▶ 32].

8.4 Settings menu

You can set additional settings using the main menu screen and its submenus. The most important settings are presented here.

8.4.1 Main zone

Ext thermostat type

Only applicable in external room thermostat control.



NOTICE

If an external room thermostat is used, the external room thermostat will control the room frost protection. However, the room frost protection is only possible if [C.2] Space heating/cooling=On.

#	Code	Description
[2.A]	[C-05]	External room thermostat type for the main zone: <ul style="list-style-type: none"> 1: 1 contact: The used external room thermostat can only send a thermo ON/OFF condition. There is no separation between heating or cooling demand. 2: 2 contacts: The used external room thermostat can send a separate heating/cooling thermo ON/OFF condition.

8.4.2 Additional zone

Ext thermostat type

Only applicable in external room thermostat control. For more info about the functionality, see "8.4.1 Main zone" ▶ 34].

#	Code	Description
[3.A]	[C-06]	External room thermostat type for the additional zone: <ul style="list-style-type: none"> 1: 1 contact 2: 2 contacts

8.4.3 Information

Dealer information

The installer can fill in his contact number here.

#	Code	Description
[8.3]	N/A	Number that users can call in case of problems.

8.5 Menu structure: Overview installer settings

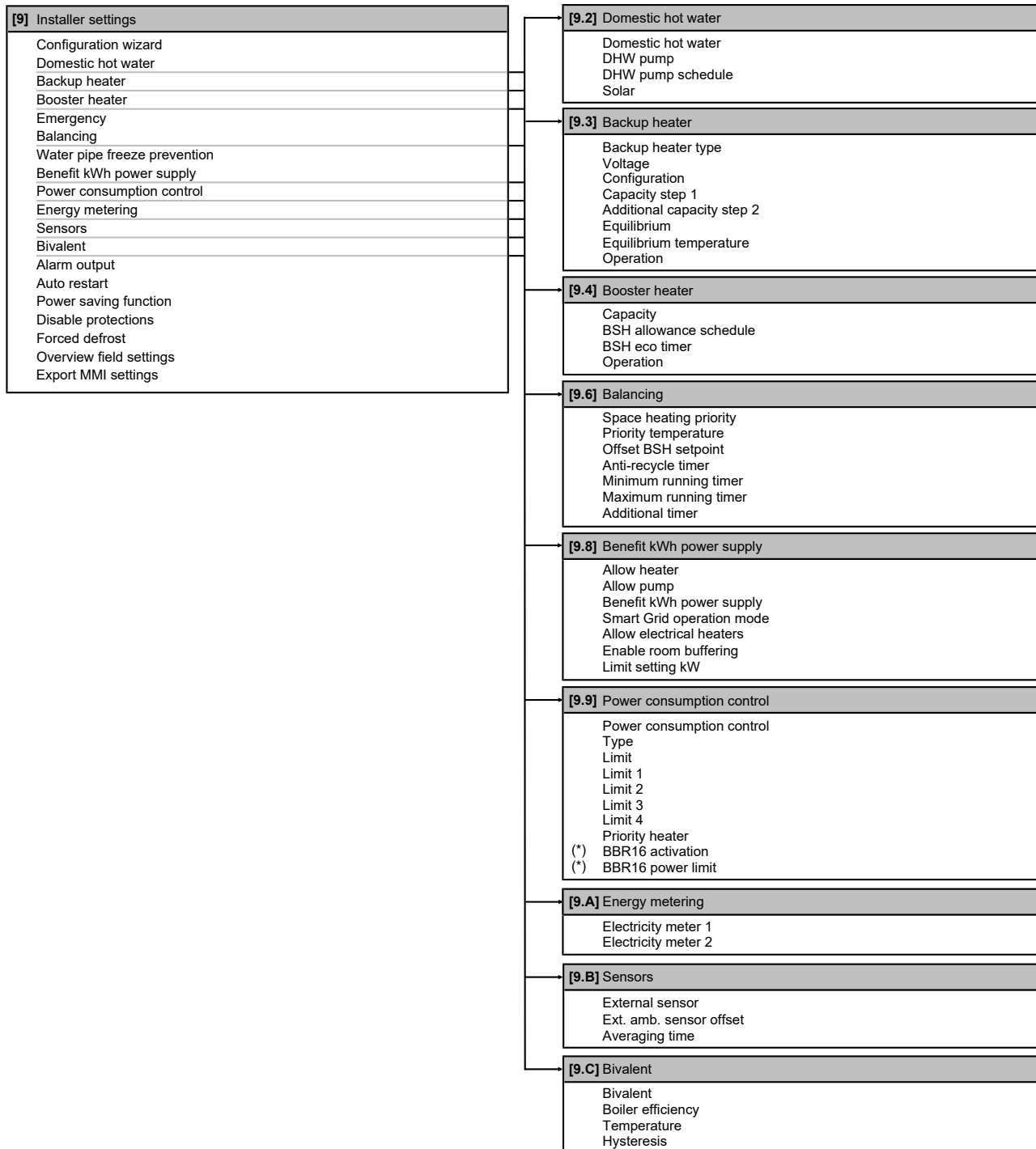

(*) Only applicable in Swedish language.



INFORMATION

Depending on the selected installer settings and unit type, settings will be visible/invisible.

9 Commissioning

9 Commissioning

NOTICE

General commissioning checklist. Next to the commissioning instructions in this chapter, a general commissioning checklist is also available on the Daikin Business Portal (authentication required).

The general commissioning checklist is complementary to the instructions in this chapter and can be used as a guideline and reporting template during commissioning and hand-over to the user.

NOTICE

ALWAYS operate the unit with thermistors and/or pressure sensors/switches. If NOT, burning of the compressor might be the result.

NOTICE

For models with integrated backup heater: The unit contains an automatic air purge valve on the backup heater. Make sure it is open. All automatic air purge valves in the system (in the unit, and in the field piping –if any) must remain open after commissioning.



For other models: The unit contains a manual air purge valve. Make sure it is closed. Only open it when performing an air purge.



INFORMATION

Protective functions – "Installer-on-site mode". The software is equipped with protective functions, such as room antifrost. The unit automatically runs these functions when necessary.

During installation or service this behaviour is undesired. Therefore, the protective functions can be disabled:

- **At first power-on:** The protective functions are disabled by default. After 12 hours they will be automatically enabled.
- **Afterwards:** An installer can manually disable the protective functions by setting [9.G]: Disable protections=Yes. After his work is done, he can enable the protective functions by setting [9.G]: Disable protections=No.

9.1 Checklist before commissioning

- 1 After the installation of the unit, check the items listed below.
- 2 Close the unit.
- 3 Power up the unit.

<input type="checkbox"/>	You read the complete installation instructions, as described in the installer reference guide .
<input type="checkbox"/>	The outdoor unit is properly mounted.
<input type="checkbox"/>	The outdoor unit's transportation stay is removed.

<input type="checkbox"/>	Field wiring Check that the field wiring has been carried out according to the instructions described in the chapter " 6 Electrical installation " [▶ 12], according to the wiring diagrams and according to the applicable national wiring regulation.
<input type="checkbox"/>	The system is properly earthed and the earth terminals are tightened.
<input type="checkbox"/>	The fuses or locally installed protection devices are installed according to this document, and have NOT been bypassed.
<input type="checkbox"/>	The power supply voltage matches the voltage on the identification label of the unit.
<input type="checkbox"/>	There are NO loose connections or damaged electrical components in the switch box.
<input type="checkbox"/>	There are NO damaged components or squeezed pipes on the inside of the outdoor unit.
<input type="checkbox"/>	Only for models with integrated backup heater (F1B: field supply), or if the external backup heater kit (F1B: factory-mounted in the backup heater kit) is installed: Backup heater circuit breaker F1B is turned ON.
<input type="checkbox"/>	Only for tanks with built-in booster heater: Booster heater circuit breaker F2B (field supply) is turned ON.
<input type="checkbox"/>	The correct pipe size is installed and the pipes are properly insulated.
<input type="checkbox"/>	There are no water leaks inside the outdoor unit.
<input type="checkbox"/>	The shut-off valves are properly installed and fully open.
<input type="checkbox"/>	For models with integrated backup heater: The automatic air purge valve (on the backup heater) is open. For other models: The manual air purge valve is closed.
<input type="checkbox"/>	The pressure relief valve (space heating circuit) purges water when opened. Clean water MUST come out.
<input type="checkbox"/>	The minimum water volume is guaranteed in all conditions. See "To check the water volume and flow rate" in " 5.1 Preparing water piping " [▶ 8].
<input type="checkbox"/>	(if applicable) The domestic hot water tank is filled completely.

9.2 Checklist during commissioning

<input type="checkbox"/>	The minimum flow rate is guaranteed in all conditions. See "To check the water volume and flow rate" in " 5.1 Preparing water piping " [▶ 8].
<input type="checkbox"/>	To perform an air purge .
<input type="checkbox"/>	To perform a test run .
<input type="checkbox"/>	To perform an actuator test run .
<input type="checkbox"/>	Underfloor screed dryout function The underfloor screed dryout function is started (if necessary).

9.2.1 To check the minimum flow rate

1	Check the hydraulic configuration to find out which space heating loops can be closed by mechanical, electronic, or other valves.	—
2	Close all space heating loops that can be closed.	—
3	Start the pump test run (see " 9.2.4 To perform an actuator test run " [▶ 37]).	—

4	Read out the flow rate ^(a) and modify the bypass valve setting to reach the minimum required flow rate + 2 l/min.	—
---	--	---

^(a) During pump test run, the unit can operate below the minimum required flow rate.

If operation is...	Then the minimum required flow rate is...
Cooling	20 l/min
Heating/defrost when outdoor temperature is above -5°C	
Heating/defrost when outdoor temperature is below -5°C	22 l/min
Domestic hot water production	28 l/min

9.2.2 To perform an air purge

Conditions: Make sure all operation is disabled. Go to [C]: Operation and turn off Space heating/cooling and Tank operation.

1	Set the user permission level to Installer. See " To change the user permission level " [▶ 26].	—
2	Go to [A.3]: Commissioning > Air purge.	
3	Select OK to confirm. Result: The air purge starts. It stops automatically when air purge cycle is finished.	
To stop the air purge manually:		—
1	Go to Stop air purge.	
2	Select OK to confirm.	

9.2.3 To perform an operation test run

Conditions: Make sure all operation is disabled. Go to [C]: Operation and turn off Space heating/cooling and Tank operation.

1	Set the user permission level to Installer. See " To change the user permission level " [▶ 26].	—
2	Go to [A.1]: Commissioning > Operation test run.	
3	Select a test from the list. Example: Heating.	
4	Select OK to confirm. Result: The test run starts. It stops automatically when ready (±30 min).	
To stop the test run manually:		—
1	In the menu, go to Stop test run.	
2	Select OK to confirm.	



INFORMATION

If the outdoor temperature is outside the range of operation, the unit may NOT operate or may NOT deliver the required capacity.

To monitor leaving water and tank temperatures

During test run, the correct operation of the unit can be checked by monitoring its leaving water temperature (heating/cooling mode) and tank temperature (domestic hot water mode).

To monitor the temperatures:

1	In the menu, go to Sensors.	
2	Select the temperature information.	

9.2.4 To perform an actuator test run

Purpose

Perform an actuator test run to confirm the operation of the different actuators. For example, when you select Pump, a test run of the pump will start.

Conditions: Make sure all operation is disabled. Go to [C]: Operation and turn off Space heating/cooling and Tank operation.

1	Set the user permission level to Installer. See " To change the user permission level " [▶ 26].	—
2	Go to [A.2]: Commissioning > Actuator test run.	
3	Select a test from the list. Example: Pump.	
4	Select OK to confirm. Result: The actuator test run starts. It stops automatically when ready (±30 min).	
To stop the test run manually:		—
1	In the menu, go to Stop test run.	
2	Select OK to confirm.	

Possible actuator test runs

- Booster heater test
- Backup heater 1 test
- Backup heater 2 test
- Pump test



INFORMATION

Make sure that all air is purged before executing the test run. Also avoid disturbances in the water circuit during the test run.

- Diverter valve test (3-way valve for switching between space heating and tank heating)
- Bivalent signal test
- Alarm output test
- C/H signal test
- DHW pump test

9.2.5 To perform an underfloor heating screed dryout

Conditions: Make sure all operation is disabled. Go to [C]: Operation and turn off Space heating/cooling and Tank operation.

1	Set the user permission level to Installer. See " To change the user permission level " [▶ 26].	—
2	Go to [A.4]: Commissioning > UFH screed dryout.	
3	Set a dryout program: go to Program and use the UFH screed dryout programming screen.	
4	Select OK to confirm. Result: The underfloor heating screed dryout starts. It stops automatically when done.	
To stop the test run manually:		—
1	Go to Stop UFH screed dryout.	
2	Select OK to confirm.	

10 Hand-over to the user



NOTICE

To perform an underfloor heating screed dryout, room frost protection needs to be disabled ([2-06]=0). By default, it is enabled ([2-06]=1). However, due to the "installer-on-site" mode (see "Commissioning"), room frost protection will be automatically disabled for 12 hours after the first power-on.

If the screed dryout still needs to be performed after the first 12 hours of power-on, manually disable room frost protection by setting [2-06] to "0", and KEEP it disabled until the screed dryout has finished. Ignoring this notice will result in cracking of the screed.



NOTICE

For the underfloor heating screed dryout to be able to start, make sure the following settings are met:

- [4-00]=1
 - [C-02]=0
 - [D-01]=0
 - [4-08]=0
 - [4-01]≠1
-

10 Hand-over to the user

Once the test run is finished and the unit operates properly, make sure the following is clear for the user:

- Fill in the installer setting table (in the operation manual) with the actual settings.
- Make sure that the user has the printed documentation and ask him/her to keep it for future reference. Inform the user that he can find the complete documentation at the URL mentioned earlier in this manual.
- Explain the user how to properly operate the system and what to do in case of problems.
- Show the user what to do for the maintenance of the unit.
- Explain about energy saving tips to the user as described in the operation manual.

11 Technical data

A subset of the latest technical data is available on the regional Daikin website (publicly accessible). The full set of the latest technical data is available on the Daikin Business Portal (authentication required).

11.1 Piping diagram: Outdoor unit

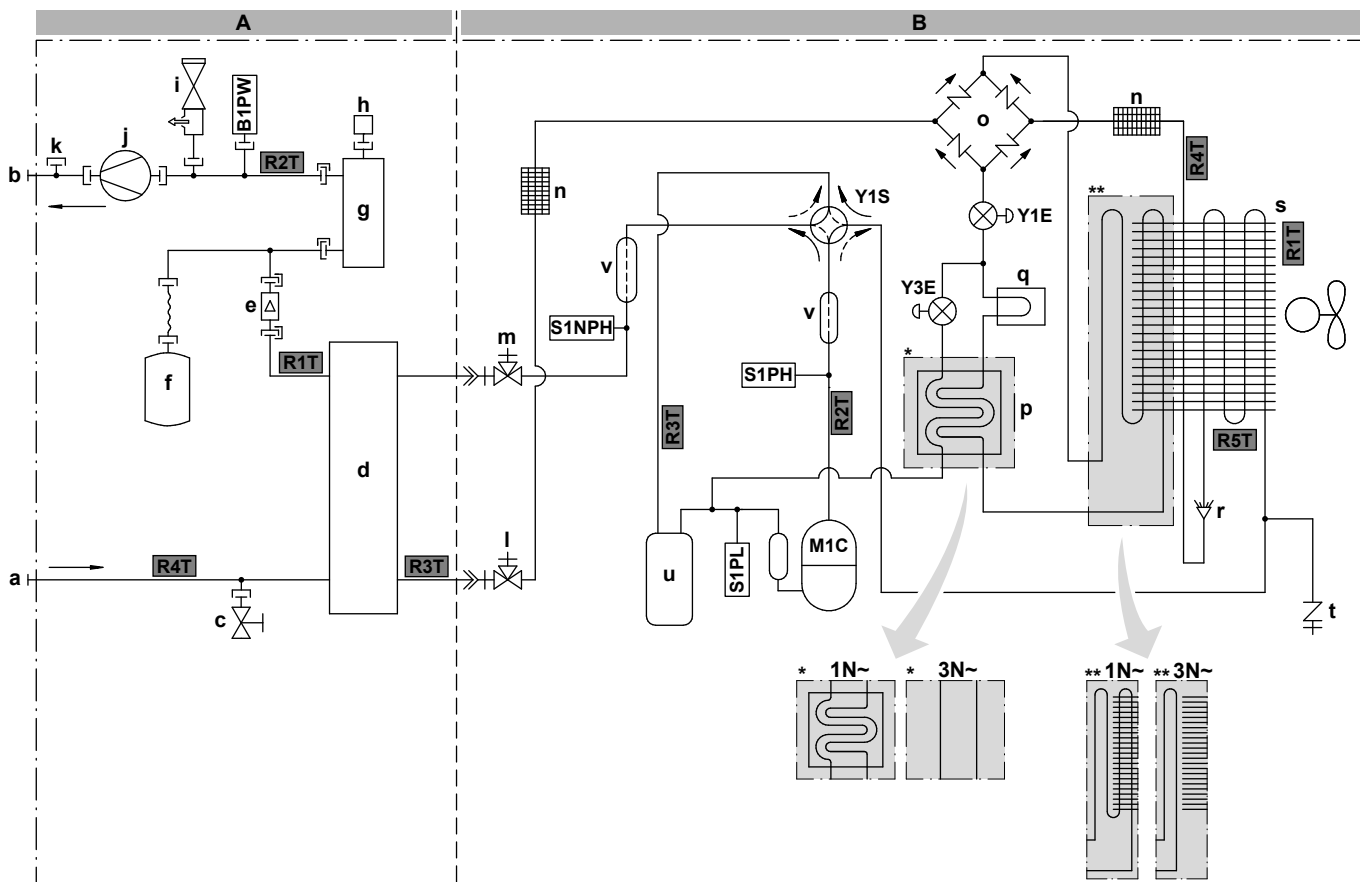

3D128953A

A Hydro module

B Compressor module

- a Water IN (screw connection, male, 1")
- b Water OUT (screw connection, male, 1")
- c Drain valve (water circuit)
- d Plate heat exchanger
- e Flow sensor
- f Expansion vessel
- g Backup heater
- h Automatic air purge valve
- i Safety valve
- j Pump
- k Connection for optional flow switch
- l Liquid stop valve with service port
- m Gas stop valve with service port
- n Filter
- o Rectifier
- p Economiser
- q Heat sink
- r Distributor
- s Heat exchanger
- t Service port 5/16" flare
- u Accumulator
- v Muffler

- B1PW** Space heating water pressure sensor
- M1C** Compressor
- S1PH** High pressure switch
- S1PL** Low pressure switch
- S1NPH** Pressure sensor
- Y1E** Electronic expansion valve (main)
- Y3E** Electronic expansion valve (injection)
- Y1S** Solenoid valve (4-way valve)

Thermistors (hydro module):

- R1T** Outlet water heat exchanger
 - R2T** Outlet water backup heater
 - R3T** Refrigerant liquid side
 - R4T** Inlet water
- Thermistors (compressor module):**
- R1T** Outdoor air
 - R2T** Compressor discharge
 - R3T** Compressor suction
 - R4T** Air heat exchanger
 - R5T** Air heat exchanger, middle

Refrigerant flow:

- ➔ Heating
- ➔ Cooling

Connections:

- ⊥ Screw connection
- ⋈ Flare connection
- ⊥ Quick coupling
- Brazed connection

11 Technical data

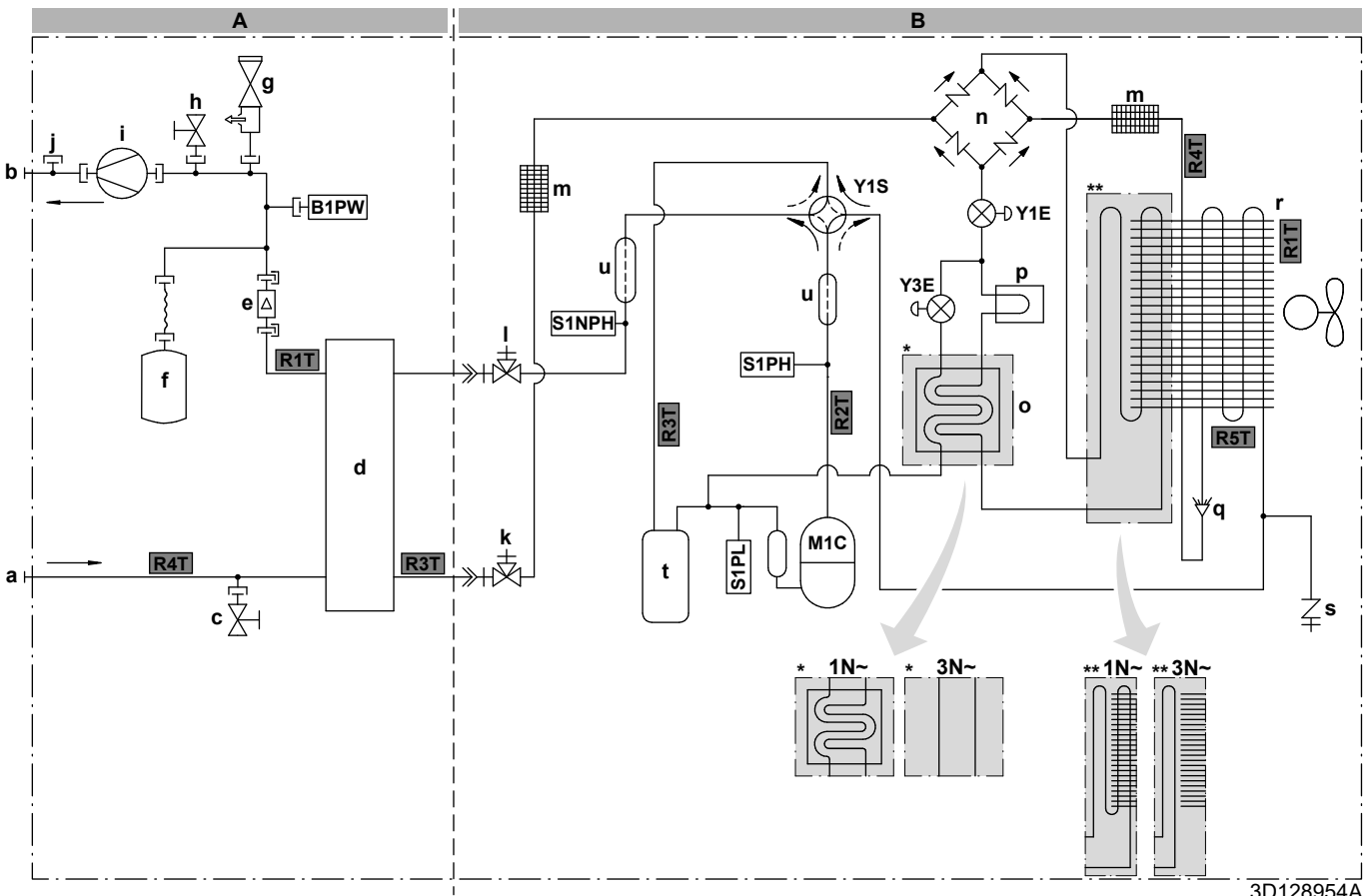

3D128954A

A Hydro module
B Compressor module

- a Water IN (screw connection, male, 1")
- b Water OUT (screw connection, male, 1")
- c Drain valve (water circuit)
- d Plate heat exchanger
- e Flow sensor
- f Expansion vessel
- g Safety valve
- h Manual air purge valve
- i Pump
- j Connection for optional flow switch
- k Liquid stop valve with service port
- l Gas stop valve with service port
- m Filter
- n Rectifier
- o Economiser
- p Heat sink
- q Distributor
- r Heat exchanger
- s Service port 5/16" flare
- t Accumulator
- u Muffler

- B1PW** Space heating water pressure sensor
- M1C** Compressor
- S1PH** High pressure switch
- S1PL** Low pressure switch
- S1NPH** Pressure sensor
- Y1E** Electronic expansion valve (main)
- Y3E** Electronic expansion valve (injection)
- Y1S** Solenoid valve (4-way valve)

Thermistors (hydro module):

- R1T** Outlet water heat exchanger
- R3T** Refrigerant liquid side
- R4T** Inlet water

Thermistors (compressor module):

- R1T** Outdoor air
- R2T** Compressor discharge
- R3T** Compressor suction
- R4T** Air heat exchanger
- R5T** Air heat exchanger, middle

Refrigerant flow:

- Heating
- ⇄ Cooling

Connections:

- ⊥ Screw connection
- ⋈ Flare connection
- ⊥ Quick coupling
- Brazed connection

11.2 Wiring diagram: Outdoor unit

The wiring diagram is delivered with the unit, located at the inside of the service cover.

Compressor module



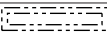
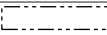
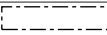
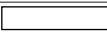

Translation of text on wiring diagram:

English	Translation
(1) Connection diagram	(1) Connection diagram
Compressor SWB	Compressor switch box
Outdoor	Outdoor
(2) Compressor switch box layout	(2) Compressor switch box layout
Front	Front
Rear	Rear
(3) Legend	(3) Legend
	*: Optional; #: Field supply
A1P	Printed circuit board (main)
A2P	Printed circuit board (noise filter)
A3P	Printed circuit board (flash)
(only for 1N~ models)	
Q1DI	# Earth leakage circuit breaker
X1M	Terminal strip
(4) Notes	(4) Notes
X1M	Main terminal
-----	Earth wiring
-----	Field supply
①	Several wiring possibilities
	Option
	Wiring depending on model
	Switch box
	PCB

Hydro module

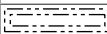
Translation of text on wiring diagram:

English	Translation
(1) Connection diagram	(1) Connection diagram
2-point SPST valve	2-point SPST valve
Booster heater power supply	Booster heater power supply
Compressor switch box	Compressor switch box
External BUH	External backup heater kit
For DHW tank option	For DHW tank option
For external BUH option	For external backup heater kit
For normal power supply (standard)	For normal power supply (standard)
For preferential kWh rate power supply (outdoor)	For preferential kWh rate power supply (outdoor)
Hydro SWB power supplied from compressor SWB	Hydro switch box power supplied from compressor switch box
Hydro	Hydro module
Normal kWh rate power supply	Normal kWh rate power supply
Outdoor	Outdoor
SWB1	Hydro switch box 1 (front side)
SWB2	Hydro switch box 2 (right side)
Use normal kWh rate power supply for hydro SWB	Use normal kWh rate power supply for hydro switch box
(2) Hydro SWB layout	(2) Hydro switch box layout
For external BUH option	For external backup heater kit

English	Translation
For internal BUH option	For models with integrated backup heater
SWB1	Hydro switch box 1 (front side)
SWB2	Hydro switch box 2 (right side)
SWB3	Hydro switch box 3 (behind SWB2)
(3) Notes	(3) Notes
X1M	Terminal (main)
X2M	Terminal (field wiring for AC)
X3M	Terminal (external backup heater kit)
X4M	Terminal (booster heater power supply)
X5M	Terminal (field wiring for DC)
X9M	Terminal (integrated backup heater power supply)
X10M	Terminal (high voltage Smart Grid)
-----	Earth wiring
-----	Field supply
①	Several wiring possibilities
	Option
	Wiring depending on model
	Switch box
	PCB
(4) Legend	(4) Legend
	*: Optional; #: Field supply
A1P	Main PCB
A2P	* ON/OFF thermostat (PC=power circuit)
A3P	* Heat pump convector
A4P	* Digital I/O PCB
A8P	* Demand PCB
A11P	MMI (= standalone user interface delivered as accessory) – Main PCB
A14P	* PCB of the dedicated Human Comfort Interface (BRC1HHDA used as room thermostat)
A15P	* Receiver PCB (wireless ON/OFF thermostat)
CN* (A4P)	* Connector
DS1 (A8P)	* DIP switch
E*P (A9P)	Indication LED
F1B	# Overcurrent fuse backup heater
F2B	# Overcurrent fuse booster heater
F1U, F2U (A4P)	Fuse 5 A 250 V for digital I/O PCB
K1A, K2A	* High voltage Smart Grid relay
K1M	Safety contactor backup heater
K3M	* Contactor booster heater
K*R (A4P)	Relay on PCB
M2P	# Domestic hot water pump
M2S	# 2-way valve for cooling mode

11 Technical data

English	Translation
M3S	* 3-way valve for floorheating / domestic hot water
M4S	* Bypass valve kit (for external backup heater kit)
PC (A15P)	* Power circuit
PHC1 (A4P)	* Optocoupler input circuit
Q2L	* Thermal protector booster heater
Q4L	# Safety thermostat
Q*DI	# Earth leakage circuit breaker
R1H (A2P)	* Humidity sensor
R1T (A2P)	* Ambient sensor of the ON/OFF thermostat
R1T (A14P)	* Ambient sensor of the dedicated Human Comfort Interface (BRC1HHDA used as room thermostat)
R2T (A2P)	* External sensor (floor or ambient)
R5T	* Domestic hot water thermistor
R6T	* External indoor or outdoor ambient thermistor
S1L	* Flow switch
S1S	# Preferential kWh rate power supply contact
S2S	# Electricity meter pulse input 1
S3S	# Electricity meter pulse input 2
S4S	# Smart Grid feed-in
S6S~S9S	* Digital power limitation inputs
S10S, S11S	# Low voltage Smart Grid contact
SS1 (A4P)	* Selector switch
TR1	Power supply transformer
X4M	* Terminal strip (booster heater power supply)
X8M	# Terminal strip (power supply at client side)
X9M	Terminal strip (integrated backup heater power supply)
X10M	* Terminal strip (Smart Grid power supply)
X*, X*A, X*Y	Connector
X*M	Terminal strip
Z*C	Noise filter (ferrite core)
(5) Option PCBs	(5) Option PCBs
230 V AC Control Device	230 V AC control device
Alarm output	Alarm output
Changeover to ext. heat source	Changeover to external heat source
For demand PCB option	For demand PCB option
For digital I/O PCB option	For digital I/O PCB option
Max. load	Maximum load
Min. load	Minimum load
Options: ext. heat source output, alarm output	Options: external heat source output, alarm output
Options: On/OFF output	Options: ON/OFF output
Power limitation digital inputs: 12 V DC / 12 mA detection (voltage supplied by PCB)	Power limitation digital inputs: 12 V DC / 12 mA detection (voltage supplied by PCB)
Space C/H On/OFF output	Space cooling/heating ON/OFF output

English	Translation
SWB 1	Hydro switch box 1 (front side)
(6) Options	(6) Options
Continuous	Continuous current
DHW pump output	Domestic hot water pump output
Electric pulse meter input: 12 V DC pulse detection (voltage supplied by PCB)	Electricity meter pulse input: 12 V DC pulse detection (voltage supplied by PCB)
Ext. ambient sensor option (indoor or outdoor)	External indoor or outdoor ambient thermistor
For ***	For ***
For cooling mode	For cooling mode
For HP tariff	For preferential kWh rate power supply
For HV smartgrid	For high voltage Smart Grid
For LV smartgrid	For low voltage Smart Grid
For safety thermostat	For safety thermostat
For smartgrid	For Smart Grid
Inrush	Inrush current
Max. load	Maximum load
MMI	Standalone user interface (delivered as accessory)
NO valve	Normal open valve
Preferential kWh rate power supply contact: 16 V DC detection (voltage supplied by PCB)	Preferential kWh rate power supply contact: 16 V DC detection (voltage supplied by PCB)
Remote user interface	Dedicated Human Comfort Interface (BRC1HHDA used as room thermostat)
Safety thermostat contact: 16 V DC detection (voltage supplied by PCB)	Safety thermostat contact: 16 V DC detection (voltage supplied by PCB)
SD card	Card slot for WLAN cartridge
Smartgrid contacts	Smart Grid contacts
Smartgrid PV power pulse meter	Smart Grid photovoltaic power pulse meter
SWB1	Hydro switch box 1 (front side)
SWB2	Hydro switch box 2 (right side)
WLAN cartridge	WLAN cartridge
(7) External On/OFF thermostats and heat pump convector	(7) External ON/OFF thermostats and heat pump convector
Additional LWT zone	Additional leaving water temperature zone
For external sensor (floor/ ambient)	For external sensor (floor or ambient)
For heat pump convector	For heat pump convector
For wired On/OFF thermostat	For wired ON/OFF thermostat
For wireless On/OFF thermostat	For wireless ON/OFF thermostat
Main LWT zone	Main leaving water temperature zone

Hydro module — Integrated backup heater

Translation of text on wiring diagram:

English	Translation
(1) Connection diagram	(1) Connection diagram
For internal BUH option	For models with integrated backup heater
Hydro	Hydro module
Outdoor	Outdoor

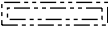
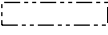
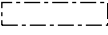
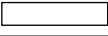
English	Translation
SWB2	Hydro switch box 2 (right side)
(2) Notes	(2) Notes
X1M	Terminal (main)
X2M	Terminal (field wiring for AC)
X4M	Terminal (booster heater power supply)
X5M	Terminal (field wiring for DC)
X9M	Terminal (integrated backup heater power supply)
X10M	Terminal (Smart Grid)
-----	Earth wiring
-----	Field supply
①	Several wiring possibilities
	Option
	Wiring depending on model
	Switch box
	PCB
(3) BUH switch box	(3) Backup heater switch box
SWB1	Hydro switch box 1 (front side)
SWB2	Hydro switch box 2 (right side)
SWB3	Hydro switch box 3 (behind SWB2)
(4) Legend	(4) Legend
	*: Optional; #: Field supply
A1P	Main PCB
A4P	* Digital I/O PCB
A8P	* Demand PCB
F1B	# Overcurrent fuse backup heater
K1A, K2A	* High voltage Smart Grid relay
K1M	Safety contactor backup heater
K3M	* Contactor booster heater
Q1DI	# Earth leakage circuit breaker
TR1	Power supply transformer
X4M	* Terminal strip (booster heater power supply)
X6M	# Terminal strip (power supply at client side)
X9M	Terminal strip (integrated backup heater power supply)
X10M	* Terminal (high voltage Smart Grid)
X*A	Connector
X*M	Terminal strip

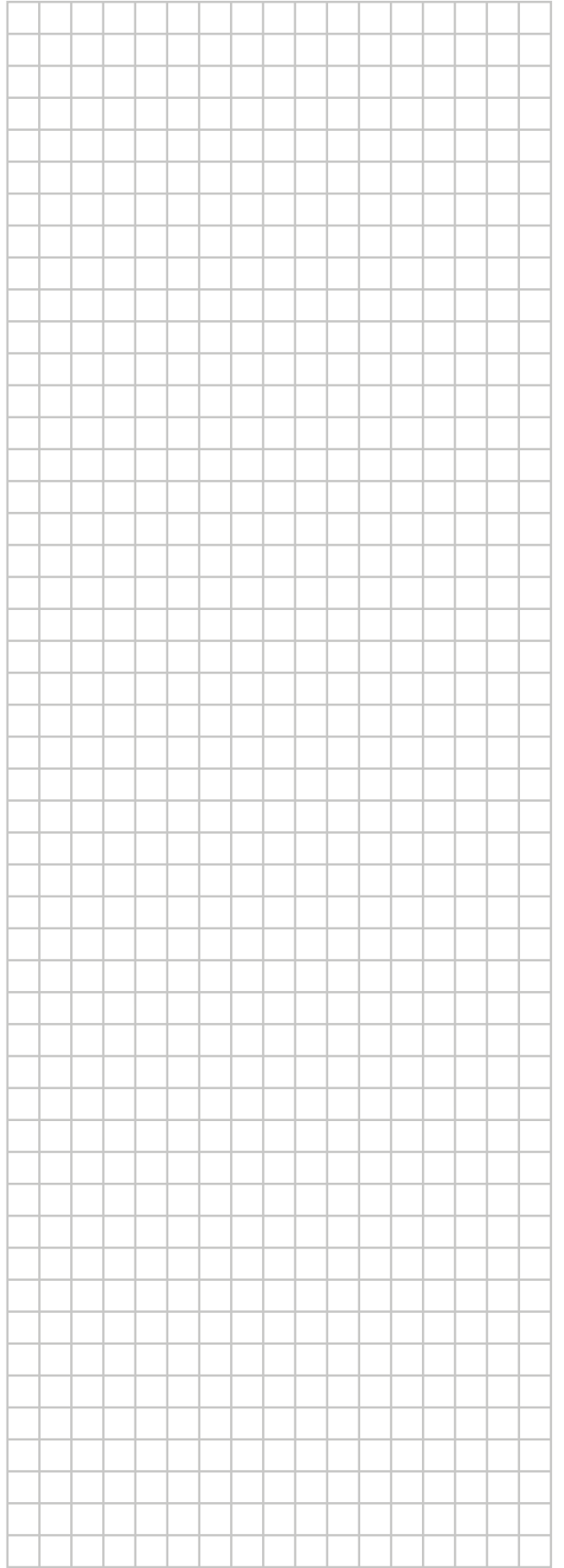
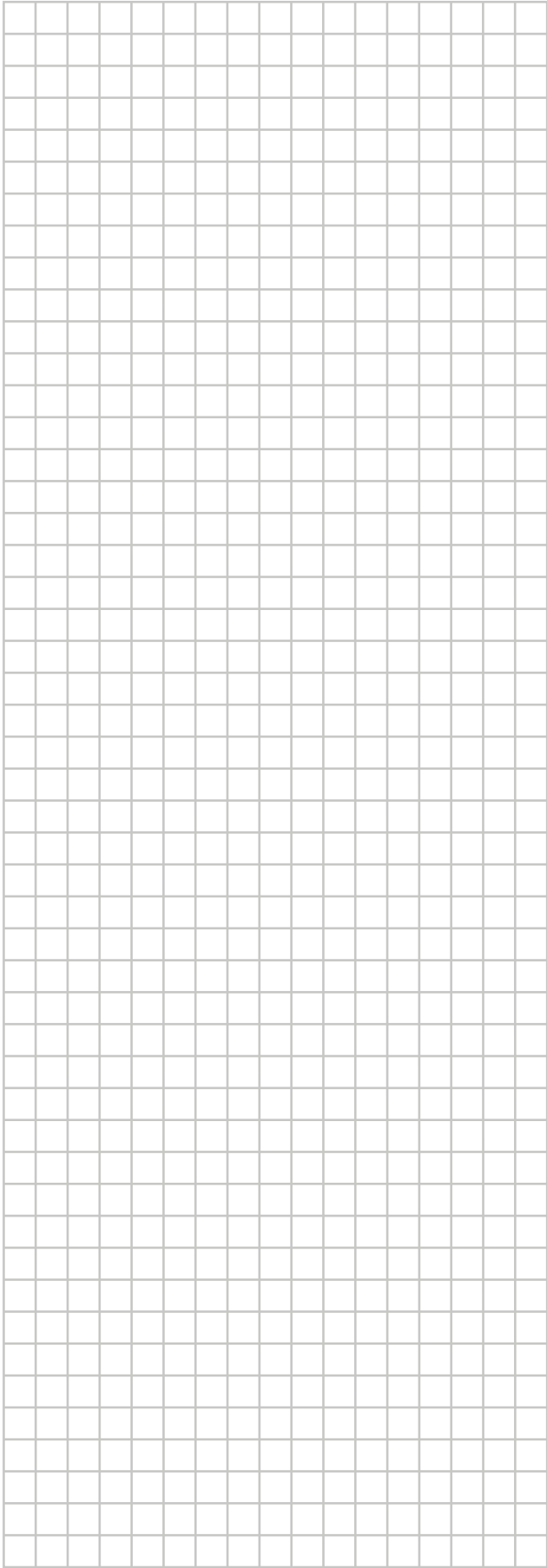

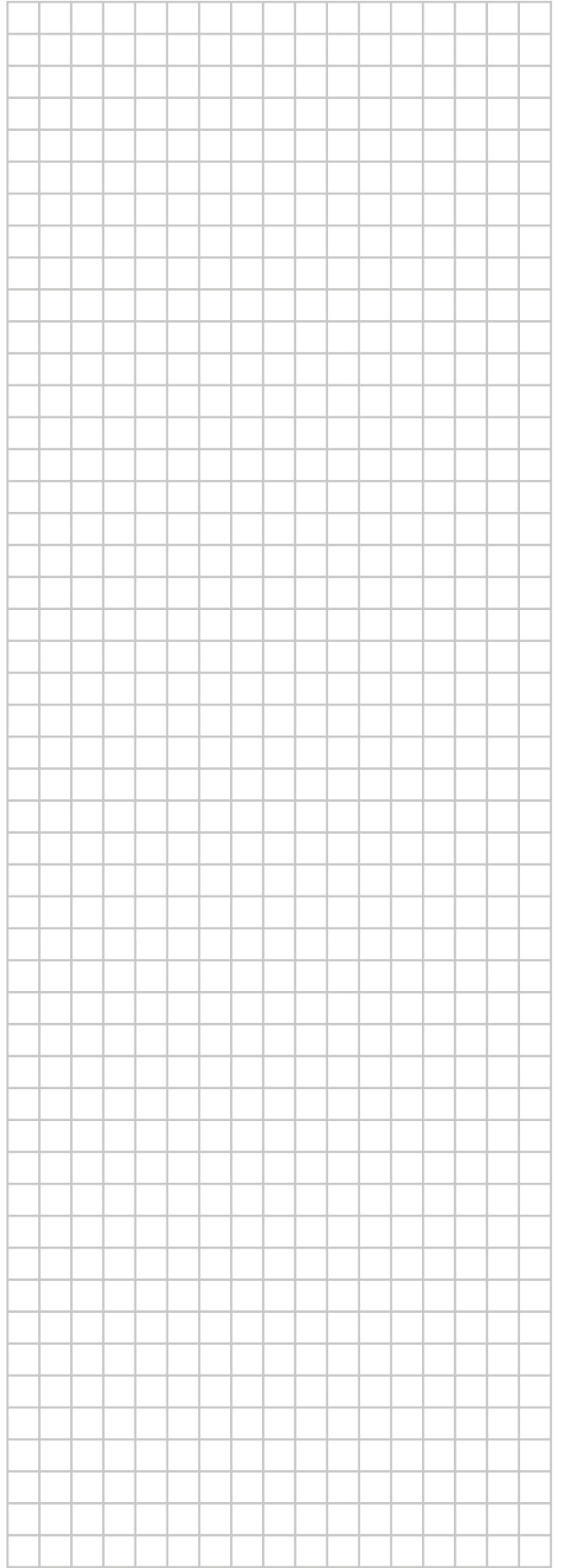
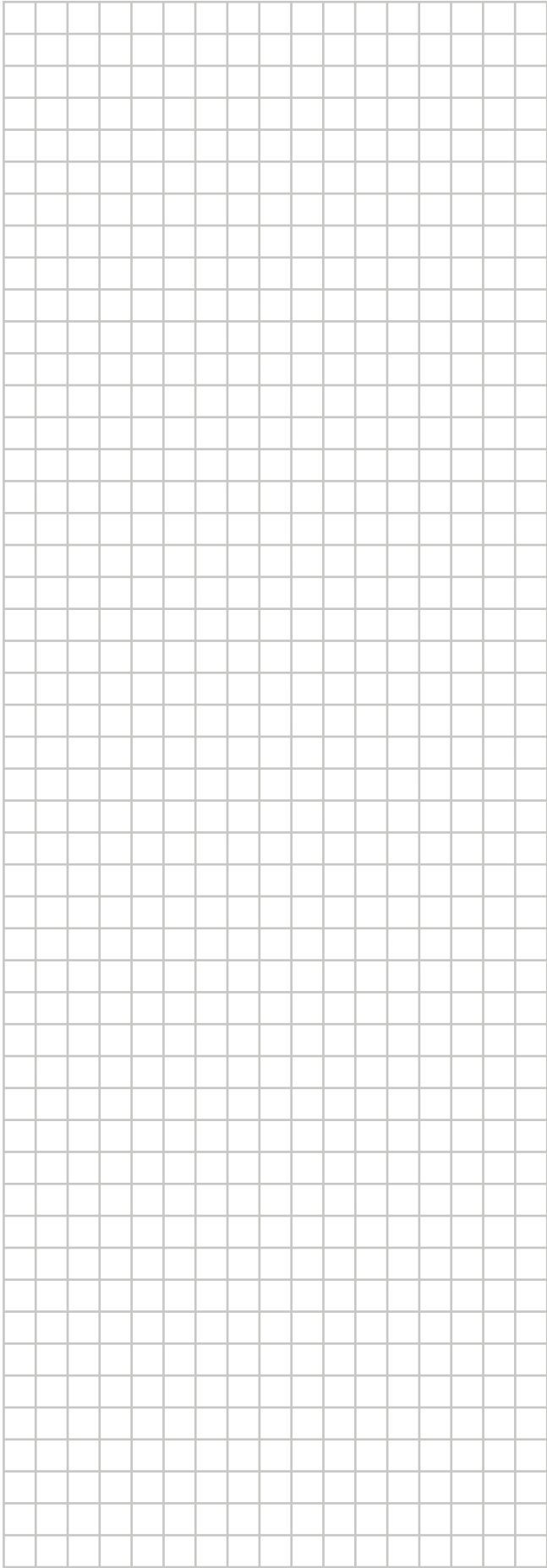

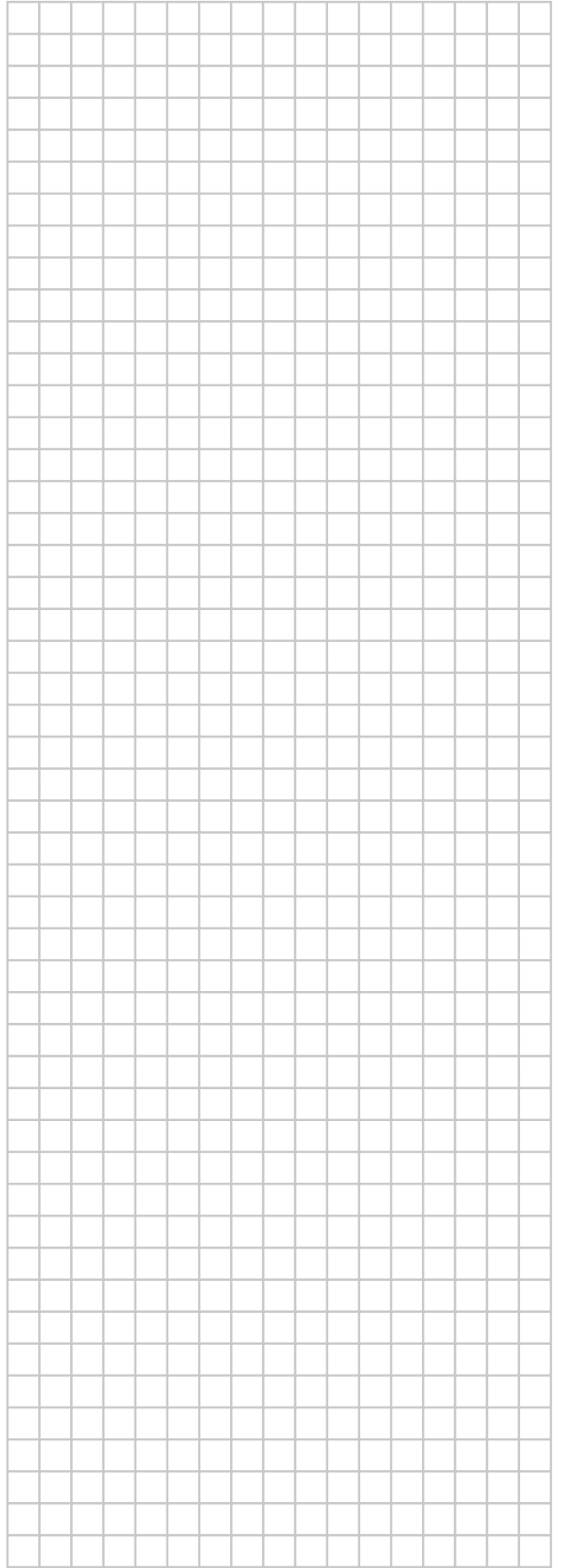
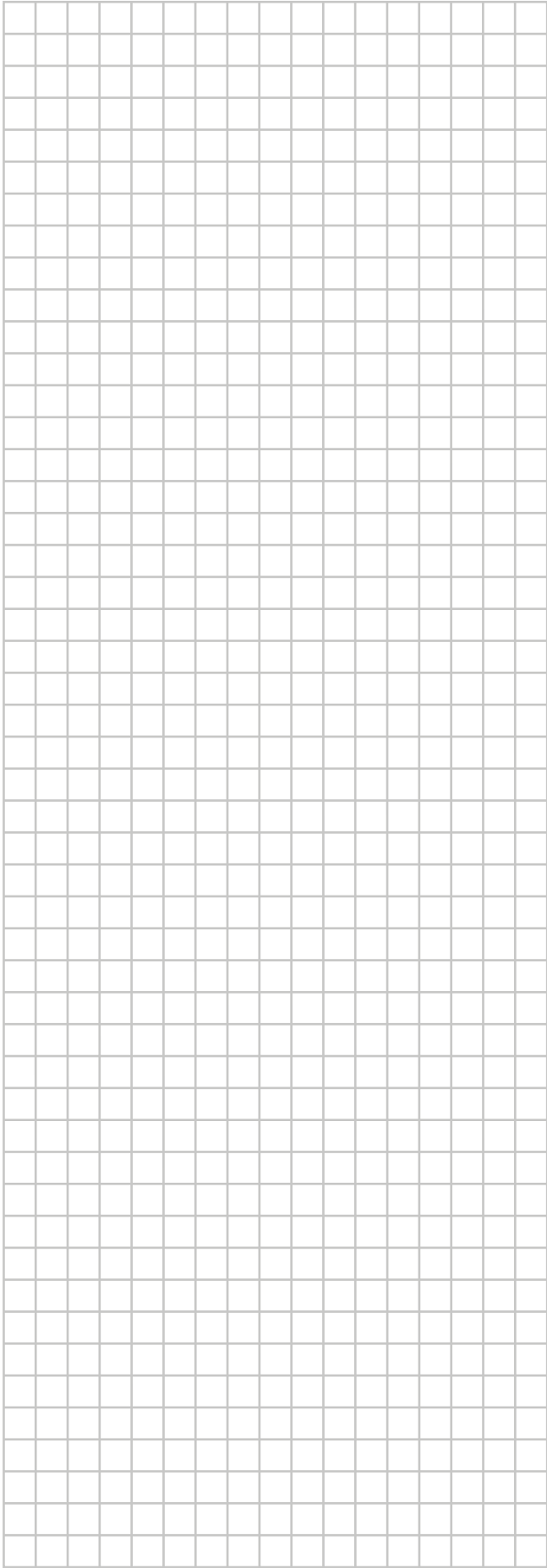



4P765229-1 0000000T

Copyright 2024 Daikin

DAIKIN EUROPE N.V.

Zandvoordestraat 300, B-8400 Oostende, Belgium

4P765229-1 2024.01