

---

## **Wireless Remote Controller Kit**

---

### MODELS

**BRC7EA628**  
**BRC7EA629**  
**BRC7EA630**

---



## CONTENTS

SAFETY PRECAUTIONS..... 1

BEFORE INSTALLATION .....2

REMOTE CONTROLLER INSTALLATION ..... 2

RECEIVER INSTALLATION..... 3

FIELD SETTING..... 8

TEST OPERATION ..... 9

Read these instructions carefully before installation. Keep this manual in a handy place for future reference. The English text is the original instruction. Other languages are translations of the original instructions.

### 1. SAFETY PRECAUTIONS

Please read these "SAFETY PRECAUTIONS" carefully before installing air conditioning equipment and be sure to install it correctly. After completing the installation, make sure at start up operation that the unit operates properly. Please instruct the customer how to operate the unit and keep maintenance.

Meaning of caution symbols



**CAUTION** ..... If the caution is not observed, it may cause injury or damage to equipment.

**NOTE**  ..... These instructions will ensure proper use of the equipment.









#### CAUTION





- Refer also to the installation manual attached to the indoor unit.
- Confirm that following conditions are satisfied prior to installation.
  - Ensure that nothing interrupts the operation of the wireless remote controller. (Ensure that there is neither a source of light nor fluorescent lamp near the receiver. Also, ensure that the receiver is not exposed to direct sun light.)
  - Ensure that the operation display lamp and other indicators are easy to see.



## 2. BEFORE INSTALLATION

### 2-1 ACCESSORIES

Check if the following accessories are included with your option kit.

Name	Receiver		(3) Relay harness - long	(4) Relay harness - short	Wireless remote controller	Screw
	(1) Light receiver assembly	(2) Transmission PC-board				
Quantity	1 pc.	1 pc.	1 pc.	1 pc.	1 pc.	2 pcs.
Shape						

Name	Remote controller holder	(5) Unit No. nameplate	(6) Control panel (with label)	Dry cell battery LR03 (AM4)	(7) Clamp									
Quantity	1 pc.	1 pc.	1 pc.	2 pcs.	1 pc.									
Shape		<table border="1" data-bbox="370 568 449 624"> <tr><td>1</td><td>2</td><td>3</td></tr> <tr><td>1</td><td>2</td><td>3</td></tr> <tr><td>1</td><td>2</td><td>3</td></tr> </table>	1	2	3	1	2	3	1	2	3			
1	2	3												
1	2	3												
1	2	3												

Name	Sealing material (8)	Operation manual	Installation manual
Quantity	1pc.	1 pc.	1 pc.
Shape			

### 2-2 NOTE TO THE INSTALLER

- Be sure to instruct the customer how to properly operate the system showing him/her the attached operation manual.

## 3. REMOTE CONTROLLER INSTALLATION

### ⟨Installing wireless remote controller⟩

- Do not throw the remote controller or impose large shocks. Also, do not store where it may be exposed to moisture or direct sunlight.
- When operating, point the transmitting part of the remote controller in the direction of the receiver.
- The direct transmitting distance of the remote controller is approximately 7 meters.
- The signal cannot be transmitted if something (e.g. curtains) blocks the receiver and the remote controller.

• **Installing to a wall or a pillar**

1. Fix the remote controller holder with the screws.

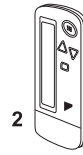

2. Slide the remote controller into the remote controller holder from the top.

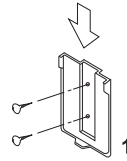

• **How to insert the batteries**

1. Open the back cover of the remote controller by sliding it in the direction of the arrow.

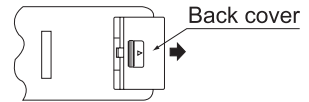

2. Insert the attached dry cell batteries. Properly insert, set the batteries by matching the (+) and (-) polarity marks as indicated. Then close the back cover as before.

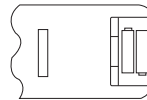

## 4. RECEIVER INSTALLATION

### (1) Preparations before installation

Remove the service cover and the front grill. See the installation manual that came with the main indoor unit for details on removal.

### (2) Determination of address and MAIN/SUB remote controller.

If setting multiple wireless remote controllers to operate in one room, perform address setting for the receiver and the wireless remote controller.

If setting multiple wired remote controllers in one room, change the MAIN/SUB switch of the receiver.

## SETTING PROCEDURE

### 1. Setting the receiver

Set the wireless address switch (SS2) on the transmission PC-board (2) according to the table below.

Unit No.	No. 1	No. 2	No. 3
Wireless address switch (SS2)	1 2 3 [Diagram: switch knob at position 1]	1 2 3 [Diagram: switch knob at position 2]	1 2 3 [Diagram: switch knob at position 3]

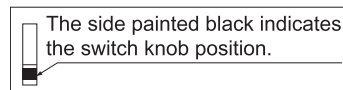



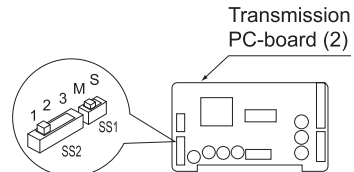

When using both a wired and a wireless remote controller for 1 indoor unit, the wired controller should be set to MAIN. Therefore, set the MAIN/SUB switch (SS1) of the receiver to SUB.  
(The wired remote controller will be "MAIN".)

	MAIN	SUB
MAIN/SUB switch (SS1)	M S [Diagram: switch knob at position M]	M S [Diagram: switch knob at position S]





## 2. Setting the address of wireless remote controller (It is factory set to "1")

(Setting from the remote controller)

1. Hold down the  button and the  button for at least 4 seconds to get the Field Set mode. (Indicated in the display area in the figure at right.)
2. Press the  button and select a multiple setting (A/b). Each time the button is pressed the display switches between "A" and "b".
3. Press the " " button and " " button to set the address.

→ 1 → 2 → 3 → 4 → 5 → 6

Address can be set from 1 to 6, but set it to 1 ~ 3 and to same address as the receiver. (The receiver does not work with address 4 ~ 6.)

4. Press the  button to enter the setting.
5. Hold down the  button for at least 1 second to quit the Field Set mode and return to the normal display.

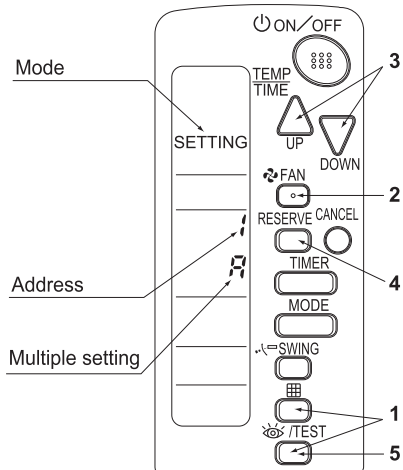

### Multiple settings A/b

When the indoor unit is being operated by outside control (central remote controller, etc.), it sometimes does not respond to ON/OFF and temperature setting commands from this remote controller. Check what setting the customer wants and make the multiple setting as shown below.

Remote controller		Movement when the operation is controlled by the other air conditioners and equipment
Multiple setting	Remote controller display	
A: Standard	All items displayed.	When operation changeover, temperature setting or the like is carried out from the remote controller, the indoor unit rejects the instruction. (Signal receiving sound "peeh" or "pick-pick-pick") As a result, a discrepancy between the operation state of the indoor unit and the indication of the remote controller display occurs.
b: Multi System	Operations remain displayed shortly after execution.	All commands accepted. (Signal receiving sound "pick-pick") Since the indication of the remote controller is turned off, no discrepancy such as mentioned above occurs.

3. Attach the included unit number nameplate (5) to the front grill on the indoor unit and the back of the wireless remote controller.

#### [PRECAUTIONS]

Set the unit number of the receiver and the wireless remote controller to be equal. If the setting differs, the signal from the remote controller cannot be transmitted.

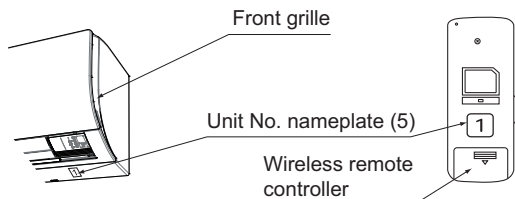

**(3) Attaching the receiver**

1. Connect the included relay harness – long (3) and relay harness – short (4) to the connector on the transmission PC-board (2).

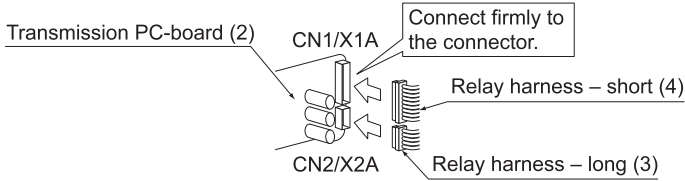

2. Following the figure, insert transmission PC-board (2) into tab 1, then insert into tab 2 while pushing tab 1 in the direction of the arrow.

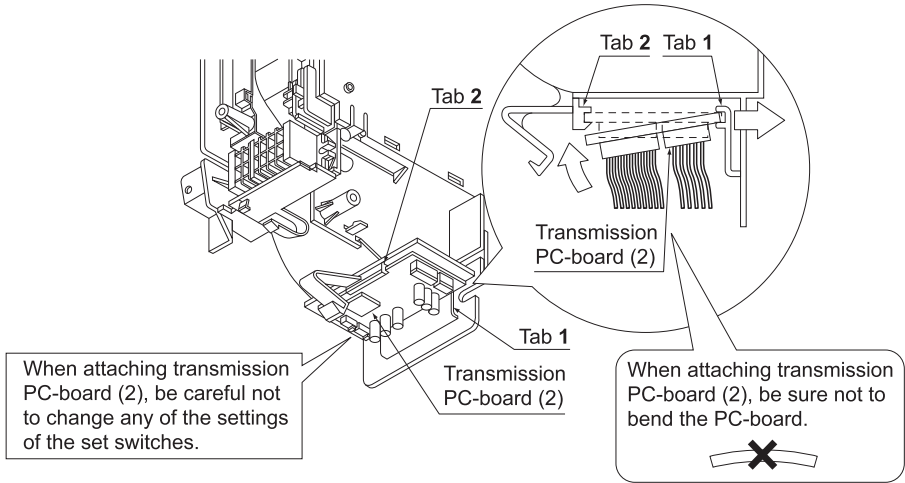

3. Attach the included light receiver assembly (1) to the 2 tabs on the indoor unit, according to following figure.

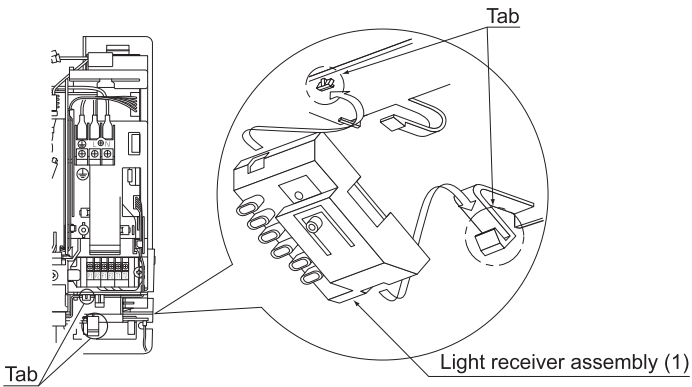

4. Connect the relay harnesses which were connected to the transmission PC-board (2) in step 1. as follows.
- Relay harness – long (3) to connector X24A on the indoor unit PC-board
  - Relay harness – short (4) to connector CN1/X1A on the light receiver assembly (1)
- After making these connection, clamp down relay harness – long (3) and relay harness – short (4) using the included clamp (7).

**BRC7EA628/29**

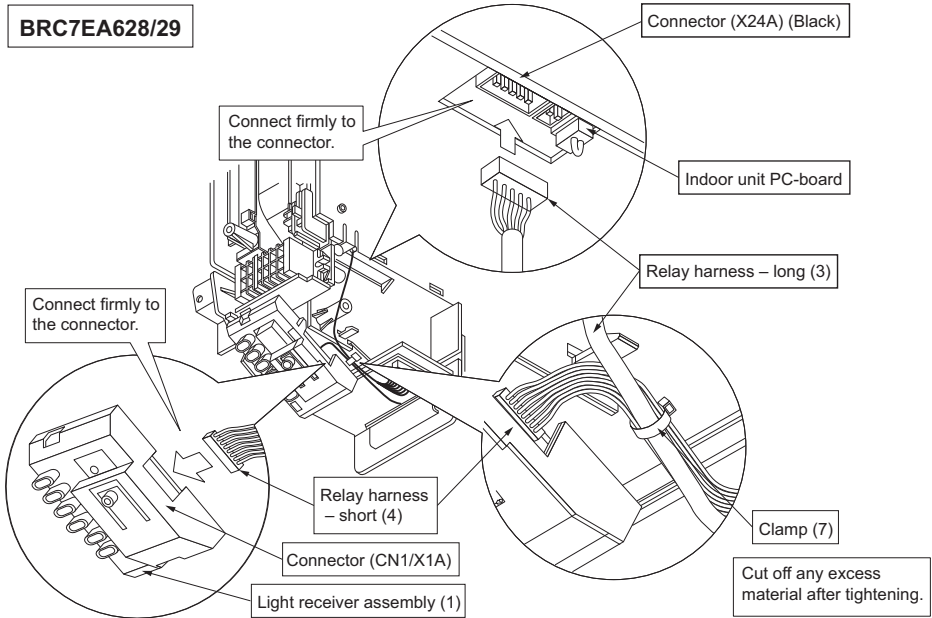

**BRC7EA630**

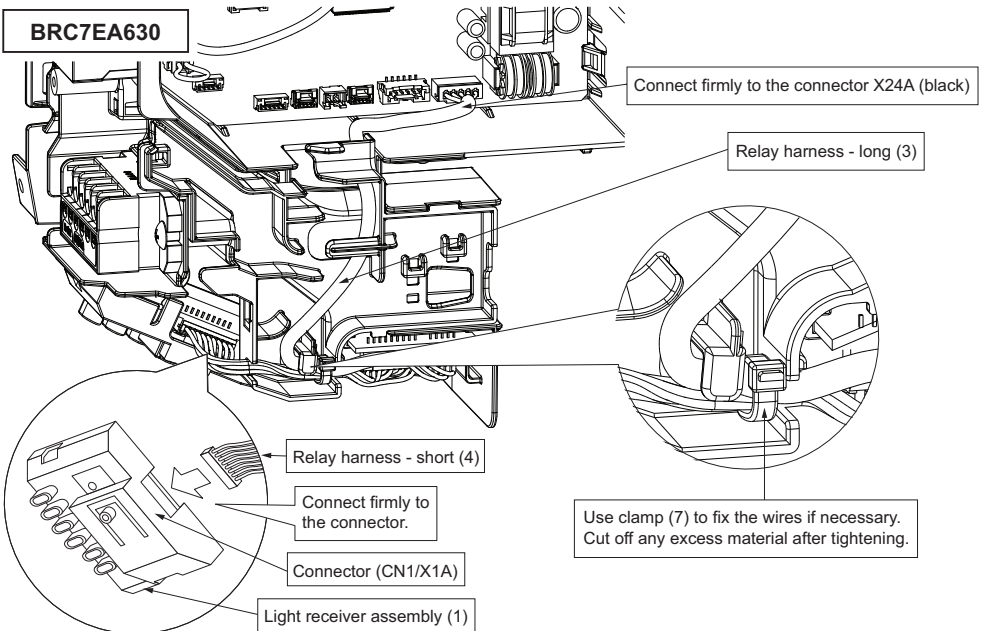

**(4) Attaching the control panel**

1. Remove the sealing material and prepare new replacement sealing material (accessory).

**Inside view of the front grill**

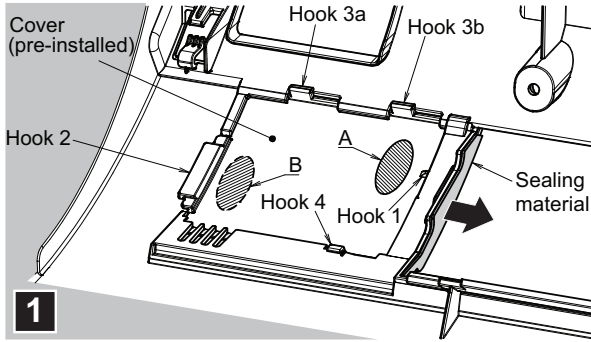

**NOTE**

- The hook positions are the same for both pre-installed cover and control panel.

2. Slide the cover to side while pushing the cover on A position from the back side and on B position from the front side. Hooks 1 and 2 will be removed from their positions.
3. Take the cover away by pulling the left side of the cover away from the front grill, removing hooks 3a, 3b and 4 from their position.

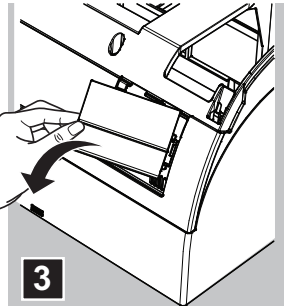
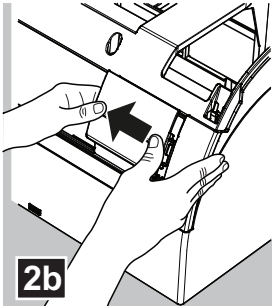
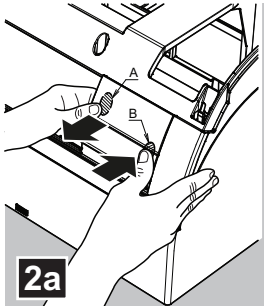

4. Position the hook 4 on the control panel to the correct location on the front grill.
5. Attach the hooks 3a and 3b by pushing them against the front grill.

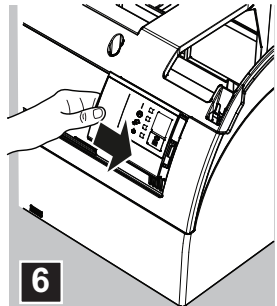
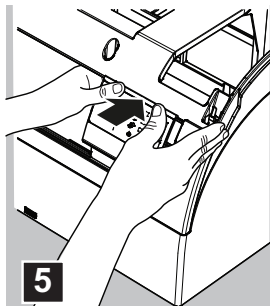
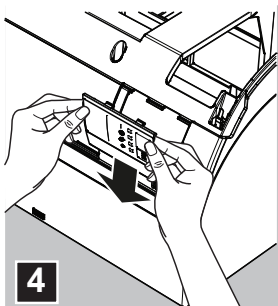

6. Slide the control panel as indicated to attach hooks 1 and 2 to their correct position.



- The control panel should be placed in the front grill as in the following figure.
- Attach new sealing material in the original position (accessory (8)).

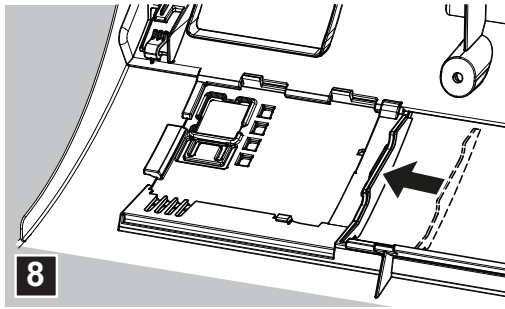
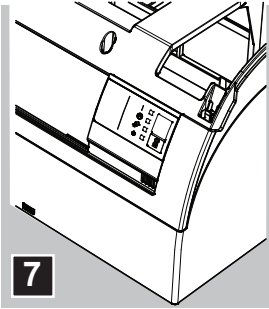

- Attach the front grill and service cover to the indoor unit according to installation manual of the indoor unit.

## 5. FIELD SETTING

If optional accessories are mounted on the indoor unit, the indoor unit setting may have to be changed. Refer to the instruction manual (optional hand book) for each optional accessory.

### Procedure

- When in the normal mode, press the button for a minimum of four seconds, and the FIELD SET MODE is entered.
- Select the desired MODE number with the button.
- Push the “” button and select the FIRST CODE number.
- Push the “” button and select the SECOND CODE number.
- Push the button and the present settings are SET.
- Push the button to return to the NORMAL MODE.

(Example)

If the time to clean air filter is set to “Filter Contamination-Heavy”, set MODE number to “10”, FIRST CODE number to “0”, and SECOND CODE number to “02”.

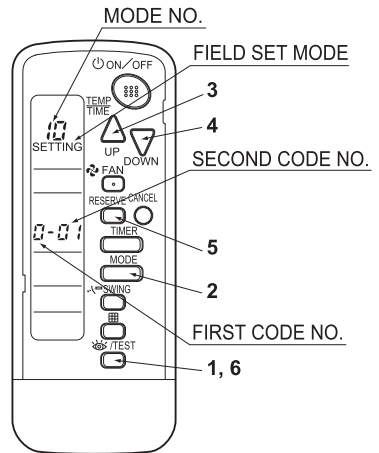

MODE number	FIRST CODE number	DESCRIPTION OF SETTING	SECOND CODE number NOTE)				
			01	02	03		
10	0	Filter Contamination-Heavy/Light (Setting for spacing time of display time to clean air filter) (Setting for when filter contamination is heavy, and spacing time of display time to clean air filter is to be halved)	Light	Approx. 200 hrs.	Heavy	Approx. 100 hrs.	–
	3	Spacing time of display time to clean air filter count (Setting for when the filter sign is not to be displayed)	Display		Do not display		–

12 (VRV system)	1	ON/OFF input from outside (Set to enable starting/stopping from remote.)	Forced OFF input	ON/OFF	–
	2	Thermostat differential changeover (Set when using remote controller thermostat sensor.)	1°C	0.5°C	–
13	0	Air flow rate increase mode (to be set upon user's request)	Standard	A little increase	Increase

**NOTE** 

- The SECOND CODE number is factory set to "01".

Do not use any settings not listed in the table.

For group control with a wireless remote controller, initial settings for all the indoor units of the group are equal. (For group control, refer to the installation manual attached to the indoor unit for group control.)

## 6. TEST OPERATION

- Perform test operation according to the instructions in the installation manual attached to the outdoor unit.

**[PRECAUTIONS]**

1. Refer to the installation manual attached to the outdoor unit for individual operation system types.

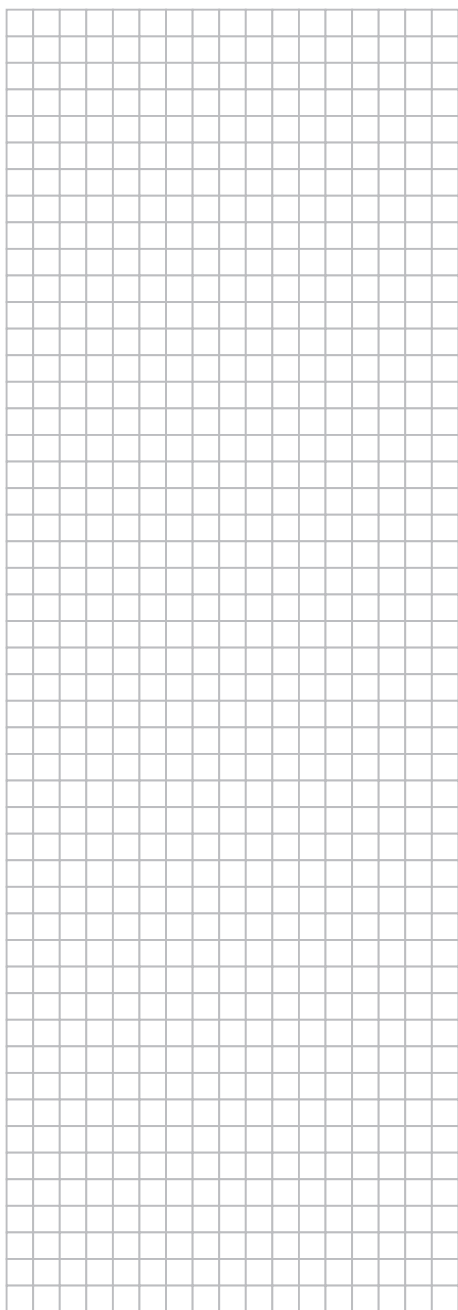
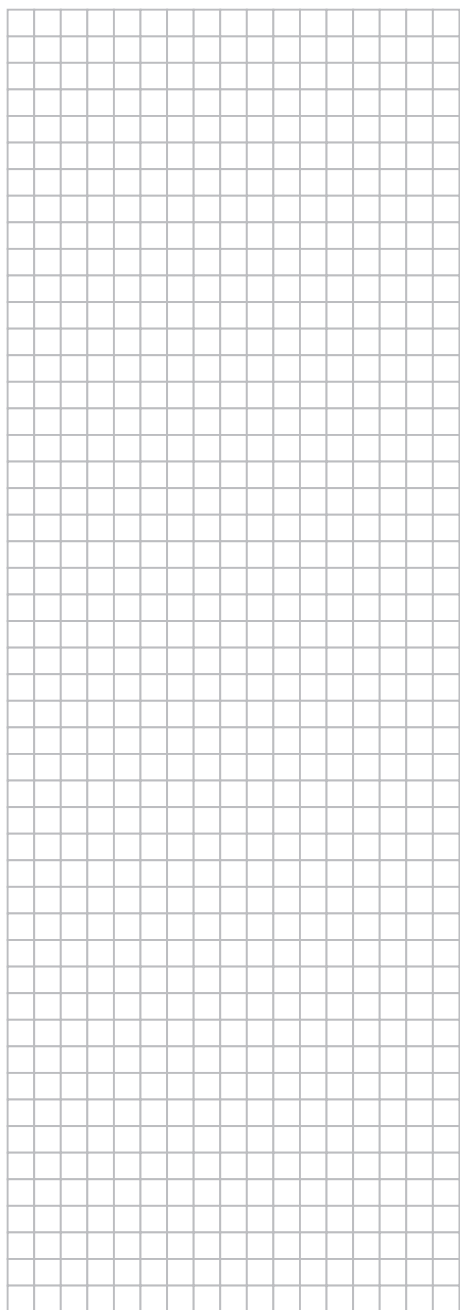

**DAIKIN EUROPE N.V.**

Zandvoordestraat 300, B-8400 Oostende, Belgium

Copyright 2017 Daikin