

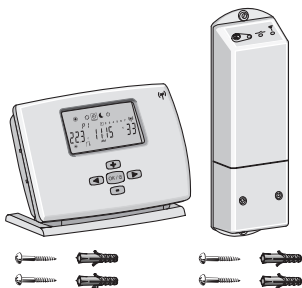

## INSTALLATION MANUAL

### Room thermostat

EKRTR  
EKRTETS



1



2

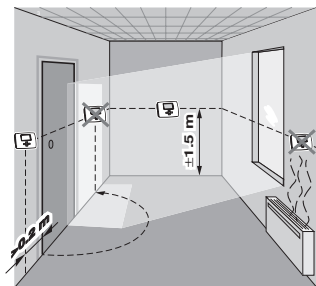

3

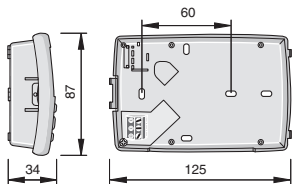

4

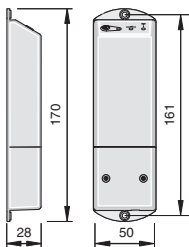

5



Read this manual attentively before starting up the unit. Do not throw it away. Keep it in your files for future reference.

---

The English text is the original instruction. Other languages are translations of the original instructions.

---



Improper installation or attachment of equipment or accessories could result in electric shock, short-circuit, leaks, fire or other damage to the equipment. Be sure only to use accessories made by Daikin which are specifically designed for the use with the equipment and have them installed by a professional.

If unsure of installation procedures or use, always contact your dealer for advice and information.

---

## Contents

1. Introduction .....	2
2. Installation of EKRTETS as floor temperature sensor (only for floor heating/cooling applications) .....	3
3. Installation of the EKRTR .....	6
4. Setting up codes in the installer menu .....	14
5. Technical characteristics .....	24

# 1. Introduction

The room thermostat EKRTR can be used to control the Daikin system (radiator heating and floor heating/cooling applications).

It is typically connected to the Daikin unit. Refer to the "Typical application examples" in the Installation manual of the Daikin unit.

- In case of floor heating-only applications the room thermostat can also be connected to the individual motorized valve of the floor heating loop.
- If a floor heating-only application is used in combination with fan coil units each fan coil unit should have its dedicated fan coil thermostat.

Optionally, an external temperature sensor EKRTETS can be connected to the thermostat and used as:

- external ambient temperature sensor to control the room temperature (instead of the temperature sensor inside the thermostat). In that case, install the temperature sensor where you want to control the ambient temperature.
- floor temperature sensor (only for floor heating/cooling applications) to protect the floor temperature or to prevent dew on the floor (in case of floor cooling). In that case, install the temperature sensor in the floor (refer to "[Installation of EKRTETS as floor temperature sensor \(only for floor heating/cooling applications\)](#)" on page 3).



In case of extreme or sudden changes in weather conditions, despite the dew prevention function, condensation on the floor could occur.

To avoid reoccurrence, we suggest changing the field settings (refer to "[Set-up floor temperature protection and dew prevention function \(only for floor heating/cooling applications\)](#)" on page 15).

In case the conditions are so extreme that this countermeasure is not adequate, we suggest not to use floor cooling.

---

## 2. Installation of EKRTETS as floor temperature sensor (only for floor heating/cooling applications)

As it should be integrated into the floor, the installation of the temperature sensor EKRTETS should be planned and performed in advance.

If EKRTETS is installed as floor temperature sensor, the thermostat EKRTR should be wall-mounted. Refer to "[Wall-mounted installation](#)" on page 6.

---

**NOTE** The below procedure only serves as an example.  
 Your actual situation may differ from what is represented here.

---

- 1 Take the installation suggestions for the thermostat into account when selecting the installation location.  
Refer to [figure 3](#).

- 2 Integrate the EKRTETS temperature sensor in an electrical conduit ( $\varnothing 16$  mm maximum) in the floor construction as shown below.

Make sure to seal the temperature sensor electrical conduit to protect the thermostat from hot air currents and to allow the replacement of the temperature sensor.

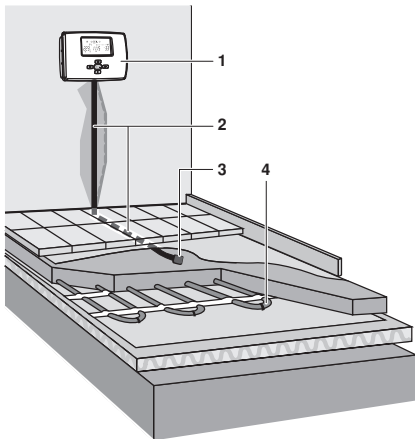

- 1 Thermostat
- 2 Temperature sensor conduit ( $\varnothing 16$  mm maximum)
- 3 Temperature sensor EKRTETS (in conduit with seal)
- 4 Water pipes

- 3 Pass the temperature sensor cable through the conduit until it reaches the seal.

- 4 Connect the temperature sensor cable to the thermostat as described in "[Wall-mounted installation](#)" on page 6.

---

**NOTE**

Install the temperature sensor as close as possible to the floor loop inlet and as close as possible to the floor surface as shown in the figure on [page 4](#).

---

### 3. Installation of the EKTRTR

You can mount the EKTRTR thermostat on the wall or use it as table-top model.

#### 3.1. Wall-mounted installation

The EKTRTR thermostat can be wall-mounted, with supplied screws and plugs. Refer to [figure 1](#).

This is the case when you want to install the optional EKRTETS as external temperature sensor.

- 1 At the left of the thermostat, gently push the lid.
- 2 Remove the front cover by pulling it towards you.
- 3 Optionally for the EKRTETS, unscrew the screw of the cable holder in the bottom left corner of the back part of the thermostat and remove the transparent cable protection.
- 4 Remove the battery insulator.

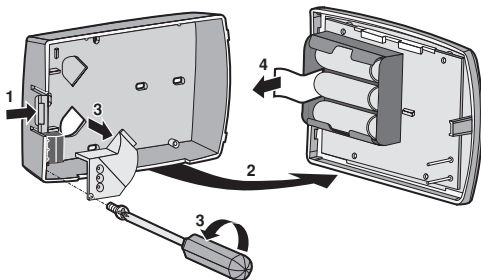

- 5 Drill holes in the wall taking the dimensions of the thermostat into account and insert the supplied plugs in the holes.  
Refer to [figure 4](#) (unit of measurement: mm).



- Optionally, pass the temperature sensor wiring (EKRTETS) through the back of the thermostat and wire it as shown below.

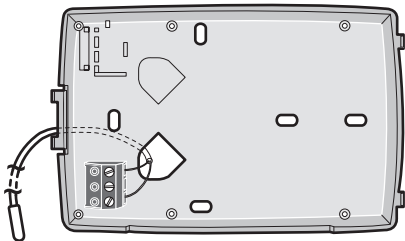

- Fasten the thermostat with the supplied screws.



Be careful not to pinch the wiring when fastening.

- Optionally for the EKRTETS, put the transparent cable protection back into place and fix the cable protection with the screw.
- Close the thermostat cover.
- Remove the protective film from the LCD.

### 3.2. Table-top installation of the thermostat

Only if the optional temperature sensor EKRTETS is not installed as external temperature sensor, the EKRTR can be used as a table-top model.

In that case, no particular installation for the thermostat is needed. The thermostat functions as a complete wireless unit and can be put anywhere in the house into its table holder.

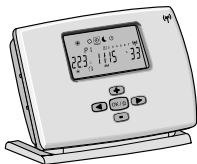

Remove the battery insulator and the protective film from the LCD, as described in "[Wall-mounted installation](#)" on page 6.

### 3.3. Installation of the receiver

The receiver needs to be installed indoors, typically close to the unit.



#### **Recommendations for an optimum signal reception**

Take the installation suggestions for the receiver into account when selecting the installation location and follow the recommendations below.

- Do not install the receiver inside a metal box.
- Mount the receiver vertically, and minimum 10 cm away from the unit.
- Mount the receiver minimum 10 cm away from any vertical metal pipe or vertical electric circuit.
- Mount the receiver at least 1.5 m above the ground.



Before obtaining access to terminals, all power supply circuits must be interrupted.

---

Keep the front clear at all times for access.

- 1 Drill holes in the wall taking the dimensions of the receiver into account and insert the supplied plugs in the holes.  
Refer to [figure 5](#).
- 2 Fasten the receiver with the supplied screws.
- 3 Unscrew both screws and remove the front cover.

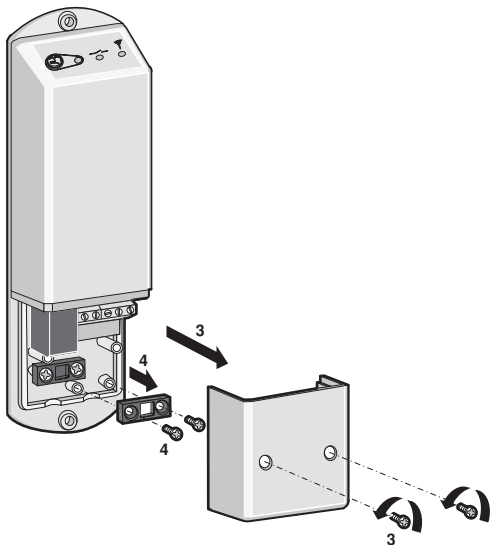

- 4 Unscrew both screws of the lower right cable bracket and remove the bracket.

5 According your application, perform the wiring.



All field wiring and components must be installed by a licensed electrician and must comply with relevant European and national regulations.

5a When connected to the unit, refer to the wiring diagram of the unit.

Example unit

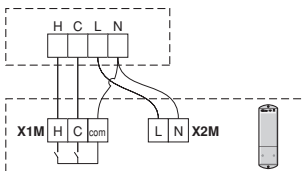

H	Heating demand
C	Cooling demand

For heating-only applications, wire connection to C is not to be installed.

Use wire size 0.75~1.50 mm<sup>2</sup>.

5b When connected to the motorized valve, wire the motorized valve and the receiver as shown below (for heating-only applications).

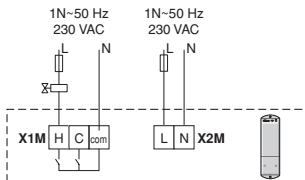

The output relays (H and C are voltage-free contacts) can handle a maximum load of 4 A - 230 VAC.



Make sure to protect the power supply with a fuse of 3 A (X2M).









Select the power cable in accordance with relevant local and national regulations.

A main switch or other means for disconnection, having a contact separation in all poles, must be incorporated in the fixed wiring in accordance with relevant local and national legislation.



- 6 Put the cable bracket back into place and tighten the screws.
- 7 Close the receiver cover and tighten the screws.

### Receiver-thermostat radio configuration



You need to configure the radio connection between the receiver and the thermostat in order to make communication possible.

- 1 Put the receiver in radio configuration mode by pressing  during 4 seconds.  
The  LED lights up green and the receiver is now waiting for a thermostat configuration address.  
If needed, you can simply exit this mode by pressing  again.
- 2 Send the configuration address by going to code 5r 03 (r f l n t) in the installer menu on the thermostat.  
Refer to ["Setting up codes in the installer menu" on page 14](#).  
The thermostat will now send radio signals. On the LCD the icon  flashes.
- 3 Verify that the radio signals are correctly received by the receiver.  
If the configuration is OK, the  LED blinks green at each radio signal received from the thermostat.  
This also means that the receiver has left the radio configuration mode.
- 4 On the thermostat, exit the installer menu by pressing  till the "End" code is displayed and then pressing .
- 5 Verify if the receiver is in thermostat mode and not in manual mode by checking if the  LED is off.  
Refer to ["LED overview" on page 12](#).

## LED overview

			Meaning
OFF	RED	OFF	Thermostat mode: Heating demand
OFF	GREEN	OFF	Thermostat mode: Cooling demand
YELLOW	RED	OFF	Manual mode: forced heating
YELLOW	GREEN	OFF	Manual mode: forced cooling
YELLOW	OFF	OFF	Manual mode: forced OFF
YELLOW/ OFF	GREEN/ RED/OFF	GREEN: Quick short blink	Communication between receiver and thermostat
YELLOW/ OFF	GREEN/ RED/OFF	GREEN: continuous	Receiver in radio configuration mode
OFF	OFF	GREEN: slow blink	There is no longer communication between the receiver and the thermostat both heating and cooling demand is stopped. A manual override is still possible (refer to "Manual control" on page 13).

## Manual control

You can use the receiver to manually override the heating or cooling command of the thermostat when for example the batteries of the EKRTTR are empty or when the thermostat is broken. Manual control is activated when the  LED lights up yellow. In thermostat mode the  LED is off.

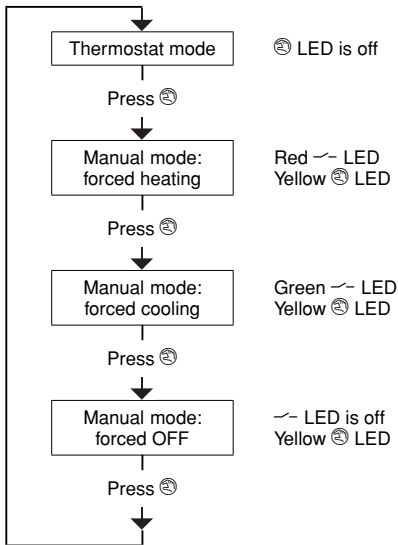

## 4. Setting up codes in the installer menu

You can set up codes, starting from the time and date menu (in advanced mode).

**NOTE** As a consequence of a customized configuration, it is not abnormal that some codes are no longer accessible.



- 1 Activate the advanced mode by pushing during 5 seconds in OFF mode ().
- 2 Navigate to the date and clock setting menu () by pressing .
- 3 Press and keep it pressed while now pressing during 10 seconds.  
 is displayed next to 4r.

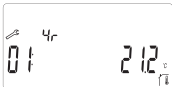

- 4 Press or to consult the current settings of the codes.
  - 5 To modify codes, press , or .
  - The value is flashing when being modified.
  - 6 Press or to increase or decrease the code value by 1 step.  
To put a code back to its default value, press and at the same time.
  - 7 Press to save your selection.  
You can exit this code menu by going to the "End" code and pressing .
- Refer also to "Overview of all codes" on page 18.



#### 4.1. Set-up for Fahrenheit degree type

Refer to the operation manual how to change parameter in user menu.

1st code	2nd code	Description	Range
lr	01	Degrees type.	°C/°F

#### 4.2. Set-up for heating/cooling applications

For heating/cooling applications, set the following codes:

1st code	2nd code	Description	Required setting
5r	01	Cooling mode present?	YES

#### 4.3. Set-up floor temperature protection and dew prevention function (only for floor heating/cooling applications)

If EKRTETS is installed as floor temperature sensor it can be used to manage and thus protect the floor temperature. Refer to "[Installation of EKRTETS as floor temperature sensor \(only for floor heating/cooling applications\)](#)" on page 3. When this function is active the icon  flashes below the ambient temperature.

In cooling mode, the dew prevention function will make sure there will be no condensation on the floor. The dew point is calculated based on room temperature and room humidity. When the floor temperature drops below the dew point the cooling demand will be temporarily stopped and the icon  is displayed.

To enable floor protection, set the following codes:

1st code	2nd code	Description	Required setting	Step
5r	02	External temperature sensor EKRTETS installed?	YES	—
7r	01	Enable floor high/low temperature limit?	YES	—
	02	Lower limit of floor temperature	19.0 <sup>(a)</sup>	0.5°C
			64.5 <sup>(a)</sup>	0.5°F
	03	Upper limit of floor temperature	35.0 <sup>(b)</sup>	0.5°C
95.0 <sup>(b)</sup>			0.5°F	

(a) Can be modified as preferred.

(b) Default value. Can be modified as preferred.

To enable dew prevention, set the following codes:

**NOTE**  The dew prevention function can only be enabled if floor temperature protection is enabled (refer to the table above).

1st code	2nd code	Description	Required setting	Step
7r	04	Enable dew prevention function?	YES	—
	05	Offset for dew point calculation	03.0	0.1°C
			05.4	0.2°F
06	Display result of dew point calculation	Consult only	—	



Should condensation on the floor occur, we suggest increasing field settings 7r 02 and 7r 05. In case the conditions are so extreme that this countermeasure is not adequate, we suggest not to use floor cooling.

#### 4.4. Set-up for EKRTETS as external ambient temperature sensor

EKRTETS can be used as external ambient temperature sensor to control the room temperature (instead of the temperature sensor inside the thermostat). In that case, install the external temperature sensor where you want to control the ambient temperature.

To enable the function, set the following codes:

1st code	2nd code	Description	Required setting
5r	02	External temperature sensor EKRTETS installed?	YES
6r	01	Selection of sensor for temperature control: use external ambient temperature sensor?	YES

**NOTE** This function cannot be combined with floor temperature protection and dew prevention.







#### 4.5. Set-up for radiator applications

Before operation, change the following temperature control parameter to the required setting for radiator applications.

1st code	2nd code	Description	Required setting
6r	02	Use proportional band control?	no (=hysteresis)

## 4.6. Overview of all codes

Following codes can be changed in the installer menu:

1st code	2nd code	Description	Default	Range	Step
<b>Readout codes</b>					
4r	01 + 	Calibration of temperature sensor inside the thermostat. Actual temperature + offset are displayed. The  symbol appears when the offset deviates from 0.	Offset = 0	Offset: -5°C~5°C	0.1°C
				Offset: -9°F~9°F	0.2°F
02 + 		Calibration of external temperature sensor. Actual temperature + offset are displayed. The  symbol appears when the offset deviates from 0.	Offset = 0	Offset: -5°C~5°C	0.1°C
				Offset: -9°F~9°F	0.2°F
03		Calibration of humidity sensor. Actual humidity + offset are displayed. The  symbol appears when the offset deviates from 0.	Offset = 0	Offset: 10%	1%

1st code	2nd code	Description	Default	Range	Step
<b>Installation codes</b>					
5r	01	Cooling mode present?	no	YES/no	—
	02	External temperature sensor EKRTETS installed?	no	YES/no	—
	03	rfi n t and (P) are displayed on the LCD. This code is used during the receiver-thermostat radio configuration. Refer to "Receiver-thermostat radio configuration" on page 11.	—	—	—
<b>Temperature control codes</b>					
6r	01	Selection of sensor for temperature control: use external ambient temperature sensor?	no	YES (use external temperature sensor)/ no (use temperature sensor inside the thermostat)	—

1st code	2nd code	Description	Default	Range	Step
Daikin advises not to change below temperature control parameters. They are set for an optimal use of the Daikin system.					
6r	02	Use proportional band control?	YES	YES (proportional band)/no (hysteresis)	—
	03	Hysteresis value	005	005~020	0.1°C
			009	009~036	0.1°F
	04 + ☀	Duration proportional band (heating).	020	0 10~060	1 min.
	05 + ☀	Minimum "on" time (heat demand).	009	002~ 6r 04/2	1 min.
	06 + ☀	Minimum delay between 2 heating cycles.	005	001~ 6r 04/2	1 min.
	07 + ❄	Duration proportional band (cooling).	020	0 10~060	1 min.
	08 + ❄	Minimum "on" time (cool demand).	007	002~ 6r 07/2	1 min.
	09 + ❄	Minimum delay between 2 cooling cycles.	003	001~ 6r 07/2	1 min.
	10	Value of proportional band.	020	0 10~040	0.1°C
			036	0 18~072	0.1°F
	11	Not used parameter	—	—	—
12	Upper setpoint limitation.	370	220~370	0.5°C	
		990	720~990	0.5°F	

1st code	2nd code	Description	Default	Range	Step
6r	13	Lower setpoint limitation (for heating only units).	04.0	04.0~20.0	0.5°C
			39.5	39.0~68.0	0.5°F
<b>Floor temperature limit and dew prevention codes</b>					
7r	01	Enable floor high/low temperature limit?	no	YES/no	—
	02	Lower limit of floor temperature.	18.0	05.0~Upper limit (7r 03)	0.5°C
			64.5	41.0~Upper limit (7r 03)	0.5°F
	03	Upper limit of floor temperature.	35.0	Lower limit (7r 02)~50.0	0.5°C
			95.0	Lower limit (7r 02)~122	0.5°F (>99.5 = 1°F)
	04	Enable dew prevention function?	no	YES/no	—
	05	Offset for dew point calculation.	03.0	-10.1~09.9	0.1°C
05.4			-18.2~17.9	0.2°F	
06 + 	Display result of dew point calculation.	—	—	—	

1st code	2nd code	Description	Default	Range	Step
<b>Schedule timer codes</b>					
8r	01	Enable cooling/heating link for the user-defined schedules 01 and 02? When enabled and a user-defined schedule is selected in the schedule timer setting menu: in heating mode, schedule 01 will be active; in cooling mode, schedule 02 will be active.	no	YES/no	—



1st code	2nd code	Description	Default	Range	Step
<b>Miscellaneous codes</b>					
9r	01	Daylight saving time implementation.	YES	YES/no	—
	02 + ☀	Forced heating (installation check).	no	YES/no	—
	03 + ❄	Forced cooling (installation check).	no	YES/no	—
	15 + rESEtALL	Reset all settings back to factory configuration. Press  during 5 seconds. The complete LCD is shown to confirm all settings are reset.	—	—	—



After resetting all settings back to factory configuration (15+rESEtALL), the parameters must be changed manually again.

## 5. Technical characteristics

### 5.1. EKRTR - Thermostat

Temperature read out	Steps of 0.1°C/0.1°F
Operating temperature	0°C~50°C/32°F~122°F
Setpoint temperature range	4°C~37°C in steps of 0.5°C/ 39.5°F~99°F in steps of 0.5°F
Electrical protection	Class II - IP30 (indoor use, pollution degree 2)
Feeding and autonomy	3 alkaline batteries AA.LR6 1.5 V approximately 2 years (depending on usage conditions)

### 5.2. EKRTR - Receiver

Operating temperature	0°C~50°C/32°F~122°F
Electrical protection	Class II - IP44 (indoor use, pollution degree 2)
Power supply	1N~50 Hz 230 VAC
Radio frequency and receiving zone	433.92 MHz, <10 mW. Range of approximately 100 m in open space. Range of approximately 30 m in residential environment.
Output relays	Maximum load 4 A - 230 VAC
Maximum fuse amp	3 A
Power consumption	15 W, maximum.
Immunity against voltage surges	Category III (2.5 kV)
Type of automatic action of the thermostat	1C

### 5.3. EKRTETS (optional)

External temperature sensor	NTC 10K at 25°C/3 meter lead/ NTC 10K at 77°F/3 meter lead
-----------------------------	---

## NOTES

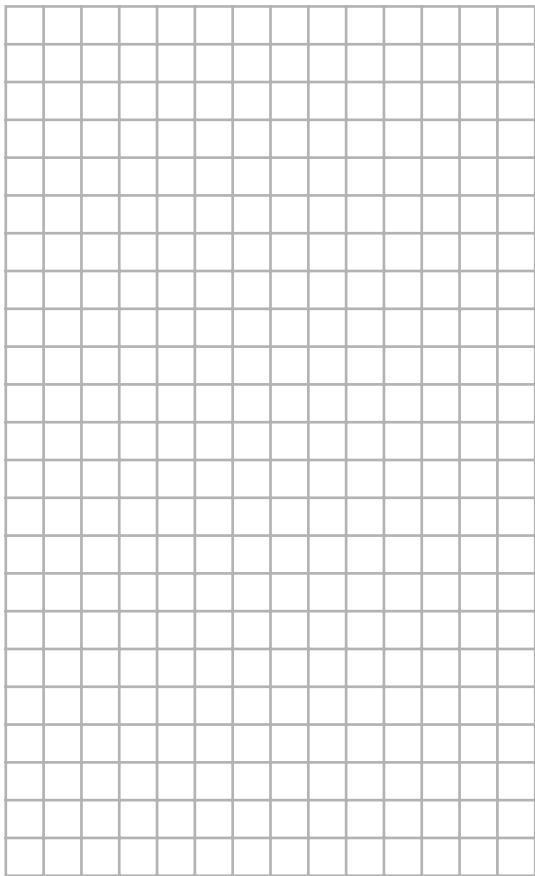



\*4PW56105-1 00000004\*

Copyright 2010 Daikin

**DAIKIN EUROPE N.V.**

Zandvoordestraat 300, B-8400 Oostende, Belgium

4PW56105-1