

DAIKIN



INSTALLATION MANUAL

Outdoor unit for air to water heat pump

ERHQ006BAV3
ERHQ007BAV3
ERHQ008BAV3

ERLQ006BAV3
ERLQ007BAV3
ERLQ008BAV3

CE - DECLARATION-OF-CONFORMITY
CE - KONFORMITÄTSPRÄKLÄRUNG
CE - DECLARATION-DE-CONFORMITE
CE - CONFORMITEITSVERKLARING

Daikin Europe N.V.

- 01 (GB) declares under its sole responsibility that the equipment to which this declaration relates:
02 (E) erklärt auf seine alleinige Verantwortung, dass die Ausrüstung für die diese Erklärung bestimmt ist:
03 (F) déclare sous sa seule responsabilité que l'équipement visé par la présente déclaration:
04 (NL) verklaart hierbij op eigen exclusieve verantwoordelijkheid dat de apparatuur waarop deze verklaring betrekking heeft:
05 (E) declara bajo su única responsabilidad que el equipo al que hace referencia la declaración:
06 (I) dichiara sotto la propria responsabilità che gli apparecchi a cui è riferita questa dichiarazione:
07 (GR) δηλώνει με αποκλειστική της ευθύνη ότι ο εξοπλισμός στον οποίο αναφέρεται η παρούσα δήλωση:
08 (P) declara sob sua exclusiva responsabilidade que os equipamentos a que esta declaração se refere:

ERHQ006BAV3, ERHQ007BAV3, ERHQ008BAV3,
ERLQ006BAV3, ERLQ007BAV3, ERLQ008BAV3,

- 01 are in conformity with the following standard(s) or other normative document(s), provided that these are used in accordance with our instructions:
02 der/den folgenden Norm(en) oder einem anderen Normdokument oder Dokumenten entsprechend entsprechen, unter der Voraussetzung, daß sie gemäß unserer Anweisungen eingesetzt werden:
03 são conformes à(s) norma(s) ou documento(s) normatívo(s), para autant qu'ils soient utilisés conformément à nos instructions:
04 conform de volgen de norm(en) of één of meer andere bindende documenten zijn, op voorwaarde dat ze worden gebruikt overeenkomstig onze instructies:
05 están en conformidad con la(s) siguiente(s) norma(s) u otro(s) documento(s) normativos), siempre que sean utilizados de acuerdo con nuestras instrucciones:
06 sono conformi alle/i seguente/i standard(i) o altro(i) documento(i) a carattere normativo, a patto che vengano usati in conformità alle nostre istruzioni:
07 είναι σύμφωνα με τις οδηγίες μας, υπό την προϋπόθεση ότι χρησιμοποιούνται σύμφωνα με τις οδηγίες μας.

EN60335-2-40,

- 01 under the provisions of:
02 gemäß den Vorschriften der:
03 conformément aux stipulations des:
04 overeenkomstig de bepalingen van:
05 siguiendo las disposiciones de:
06 secondo le prescrizioni per:
07 με τηρών τον δικό τους τω:
08 de acordo com o previsto em:
09 в соответствии с положениями:
10 under kapitelse af bestemmelserne i:
11 enligt villkoren i:
12 gilt i henhold til bestemmelserne i:
13 roudatteen määräyksissä:
14 za doordien ustanoveni predpisu:
15 prema odredbama:
16 követi a(z):
17 zgodnie z postanowieniami Dyrekty:
18 in urma prevederilor:

- 01 Note * as set out in and judged positively by
according to the Certificate .
02 Hinweis * wie in der aufgeführt und von positiv beurteilt gemäß Zertifikat .
03 Remarque * tel que défini dans et évalué positivement par conformément au Certificat .
04 Bemerk * zoals vermeld in en positief beoordeeld door overeenkomstig Certificaat .
05 Nota * como se establece en y es valorado positivamente por de acuerdo con el Certificado .
06 Nota * delineato nei e giudicato positivamente da secondo il Certificato .
07 Znakovon * ovnk, vobojzeto stro kai kvletra Bemd onto to ekupwto me to Plromonimio .
08 Nota * tal como estabelecido em e com o parecer positivo de de acordo com o Certificado .
09 Примечание * как указано в и в соответствии с содержанием решения согласно Сертификату .
10 Bemerk * som anført i og positivt vurderet af i henhold til Certifikat .

CE - DECLARACÃO-DE-CONFORMIDADE
CE - ZARBIENIE-O-COOTBECTBIM
CE - OPYJDELSESERKLÆRING
CE - FÖRSÄKRAN-OM ÖVERENSSTÄMMELSE

CE - IZJAVA-O-USKLABENOSTI
CE - MEGFELELŐSÉG-NYILATKOZAT
CE - DEKLARACJA-ZGODNOSCI
CE - DECLARAȚIE-DE-CONFORMITATE

CE - IZJAVA O SKLADNOSTI
CE - VASTAVUSDEKLARACIJA
CE - VYHLÁSENIE-ZHODY
CE - UYUMLUKULUK-BİLDİRİSİ

CE - ATTIKITES-DEKLARACIA
CE - ATBLISTIBAS-DEKLARACIJA
CE - VYHLÁSENIE-ZHODY
CE - UYUMLUKULUK-BİLDİRİSİ

- 09 (GB) заявляет, исключительно под свою ответственность, что оборудование, к которому относится настоящее заявление:
10 (GB) erklærer som eneste ansvarlig, at udstyret, som er omfattet af denne erklæring:
11 (S) deklarerar i egeniskaft og huvudsakligen, att utrustningen som berörs av denna deklARATION innehåller att:
12 (N) erklærer et fuldstændigt ansvar for det udstyr som berøres af denne deklARATION, indbæret at:
13 (NL) imrotaaz yseivomaan omalla vastuullaan, että tämän ilmoituksen tarkoituksena on laittaa:
14 (E) prohlašuje ve své plné odpovědnosti, že zařízení, k němuž se toto prohlášení vztahuje:
15 (GR) δηλώνει υπό αποκλειστική του ευθύνη ότι ο εξοπλισμός στον οποίο αναφέρεται η παρούσα δήλωση:
16 (P) tejeis felelséggel tudatában kijelenti, hogy a berendezések, melyekre e nyilatkozat vonatkozik:

- 17 (PL) deklaruje na własną wyłączną odpowiedzialność, że urządzenie, których ta deklaracja dotyczy:
18 (GB) declares under its sole responsibility that the equipment to which this declaration relates:
19 (E) erklärt auf seine alleinige Verantwortung, dass die Ausrüstung für die diese Erklärung bestimmt ist:
20 (F) déclare sous sa seule responsabilité que l'équipement visé par la présente déclaration:
21 (NL) verklaart hierbij op eigen exclusieve verantwoordelijkheid dat de apparatuur waarop deze verklaring betrekking heeft:
22 (E) declara bajo su única responsabilidad que el equipo al que hace referencia la declaración:
23 (I) dichiara sotto la propria responsabilità che gli apparecchi a cui è riferita questa dichiarazione:
24 (GR) δηλώνει με αποκλειστική της ευθύνη ότι ο εξοπλισμός στον οποίο αναφέρεται η παρούσα δήλωση:
25 (P) declara sob sua exclusiva responsabilidade que os equipamentos a que esta declaração se refere:

- 08 estão em conformidade com a(s) seguinte(s) norma(s) ou outro(s) documento(s) normativo(s), desde que estes sejam utilizados de acordo com as nossas instruções:
09 соответствуют следующим стандартам или другим нормативным документам, при условии их использования согласно нашим инструкциям:
10 ovenholder følgende standard(er) eller andre andre retningsgivende dokument(er), brudsat at disse anvendes i henhold til vore instrukser:
11 respektive utrustning är utförd i överensstämmelse med och följer följande standard(er) eller andra normgivande dokument, under förutsättning att användning sker i överensstämmelse med våra instruktioner:
12 respektive udstyr er i overensstemmelse med følgende standard(er) eller andre normgivende dokument(er), under forudsætning at disse brudes i henhold til vore instrukser:
13 nastavaq searaaven standarden ja muiden ohjeellisten dokumenttien vaatimuksia edellyttäen, että niitä käytetään ohjeidemme mukaisesti:
14 za předpokladu, že jsou využívány v souladu s našimi pokyny, odpovídají následujícím normám nebo normativním dokumentům:
15 u skladu sa slijedeći standard(ima) ili drugim normativnim dokument(ima), uz uvjet da se oni koriste u skladu s našim uputama:

Low Voltage 2006/95/EC Machinery 98/37/EC (→ 29.12.2009) Electromagnetic Compatibility 2004/108/EC *

- 11 Information * enligt och godkänts av enligt Certifikat .
12 Merk * som det fremkommer i og gennem positiv bemærkelse af lølge Serifikat .
13 Huom * jalka cum este stabilit în și arecaz pozitiv în valsoarea Serifikatului .
14 Poznámka * jak bylo uvedeno v a pozitivně zjišeno v souladu s osvědčením .
15 Napomena * kako je izloženo u pozitivno ocijenjeno od strane prema Certifikatu .
16 Megjegyzás * a(z) alapján, a(z) igazolta a megfelelést, a(z) tanúsítvány szerint.
17 Uwaga * zgodnie z dokumentacją pozytywną opinią Swiadectwem .
18 Nota * așa cum este stabilit în și arecaz pozitiv în valsoarea Serifikatului .
19 Opomba * koji je dobio u in odobreno s strani v skladu s osvedčenim .
20 Märkus * ragu on näidatud dokumentis ja heaks kiidetud järgi vastavalt serifikatidele .

- 01 Directives, as amended.
02 Direktiven, gemäß Änderung.
03 Directives, telles que modifiées.
04 Richtlijnen, zoals gewijzigd.
05 Directivas, según lo emendado.
06 Directive, come da modifica.
07 Οδηγίες, όπως έχουν τροποποιηθεί.
08 Directivas, conforme alteração em.
09 Директиве со всеми поправками.
10 Direktiver, med senere ændringer.
11 Direktiv, med foretagne ændringer.
12 Direktiven, с тексаре изменения.
13 Direktiwe, so gewijzigd.
14 plátmen znení.
15 Smerice, kako je izmijenio.
16 irányelvek és módosítások rendelkezéseit.
17 pözüvejszy popravkami.
18 Directievor, cu amendamentele respective.

- 21 Zabeleška * карта е изложено в у ошенио попокирено от согласно Сертификату .
22 Pastaba * kaip nustatyta ir kaip teigiamai nuspreta pagal Serifikatą .
23 Poznámka * kā norādīts un atbilstoš pozitīvajam vērtējumam saistībā ar serifikatu .
24 Poznámka * ako bolo uvedené v a pozitívne zistené v súlade s osvedčením .
25 Not * da bejrtitligi gibi, ve Serifikasina gőre tarandán otmu olarak deęenderindőđ gibi.

- 16 megfelelnek az alábbi szabvány(ok)nak vagy egyéb irányadó dokumentum(ok)nak, ha azokat előírás szerint használják.
17 megfelel a következők normáinak vagy egyéb dokumentum normalizációs, pod varumnik ve užyvane sa, zgodnie z naszymi instrukcjami:
18 sunt în conformitate cu următorii (următoare) standarde (sau altele) documentale (normative), cu condiția ca acestea să fie utilizate în conformitate cu instrucțiunile noastre.
19 skilnads näsleđjiga standard i dögjiga normativ, pod popogem, da se uporabljajo v skladu z našimi navodili:
20 on vastavusse järgmistele standarditele või teiste normatiivsete dokumentidele, kui need kasutatakse vastavalt meie juhenditele:
21 соответствует на следующие стандарты или другие нормативные документы, при условии, что се используют согласно нашим инструкциям:
22 atitinka žemiau nurodytus standartus ir (arba) kitus norminius dokumentus su sąlyga, kad yra naudojami pagal mūsų nurodymus:
23 tad, ja leiboti atbilstošie rozdzajki norudėjimai, atbisi sekėjosiems standartim an citem normatiivm dokumentim:
24 sú v zhode s nasledovnými normami (nebo jinými) normativními (nebo dokumentárními), za předpokladu, že sa používajú v súlade s našimi návodmi:
25 inünin, talimatlarına göre kullanılması kopyulaya eşđđđđđđ standartlar ve norm belirlen belgelerle uyumludur:



CONTENTS

	Page
Safety precautions.....	1
Model.....	3
Accessories.....	3
Installation guidelines.....	3
Precautions for selecting the location.....	3
Selecting a location in cold climates.....	4
Refrigerant piping specifications.....	4
Installing near a wall or obstacle.....	4
Outdoor unit installation drawing.....	5
Installation procedure.....	5
Mounting the outdoor unit.....	5
Drain work.....	5
Flaring the pipe end.....	5
Connecting the refrigerant piping to the outdoor unit.....	6
Refrigerant piping work.....	6
Purging air and checking gas leakage.....	6
Charging refrigerant.....	7
Wiring.....	8
Test run and final check.....	10
Trial operation and testing.....	10
Items to check.....	10
Pump down operation.....	10
Pump down procedure.....	10
Forced cooling operation.....	10
Maintenance and servicing.....	11
Service precautions.....	11
Service mode operation.....	11
Disposal requirements.....	11
Unit specifications.....	11
Technical specifications.....	11
Electrical specifications.....	11



READ THESE INSTRUCTIONS CAREFULLY BEFORE INSTALLATION. KEEP THIS MANUAL IN A HANDY PLACE FOR FUTURE REFERENCE.

IMPROPER INSTALLATION OR ATTACHMENT OF EQUIPMENT OR ACCESSORIES COULD RESULT IN ELECTRIC SHOCK, SHORT-CIRCUIT, LEAKS, FIRE OR OTHER DAMAGE TO THE EQUIPMENT. BE SURE ONLY TO USE ACCESSORIES MADE BY DAIKIN WHICH ARE SPECIFICALLY DESIGNED FOR USE WITH THE EQUIPMENT AND HAVE THEM INSTALLED BY A PROFESSIONAL.

ALL ACTIVITIES DESCRIBED IN THIS MANUAL SHALL BE CARRIED OUT BY A LICENSED TECHNICIAN.

BE SURE TO WEAR ADEQUATE PERSONEL PROTECTION EQUIPMENT (PROTECTION GLOVES, SAFETY GLASSES, ...) WHEN PERFORMING INSTALLATION, MAINTENANCE OR SERVICE TO THE UNIT.

IF UNSURE OF INSTALLATION PROCEDURES OR USE, ALWAYS CONTACT YOUR DAIKIN DEALER FOR ADVICE AND INFORMATION.

The English text is the original instruction. Other languages are translations of the original instructions.

SAFETY PRECAUTIONS

The precautions listed here are divided into the following four types. They all cover very important topics, so be sure to follow them carefully.

Meanings of **DANGER**, **WARNING**, **CAUTION** and **NOTE** symbols.



DANGER

Indicates an imminently hazardous situation which, if not avoided, will result in death or serious injury.

WARNING

Indicates a potentially hazardous situation which, if not avoided, could result in death or serious injury.

CAUTION

Indicates a potentially hazardous situation which, if not avoided, may result in minor or moderate injury. It may also be used to alert against unsafe practices.

NOTE

Indicates situations that may result in equipment or property-damage accidents only.

- After completing installation, test the unit to check for installation errors. Give the user adequate instructions concerning the use and cleaning of the unit as included in the operation manual of the indoor unit.

Danger

- Before touching electric terminal parts, turn off power switch.
- When service panels are removed, live parts can be easily touched by accident.
 Never leave the unit unattended during installation or servicing when the service panel is removed.
- Do not touch water pipes during and immediately after operation as the pipes may be hot. Your hand may suffer burns. To avoid injury, give the piping time to return to normal temperature or be sure to wear proper gloves.

Warning

- Ask your dealer or qualified personnel to carry out installation work. Do not install the machine by yourself. Improper installation may result in water leakage, electric shocks or fire.
- Perform installation work in accordance with this installation manual. Improper installation may lead to water leakage, electric shocks or fire.
- Consult your local dealer regarding what to do in case of refrigerant leakage. When the unit is to be installed in a small room, it is necessary to take proper measures so that the amount of any leaked refrigerant does not exceed the concentration limit in the event of a leakage. Otherwise, this may lead to an accident due to oxygen depletion.
- Be sure to use only the specified accessories and parts for installation work. Failure to use the specified parts may result in water leakage, electric shocks, fire, or the unit falling.
- Install the unit on a foundation that can withstand its weight. Insufficient strength may result in the fall of equipment and causing injury.

- Carry out the specified installation work in consideration of strong winds, typhoons, or earthquakes. Improper installation work may result in accidents due to fall of equipment.
- Make certain that all electrical work is carried out by qualified personnel according to the local laws and regulations and this installation manual, using a separate circuit. Insufficient capacity of the power supply circuit or improper electrical construction may lead to electric shocks or fire.
- Make sure that all wiring is secure, using the specified wires and ensuring that external forces do not act on the terminal connections or wires. Incomplete connection or fixing may cause a fire.
- When wiring between the indoor and outdoor units, and wiring the power supply, form the wires so that the side panel can be securely fastened. Install covers over the wires. If the side panel is not in place, overheat of the terminals, electric shocks or a fire may be caused.
- If refrigerant gas leaks during installation work, ventilate the area immediately. Toxic gas may be produced if refrigerant gas comes into contact with fire.
- Do not touch the refrigerant pipes during and immediately after operation as the refrigerant pipes may be hot or cold, depending on the condition of the refrigerant flowing through the refrigerant piping, compressor, and other refrigerant cycle parts. Your hands may suffer burns or frostbite if you touch the refrigerant pipes. To avoid injury, give the pipes time to return to normal temperature or, if you must touch them, be sure to wear proper gloves.
- After completing the installation work, check to make sure that there is no leakage of refrigerant gas. Toxic gas may be produced if refrigerant gas leaks into the room and comes into contact with a source of fire, such as a fan heater, stove or cooker.
- When planning to relocate former installed units, you must first recover the refrigerant after the pump down operation. Refer to chapter "Pump down operation" on page 10.
- Never directly touch any accidental leaking refrigerant. This could result in severe wounds caused by frostbite.
- Be sure to install an earth leakage circuit breaker in accordance with relevant local and national regulations. Failure to do so may cause electrical shock and fire.
- Electrical work must be carried out in accordance with the installation manual and the national electrical wiring rules or code of practice. Insufficient capacity or incomplete electrical work may cause electrical shock or fire.
- Be sure to use a dedicated power circuit. Never use a power circuit shared by another appliance.
- For wiring, use a cable long enough to cover the entire distance with no connection. Do not use an extension cord. Do not put other loads on the power supply, use a dedicated power circuit. Failure to do so may cause abnormal heat, electric shock, or fire.
- During pump down operation, stop the compressor before removing the refrigerant piping. If the compressor is still running and the stop valve is open during pump-down, air will be sucked in when the refrigerant piping is removed, causing abnormal pressure in the freezer cycle which will lead to breakage and even to injury.
- During installation, attach the refrigerant piping securely before running the compressor. If the compressor is not attached and the stop valve is open during pump-down, air will be sucked in when the compressor is running, causing abnormal pressure in the freezer cycle which will lead to breakage and even to injury.

Caution

- Earth the unit. Earthing resistance should be according to national regulations. Do not connect the earth wire to gas or water pipes, lightning conductor or telephone earth wire. Incomplete earthing may cause electric shocks. 
- Gas pipe. Ignition or explosion may occur if the gas leaks.
- Water pipe. Hard vinyl tubes are not effective earths.
- Lightning conductor or telephone earth wire. Electric potential may rise abnormally if struck by a lightning bolt.
- Install drain piping according to this installation manual to ensure good drainage, and insulate the pipe to prevent condensation. See combination table in "Possible options" on page 3. Improper drain piping may cause water leakage, and make the furnitures get wet.
- Install the indoor and outdoor units, power wire and connecting wire at least 1 meter away from televisions or radios to prevent image interference or noise. (Depending on the radio waves, a distance of 1 meter may not be sufficient to eliminate the noise.)
- Do not rinse the outdoor unit. This may cause electric shocks or fire.
- Do not install the unit in places such as the following:
 - Where there is mist of mineral oil, oil spray or vapour for example a kitchen. Plastic parts may deteriorate, and cause them to fall out or water to leak.
 - Where corrosive gas, such as sulphurous acid gas, is produced. Corrosion of copper pipes or soldered parts may cause the refrigerant to leak.
 - Where there is machinery which emits electromagnetic waves. Electromagnetic waves may disturb the control system, and cause malfunction of the equipment.
 - Where flammable gases may leak, where carbon fiber or ignitable dust is suspended in the air or where volatile flammables, such as thinner or gasoline, are handled. Such gases may cause a fire.
 - Where the air contains high levels of salt such as that near the ocean.
 - Where voltage fluctuates a lot, such as that in factories.
 - In vehicles or vessels.
 - Where acidic or alkaline vapour is present.
- Do not allow a child to mount on the outdoor unit or avoid placing any object on the unit. Falling or tumbling may result in injury.
- For use of units in applications with temperature alarm settings it is advised to foresee a delay of 10 minutes for signalling the alarm in case the alarm temperature is exceeded. The unit may stop for several minutes during normal operation for "defrosting the unit", or when in "thermosta-stop" operation.
- Tighten the flare nut according to the specified method such as with a torque wrench. If the flare nut is tightened too hard, the flare nut may crack after a long time and cause refrigerant leakage.

MODEL

ERLQ units include special equipment (insulation, bottom plate heater,...) to ensure good operation in areas where low ambient temperature can occur together with high humidity conditions. In such conditions the ERHQ models may experience problems with severe ice build up on the aircooled coil. In case such conditions are expected, the ERLQ must be installed instead. These models contain countermeasures (insulation, bottom plate heater,...) to prevent freeze up.

NOTE



- An ERLQ0*BA outdoor unit can only be connected to an EKHBH/X008BA indoor unit (bottom plate heater at outdoor unit has to be controlled by indoor unit).
- An ERHQ0*BA outdoor unit can be connected to an EKHBH/X008BA indoor unit or to an EKHBH/X008AA indoor unit (if a bottom plate heater kit is required, see "Possible options" on page 3).

ACCESSORIES

- Accessories supplied with the outdoor unit:

Installation manual	1x	
Fluorinated greenhouse gases label	1x	
Multilingual fluorinated greenhouse gases label	1x	

- Possible options

	Bottom plate heater	Drain socket
	ERHQ_V3	Optional kit ⁽¹⁾
	ERLQ_V3	Standard
		Optional kit ⁽¹⁾
		Not allowed

(1) Combination of both options is not allowed.

	EKBPHT08	EKBPHT08BA
EKHBH/X008AA	Possible	Not allowed
EKHBH/X008BA	Possible	Possible

INSTALLATION GUIDELINES

Precautions for selecting the location



WARNING

- Make sure to provide for adequate measures in order to prevent that the outdoor unit be used as a shelter by small animals.
- Small animals making contact with electrical parts can cause malfunctions, smoke or fire. Please instruct the customer to keep the area around the unit clean.

- The equipment is not intended for use in a potentially explosive atmosphere.
- Choose a place solid enough to bear the weight and vibration of the unit, where the operation noise will not be amplified.
- Choose a location where the hot air discharged from the unit or the operation noise will not cause a nuisance to the neighbours of the user.

- Avoid places near a bedroom and the like, so that the operation noise will cause no trouble.
- There must be sufficient space for carrying the unit into and out of the site.
- There must be sufficient space for air passage and no obstructions around the air inlet and the air outlet.
- The site must be free from the possibility of flammable gas leakage in a nearby place.
- Locate the unit so that the noise and the discharged hot air will not annoy the neighbours.
- Install units, power cords and inter-unit cables at least 3 m away from television and radio sets. This is to prevent interference to images and sounds.
- Depending on radio wave conditions, electromagnetic interference may still occur even if installed more than 3 m away.
- In coastal areas or other places with salty atmosphere of sulfate gas, corrosion may shorten the life of the outdoor unit.
- Since drain flows out of the outdoor unit, do not place anything under the unit which must be kept away from moisture.

- 1 Select an installation site where the following conditions are satisfied and that meets with your customer's approval.

- Places which are well-ventilated.
- Places where the unit does not bother next-door neighbours.
- Safe places which can withstand the unit's weight and vibration and where the unit can be installed level.
- Places where there is no possibility of flammable gas or product leak.
- The equipment is not intended for use in a potentially explosive atmosphere.
- Places where servicing space can be well ensured.
- Places where the indoor and outdoor units' piping and wiring lengths come within the allowable ranges.
- Places where water leaking from the unit cannot cause damage to the location (e.g. in case of a blocked drain pipe).
- Places where the rain can be avoided as much as possible.
- Do not install the unit in places often used as work place. In case of construction works (e.g. grinding works) where a lot of dust is created, the unit must be covered.
- Do not place any objects or equipment on top of the unit (top plate).
- Do not climb, sit or stand on top of the unit,
- Be sure that sufficient precautions are taken, in accordance with relevant local and national regulations, in case of refrigerant leakage.

- 2 When installing the unit in a place exposed to strong wind, pay special attention to the following.

Strong winds of 5 m/sec or more blowing against the outdoor unit's air outlet causes short circuit (suction of discharge air), and this may have the following consequences:

- Deterioration of the operational capacity.
- Frequent frost acceleration in heating operation.
- Disruption of operation due to rise of high pressure.
- When a strong wind blows continuously on the face of the unit, the fan can start rotating very fast until it breaks. Refer to the figures for installation of this unit in a place where the wind direction can be foreseen.

- 3 Prepare a water drainage channel around the foundation, to drain waste water from around the unit.
- 4 If the water drainage of the unit is not easy, please build up the unit on a foundation of concrete blocks, etc. (the height of the foundation should be maximum 150 mm).
- 5 If you install the unit on a frame, please install a waterproof plate within 150 mm of the underside of the unit in order to prevent the invasion of water from the lower direction.

- 6 When installing the unit in a place frequently exposed to snow, pay special attention to elevate the foundation as high as possible.
- 7 If you install the unit on a building frame, please install a waterproof plate (field supply) (within 150 mm of the underside of the unit) or use a drain kit (refer to combination table in "Possible options" on page 3) in order to avoid the drainwater dripping. (See figure).

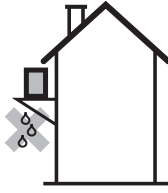

NOTE Units cannot be installed hanging from ceiling or stacked.

Selecting a location in cold climates

CAUTION

When operating the outdoor unit in a low outdoor ambient temperature, be sure to follow the instructions described below.

- To prevent exposure to wind, install the outdoor unit with its suction side facing the wall.
- Never install the outdoor unit at a site where the suction side may be exposed directly to wind.
- To prevent exposure to wind, install a baffle plate on the air discharge side of the outdoor unit.
- In heavy snowfall areas it is very important to select an installation site where the snow will not affect the unit. If lateral snowfall is possible, make sure that the heat exchanger coil is not affected by the snow (if necessary construct a lateral canopy).



Construct a large canopy.

Construct a pedestal.

Install the unit high enough off the ground to prevent burying in snow.

Refrigerant piping specifications

CAUTION

- Piping and other pressure containing parts shall comply with the applicable national and international regulations and shall be suitable for refrigerant. Use phosphoric acid deoxidised seamless copper for refrigerant.
- Installation shall be done by a licensed refrigerant technician, the choice of materials and installation shall comply with national and international regulations. In Europe the EN378 is the application standard that shall be used.

To persons in charge of piping work:

- Be sure to open the stop valve after piping installing and vacuuming is complete. (Running the system with the valve closed may break the compressor.)
- It is forbidden to discharge refrigerant into the atmosphere. Collect the refrigerant in accordance with the freon collection and destruction law.

Refrigerant piping specifications

Maximum allowable piping length between outdoor unit and indoor unit	30 m
Minimum required piping length between outdoor unit and indoor unit	3 m
Maximum allowable height difference between outdoor unit and indoor unit	20 m
Additional refrigerant required for refrigerant pipe exceeding 10 m in length	20 g/m
Gas pipe - outer diameter	15.9 mm (5/8")
Liquid pipe - outer diameter	6.4 mm (1/4")

Installing near a wall or obstacle

- Where a wall or other obstacle is in the path of the outdoor unit air intake or exhaust airflow, follow the installation guidelines below.
- For any of the installation patterns below, the wall height on the exhaust side should be 1200 mm or less.

Wall facing one side (unit: mm)

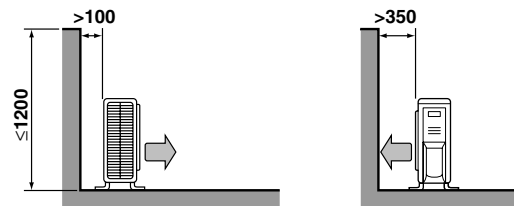

Walls facing two sides (unit: mm)

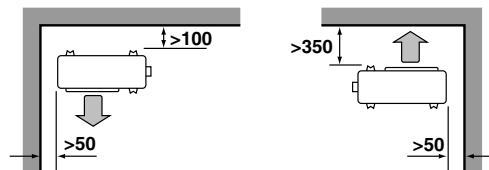

Walls facing three sides (unit: mm)

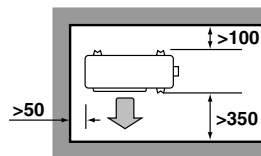

Outdoor unit installation drawing

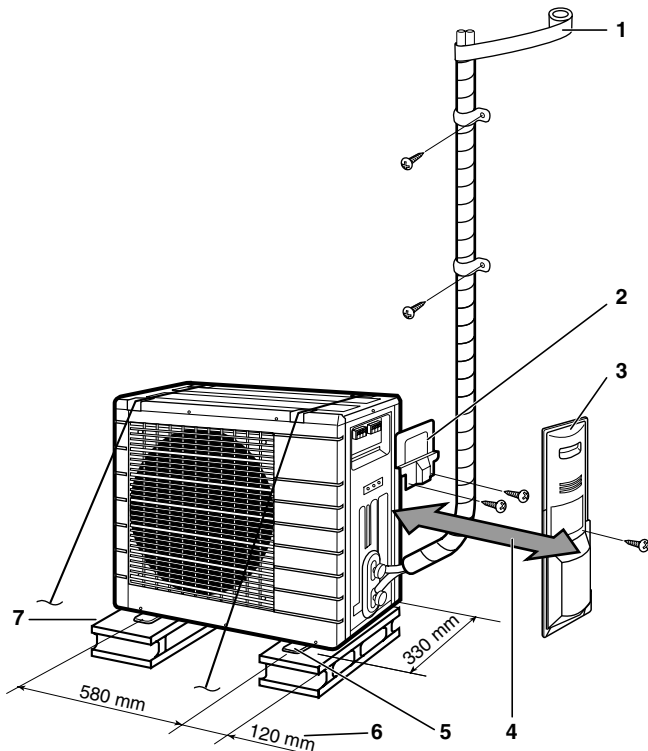

- 1 Wrap the insulation pipe with finishing tape from bottom to top.
- 2 Service cover
- 3 Stop valve cover
- 4 250 mm from wall. Allow space for piping and electrical servicing.
- 5 If there is danger of the unit falling or overturning, fix the unit with foundation bolts, or with wire or other means.
- 6 Distance from the outer side of the stop valve cover
- 7 If the location does not have good drainage, place the unit on block bases. Adjust foot height until the unit is levelled. Failure to do so may result in water leakage or accumulation.

INSTALLATION PROCEDURE

Mounting the outdoor unit

When installing the outdoor unit, please refer to "Installation guidelines" on page 3 to select an appropriate location.

- 1 Check the strength and level of the installation ground so that the unit will not cause any operating vibration or noise after installation.
- 2 Prepare 4 sets of M8 or M10 foundation bolts, nuts and washers each (field supply).
- 3 Fix the unit securely by means of the foundation bolts in accordance with the foundation drawing. It is best to screw in the foundation bolts until their length remains 20 mm above the foundation surface.

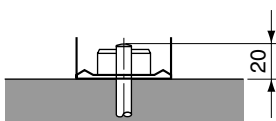

Drain work

Check in the combination table under "Possible options" on page 3 whether drain work is allowed. In case drain work on your unit is allowed and the installation site requires drain work, then follow the guidelines below.

- Drain kits for drainage are available as option.
- If drain work from the outdoor unit causes trouble (for example, if the drain water may splash on people) provide the drain piping using a drain socket (optional).
- Make sure the drain works properly.

NOTE



If drain holes of the outdoor unit are covered by a mounting base or by floor surface, raise the unit in order to provide a free space of more than 100 mm under the outdoor unit.

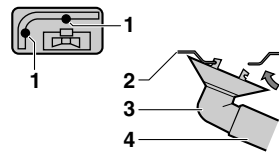
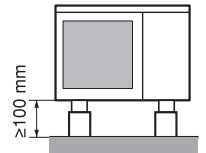

- 1 Drain water holes
- 2 Bottom frame
- 3 Drain socket (optional)
- 4 Hose (field supply, inner diameter 16 mm)

Flaring the pipe end

To flare each pipe end, follow the procedure below:

- 1 Cut the pipe end with a pipe cutter.
- 2 Remove burrs with the cut surface facing downward so that the chips do not enter the pipe.

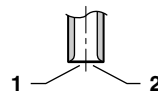

- 1 Cut exactly at right angles.
- 2 Remove burrs

- 3 Remove the flare nut from the stop valve and put the flare nut on the pipe.
- 4 Flare the pipe. Set exactly at the position shown below.

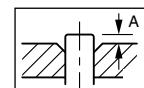

Conventional flare tool		
Flare tool for R410A (clutch type)	Clutch type (Ridgid-type)	Wing nut type (Imperial-type)
A	0~0.5 mm	1.0~1.5 mm
		1.5~2.0 mm

- 5 Check that the flaring is properly made.

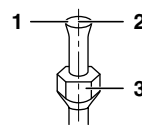

- 1 Flare's inner surface must be flaw-free.
- 2 The pipe end must be evenly flared in a perfect circle.
- 3 Make sure that the flare nut is fitted.

Connecting the refrigerant piping to the outdoor unit

! All field piping must be installed by a licensed refrigeration technician and must comply with relevant local and national regulations.

CAUTION

- Do not use mineral oil on flared part. Mineral oil getting into the system would reduce the lifetime of the units.
 - Never use piping which has been used for previous installations. Only use parts which are delivered with the unit.
 - Do never install a drier to this R410A unit in order to guarantee its lifetime. The drying material may dissolve and damage the system.
 - Incomplete flaring may cause refrigerant gas leakage.
- 1 When connecting the flare nut, coat the flare inner surface with ether oil or with ester oil and initially tighten 3 or 4 turns by hand before tightening firmly.

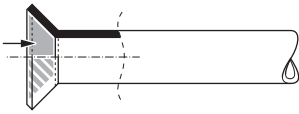

- 2 When loosening a flare nut, always use two wrenches together. When connecting the piping, always use a spanner and torque wrench together to tighten the flare nut to prevent nut cracking and leaks.

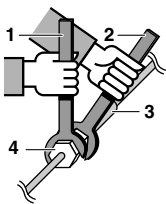

- 1 Torque wrench
- 2 Spanner
- 3 Piping union
- 4 Flare nut

Flare nut	Flare nut tightening torque
Ø6.4 mm (1/4")	15~17 N·m
Ø15.9 mm (5/8")	63~75 N·m

Valve cap tightening torque	
Valve cap	Gas pipe
Ø6.4 mm (1/4")	21.6~27.4 N·m
Ø15.9 mm (5/8")	44.1~53.9 N·m

Service port cap tightening torque
10.8~14.7 N·m

Refrigerant piping work

Pipe handling guidelines

- Protect the open end of the pipe against dust and moisture.
- All pipe bends should be as gentle as possible. Use a pipe bender for bending. Bending radius should be 30 to 40 mm or larger.

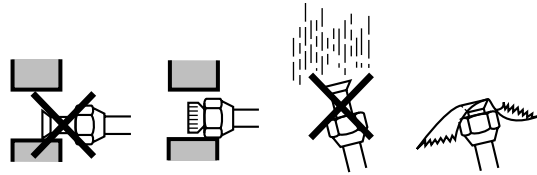

Selection of copper and heat insulation materials

When using commercial copper pipes and fittings, observe the following:

- Insulation material: polyethylene foam
Heat transfer rate: 0.041 to 0.052 W/mK (0.035 to 0.045 kcal/mh°C)
Refrigerant gas pipe's surface temperature reaches 110°C max. Choose heat insulation materials that will withstand this temperature.
- Be sure to insulate both the gas and liquid piping and to provide insulation dimensions as below.

Pipe size		Pipe insulation	
Outer diameter	Thickness	Inner diameter	Thickness
6.4 mm (1/4")	0.8 mm	8-10 mm	≥10 mm
15.9 mm (5/8")	1.0 mm	16-20 mm	≥13 mm

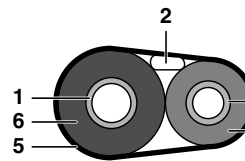

- 1 Gas pipe
- 2 Inter-unit wiring
- 3 Liquid pipe
- 4 Liquid pipe insulation
- 5 Finishing tape
- 6 Gas pipe insulation

- Use separate thermal insulation pipes for gas and liquid refrigerant pipes.

Purging air and checking gas leakage

When all piping work is completed and the outdoor unit is connected to the indoor unit, it is necessary to purge the air and check for gas leakage.



WARNING

- Do not mix any substance other than the specified refrigerant (R410A) into the refrigeration cycle.
- When refrigerant gas leaks occur, ventilate the room as soon and as much as possible.
- R410A, as well as other refrigerants, should always be recovered and never be released directly into the environment.



CAUTION

- Use a vacuum pump for R410A exclusively. Using the same vacuum pump for different refrigerants may damage the vacuum pump or the unit.
- If using additional refrigerant, perform air purging from the refrigerant pipes and indoor unit using a vacuum pump, then charge additional refrigerant.
- Use a hexagonal wrench (4 mm) to operate the stop valve rod.

- All refrigerant pipe joints should be tightened with a torque wrench at the specified tightening torque. See "Connecting the refrigerant piping to the outdoor unit" on page 6 for details.

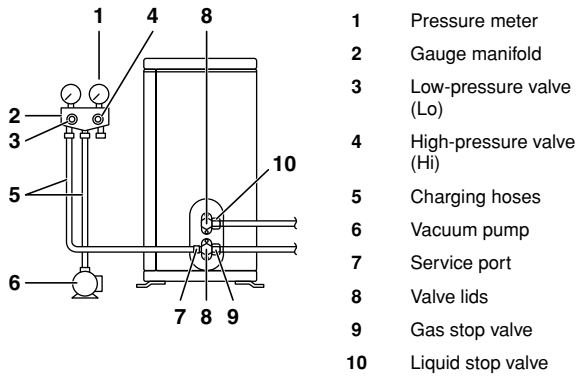

- 1 Connect the projection side (on which the worm pin is pressed) of the charging hose coming from the gauge manifold to the gas stop valve's service port.
- 2 Fully open the gauge manifold's low-pressure valve (Lo) and completely close its high-pressure valve (Hi). The high-pressure valve subsequently requires no operation.
- 3 Apply vacuum pumping. Check that the compound pressure gauge reads -0.1 MPa (-760 mm Hg).

Pipe length		
	≤ 15 m	> 15 m
Run time	≥ 10 minutes	≥ 15 minutes
- 4 Close the gauge manifold's low-pressure valve (Lo) and stop the vacuum pump.
Leave as is for 4-5 minutes and make sure that the coupling meter needle does not go back.

NOTE If the meter needle does go back, this may indicate presence of moisture or leaking from connecting parts. Repeat steps 2 through 4 after checking all connecting parts and slightly loosening and retightening the nuts.
- 5 Remove the covers from the liquid stop valve and gas stop valve.
- 6 Turn the liquid stop valve's rod 90 degrees counterclockwise with a hexagonal wrench to open the valve.
Close it after 5 seconds, and check for gas leakage.
Using soapy water, check for gas leakage from the indoor unit's flare and the outdoor unit's flare and the valve rods.
After the check is complete, wipe all soapy water off.
- 7 Disconnect the charging hose from the gas stop valve's service port, then fully open the liquid and gas stop valves.
Do not attempt to turn the valve rod beyond its stop.
- 8 Tighten the valve lids and service port caps for the liquid and gas stop valves with a torque wrench at the specified torques. See "Connecting the refrigerant piping to the outdoor unit" on page 6 for details.

Charging refrigerant

This outdoor unit is factory charged.

Important information regarding the refrigerant used

This product contains fluorinated greenhouse gases covered by the Kyoto Protocol. Do not vent gases into the atmosphere.

Refrigerant type: R410A

GWP⁽¹⁾ value: 1975

(1) GWP = global warming potential

Please fill in with indelible ink,

- ① the factory refrigerant charge of the product,
- ② the additional refrigerant amount charged in the field and
- ①+② the total refrigerant charge

on the fluorinated greenhouse gases label supplied with the product.

The filled out label must be adhered on the inside of the product and in the proximity of the product charging port (e.g. on the inside of the service cover).

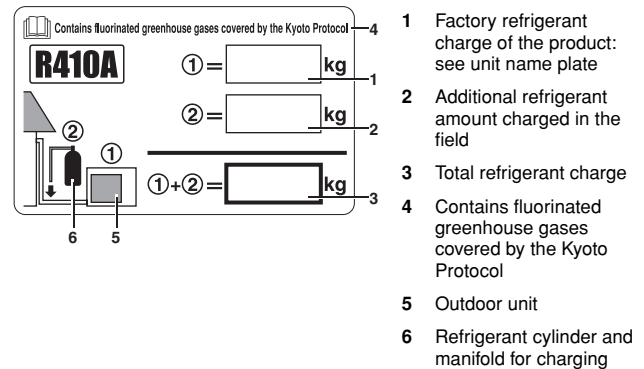

- NOTE** National implementation of EU regulation on certain fluorinated greenhouse gases may require to provide the appropriate official national language on the unit. Therefore, an additional multilingual fluorinated greenhouse gases label is supplied with the unit.
- Sticking instructions are illustrated on the backside of that label.

To avoid compressor breakdown. Do not charge the refrigerant more than the specified amount.

This outdoor unit is factory charged with refrigerant and depending on pipe sizes and pipe lengths some systems require additional charging of refrigerant.

Re-charging

In case re-charging is required, refer to the nameplate of the unit. The nameplate states the type of refrigerant and necessary amount.

Charging additional refrigerant

If the total length of refrigerant piping exceeds 10 m in length, additionally charge with 20 g of refrigerant (R410A) for each additional meter of piping.

Determine the weight of refrigerant to be charged additionally and fill in the amount in the service sticker on the rear side of the stop valve cover.

Precautions when adding R410A

- Be sure to charge the specified amount of refrigerant in liquid state to the liquid pipe.
Since this refrigerant is a mixed refrigerant, adding it in gas form may cause the refrigerant composition to change, preventing normal operation.
- Before charging, check whether the refrigerant cylinder is equipped with a siphon tube or not (the cylinder should be marked with "liquid filling siphon attached" or something similar).

Charge the liquid refrigerant with the cylinder in upright position.

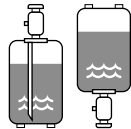

Charge the liquid refrigerant with the cylinder in up-side-down position.

- Be sure to use tools exclusively for R410A to ensure required pressure resistance and to prevent foreign materials from mixing into the system.

Wiring



DANGER

- Before obtaining access to terminal devices, all supply circuits must be interrupted.
- High voltage
To avoid electrical shock, make sure to disconnect the power supply 1 minute or more before servicing the electrical parts. Even after 1 minute, always measure the voltage at the terminals of main circuit capacitors or electrical parts and, before touching, make sure that those voltages are 50 V DC or less.



To persons in charge of electrical wiring work:

Do not operate the unit until the refrigerant piping is complete. (Running it before the piping is ready will break the compressor.)



WARNING

- All components procured on the site and all electric construction shall comply with the applicable local and national regulations.
- Use only copper wires.
- Never squeeze bundled cables into a unit.
- Fix cables so that cables do not make contact with the pipes (especially on high pressure side).
- Secure the electrical wiring with cable ties as shown in the figure below so that it does not come in contact with the piping, particularly on the high-pressure side. Make sure no external pressure is applied to the terminal connectors.
- Be sure to install the required fuses.
- All wiring must be performed by an authorized electrician.
- The power supply cable and circuit breaker must be selected in accordance with local and national regulations.
- Do not use tapped wires, stranded conductor wires (see caution 1 under "Notes to observe" on page 9), extension cords, or connections from a star system, as they may cause overheating, electrical shock or fire.
- Do not use locally purchased electrical parts inside the product and do not branch the power for the heater tape, etc., from the terminal block. Doing this may cause electrical shock or fire.
- Be sure to install an earth leakage circuit breaker. Failure to do so may cause electrical shock.
This unit uses an inverter, which means that an earth leakage circuit breaker capable of handling high harmonics needs to be used in order to prevent malfunctioning of the earth leakage circuit breaker itself.
- A main switch or other means for disconnection, having a contact separation in all poles, must be incorporated in the fixed wiring in accordance with relevant local and national legislation.



DANGER

Do not turn ON the safety breaker until all work is completed.

Equipment complying with EN/IEC 61000-3-12⁽¹⁾

(1) European/International Technical Standard setting the limits for harmonic currents produced by equipment connected to public low-voltage systems with input current >16 A and ≤75 A per phase.

Procedure

- Strip the insulation from the wire (20 mm).
- Connect the connection wires between the indoor and outdoor units **so that the terminal numbers match** (see wiring diagram below). Tighten the terminal screws securely. We recommend a flathead screwdriver to tighten the screws. See also caution 2 under "Notes to observe" on page 9 for wiring guidelines.

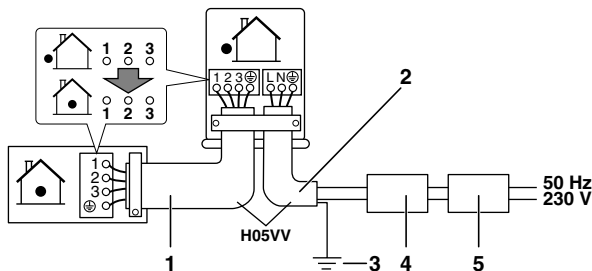

- Interconnection between indoor unit and outdoor unit : when wire length exceeds 10 m, use Ø2.5 mm wires instead of Ø1.5 mm wires.
- Power supply cable (refer to the unit nameplate for maximum running current)
- Earth
- Safety breaker
- Earth leakage circuit breaker

3 Earth terminal installation



WARNING

This unit must be earthed.

For earthing, follow the applicable local standard for electrical installations.

- Use the following method when installing single core wires.

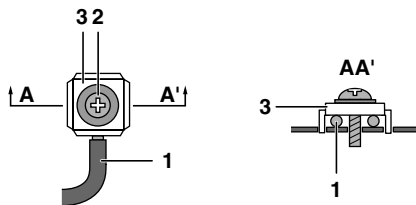

- Single core wire
- Screw
- Flat washer

- Use the following method when using round crimp-style terminals.

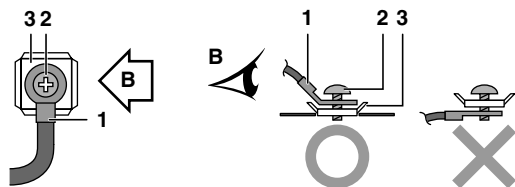

- Round crimp-style terminal
- Screw
- Flat washer

- Pull the connected wire and make sure that it does not disconnect. Then fix the wires in place in the wire clamp. See also "Notes to observe" on page 9.

Notes to observe

Observe the notes mentioned below when wiring to the power supply terminal board.

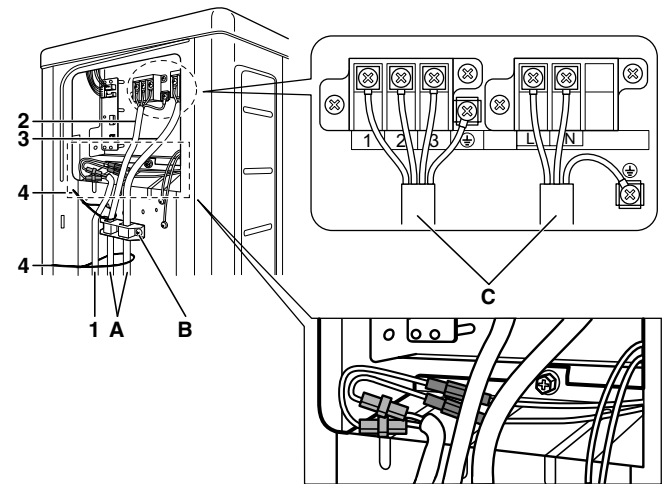

- Interconnection
- Power supply cable
- Bottom plate heater power supply cable
- Tie wrap

- Use the specified wire type and connect it securely (A).
- Firmly secure the wire clamp so that wire terminations do not receive external stress (B).
- Shape wires so that the service cover and stop valve cover fit securely (C).



CAUTION

- In case the use of stranded conductor wires is unavoidable for one reason or another, make sure to install round crimp-style terminals on the tip. Place the round crimp-style terminal on the wire up to the covered part and fasten the terminal with the appropriate tool.

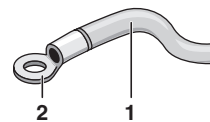

- Stranded conductor wire
- Round crimp-style terminal

- When connecting the connection wires to the terminal board using a single core wire, be sure to perform curling.

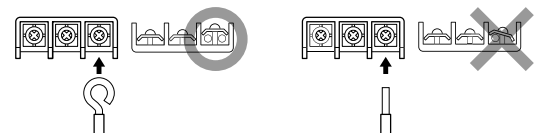

Not executing the connections properly may cause heat and fire.

Strip the wire at terminal block:



- Strip wire end to this point
- Excessive strip length may cause electrical shock or leakage.

TEST RUN AND FINAL CHECK

- NOTE**  Remark that during the first running period of the unit, required power input may be higher than stated on the nameplate of the unit. This phenomenon originates from the compressor that needs elapse of a 50 hours run in period before reaching smooth operation and stable power consumption.

Trial operation and testing

- 1 Measure the voltage at the primary side of the safety breaker. Check that it is 230 V.
- 2 Carry out the test operation in accordance with the indoor installation manual and operation manual to ensure that all functions and parts are working properly.

- NOTE** 
- The unit requires a small amount of power in its standby mode. If the system is not to be used for some time after installation, shut off the circuit breaker to eliminate unnecessary power consumption.
 - If the circuit breaker trips to shut off the power to the outdoor unit, the system will restore the original operation mode when the power supply is restored.

Items to check

Check	Symptom
<input type="checkbox"/> Outdoor unit is installed properly on solid base.	Fall, vibration, noise
<input type="checkbox"/> No refrigerant gas leaks.	Incomplete cooling/heating function
<input type="checkbox"/> Refrigerant gas and liquid pipes are thermally insulated.	Water leakage
<input type="checkbox"/> System is properly earthed.	Electrical leakage
<input type="checkbox"/> The specified wires are used for interconnecting wire connections.	Inoperative or burn damage
<input type="checkbox"/> Outdoor unit air intake and exhaust is free of obstructions. Stop valves are opened.	Incomplete cooling/heating function

- NOTE**  Have the customer actually operate the unit while looking at the manual included with the indoor unit. Instruct the customer how to operate the unit correctly.

PUMP DOWN OPERATION

In order to protect the environment, be sure to pump down when relocating or disposing of the unit. The pump down operation will extract all refrigerant from the piping into the outdoor unit.

Pump down procedure

- 1 Remove the valve lid from liquid stop valve and gas stop valve.
- 2 Carry out the forced cooling operation.
- 3 After 5 to 10 minutes (after only 1 or 2 minutes in case of very low ambient temperatures (<-10°C)), close the liquid stop valve with a hexagonal wrench.
- 4 After 2-3 minutes, close the gas stop valve and stop forced cooling operation.

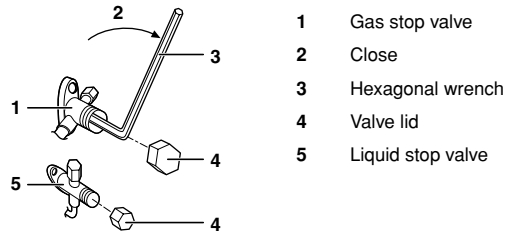

Forced cooling operation

- 1 Press the forced operation switch SW1 to begin forced cooling.
- 2 Press the forced operation switch SW1 again to stop forced cooling.

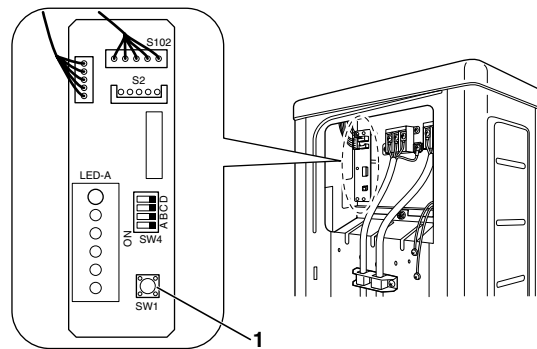

- NOTE**  Take care that while running forced cooling operation the water temperature remains higher than 5°C (see temperature read out of the indoor unit). You can achieve this, for example, by activating all fans of the fan coil units.

MAINTENANCE AND SERVICING

Service precautions



WARNING: ELECTRIC SHOCK



Caution when performing service to inverter equipment



DANGER

- Do not touch live parts for 10 minutes after the power supply is turned off because of high voltage risk.
 - Make sure that the power supply is turned off before performing the maintenance work. The heater of the compressor may operate even in stop mode.
-
- Please note that some sections of the electric component box are extremely hot.
 - In order to prevent damage to the PCB, first eliminate static electricity by touching a metal part (e.g. stop valve) with your hand. Then pull out the connector.
 - After measuring the residual voltage, pull out the outdoor fan connector.
 - Make sure you do not touch a conductive section.
 - The outdoor fan may rotate due to strong backblow wind, causing the capacitor to charge. This may result in an electric shock.

After maintenance, make sure the outdoor fan connector is connected again. Otherwise, the unit may break down.



Play it safe!

Touch a metal part by hand (such as the stop valve) in order to eliminate static electricity and to protect the PCB before performing service.

Service mode operation

Refer to the service manual to carry out any service mode operation.

DISPOSAL REQUIREMENTS

Dismantling of the unit, treatment of the refrigerant, of oil and of other parts must be done in accordance with relevant local and national legislation.

UNIT SPECIFICATIONS

Technical specifications

Casing material	Painted galvanised steel
Dimensions h x w x d (mm)	735 x 825 x 300
Weight (kg)	57
Operation range	
• cooling (min./max.) (°C)	10/43
• heating (min./max.) (°C)	-15/25
• domestic hot water (min./max.) (°C)	-15/35
Refrigerant oil	Daphne FVC68D
Piping connection	
• liquid (mm)	6.4
• gas (mm)	15.9

Electrical specifications

Phase	1~
Frequency (Hz)	50
Voltage range	
• minimum (V)	207
• maximum (V)	253



4PW54246-1 A 000000N

Copyright © Daikin

DAIKIN EUROPE N.V.

Zandvoordestraat 300, B-8400 Oostende, Belgium

4PW54246-1A