

DAIKIN

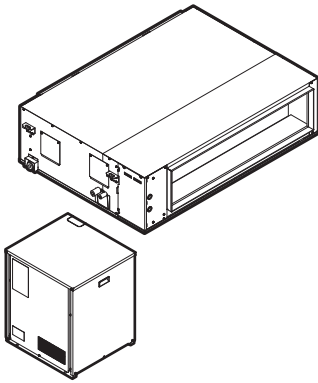

Installer and user reference guide

VRV IV heat pump for indoor installation



RKXYQ5T7Y1B
RDXYQ5T7V1B*

RKXYQ8T7Y1B
RDXYQ8T7V1B

Installer and user reference guide
VRV IV heat pump for indoor installation

English

Table of Contents

Table of Contents

1	General safety precautions	3
1.1	About the documentation	3
1.1.1	Meaning of warnings and symbols	3
1.2	For the user	4
1.3	For the installer	4
1.3.1	General	4
1.3.2	Installation site	5
1.3.3	Refrigerant	5
1.3.4	Brine	6
1.3.5	Water	6
1.3.6	Electrical	6
2	About the documentation	7
2.1	About this document	7
For the installer		7
3	About the box	7
3.1	Overview: About the box	7
3.2	Compressor unit	8
3.2.1	To unpack the compressor unit	8
3.2.2	To handle the compressor unit	8
3.2.3	To remove the accessories from the compressor unit	8
3.2.4	To remove the transportation stay	8
3.2.5	To remove the transportation EPS	8
3.3	Heat exchanger unit	9
3.3.1	To unpack the heat exchanger unit	9
3.3.2	To handle the heat exchanger unit	9
3.3.3	To remove the accessories from the heat exchanger unit	9
3.3.4	To remove the transportation sheet	9
4	About the units and options	9
4.1	Overview: About the units and options	9
4.2	Identification	9
4.2.1	Identification label: Compressor unit	10
4.2.2	Identification label: Heat exchanger unit	10
4.3	About the compressor unit and heat exchanger unit	10
4.4	System layout	10
4.5	Combining units and options	10
4.5.1	About combining units and options	10
4.5.2	Possible combinations of indoor units	11
4.5.3	Possible options for the compressor unit and heat exchanger unit	11
5	Preparation	12
5.1	Overview: Preparation	12
5.2	Preparing installation site	12
5.2.1	Installation site requirements of the compressor unit	12
5.2.2	Installation site requirements of the heat exchanger unit	13
5.2.3	Securing safety against refrigerant leaks	13
5.3	Preparing refrigerant piping	14
5.3.1	Refrigerant piping requirements	14
5.3.2	Refrigerant piping material	14
5.3.3	To select the piping size	15
5.3.4	To select refrigerant branch kits	15
5.3.5	Refrigerant piping length and height difference	16
5.4	Preparing electrical wiring	16
5.4.1	About electrical compliance	16
5.4.2	Safety device requirements	16
6	Installation	17
6.1	Overview: Installation	17
6.2	Opening the units	17

6.2.1	About opening the units	17
6.2.2	To open the compressor unit	17
6.2.3	To open the switch box cover of the heat exchanger unit	17
6.3	Mounting the compressor unit	18
6.3.1	Precautions when mounting the compressor unit	18
6.3.2	Guidelines when installing the compressor unit	18
6.4	Mounting the heat exchanger unit	18
6.4.1	Precautions when mounting the heat exchanger unit	18
6.4.2	Guidelines when installing the heat exchanger unit	18
6.4.3	Guidelines when installing the ducting	18
6.4.4	Guidelines when installing the drain piping	19
6.5	Connecting the refrigerant piping	20
6.5.1	About connecting the refrigerant piping	20
6.5.2	Precautions when connecting the refrigerant piping	20
6.5.3	Pipe bending guidelines	20
6.5.4	To braze the pipe end	20
6.5.5	Using the stop valve and service port	21
6.5.6	To remove the pinched pipes	21
6.5.7	To connect the refrigerant piping to the compressor unit	22
6.5.8	To connect the refrigerant piping to the heat exchanger unit	23
6.5.9	To connect the refrigerant branching kit	23
6.6	Checking the refrigerant piping	24
6.6.1	About checking the refrigerant piping	24
6.6.2	Checking refrigerant piping: General guidelines	24
6.6.3	Checking refrigerant piping: Setup	24
6.6.4	To perform a leak test	25
6.6.5	To perform vacuum drying	25
6.7	To insulate the refrigerant piping	25
6.8	Charging refrigerant	26
6.8.1	About charging refrigerant	26
6.8.2	Precautions when charging refrigerant	26
6.8.3	To determine the additional refrigerant amount	26
6.8.4	To charge refrigerant	26
6.8.5	Error codes when charging refrigerant	28
6.8.6	To fix the fluorinated greenhouse gases label	28
6.9	Connecting the electrical wiring	28
6.9.1	About connecting the electrical wiring	28
6.9.2	Precautions when connecting electrical wiring	29
6.9.3	Guidelines when connecting the electrical wiring	30
6.9.4	To connect the electrical wiring on the compressor unit	30
6.9.5	To connect the electrical wiring on the heat exchanger unit	31
6.10	Finishing the compressor unit installation	32
6.10.1	To finish the transmission wiring	32
6.10.2	To close the compressor unit	32
6.11	Finishing the heat exchanger unit installation	32
6.11.1	To close the heat exchanger unit	32
7	Configuration	32
7.1	Overview: Configuration	32
7.2	Making field settings	32
7.2.1	About making field settings	32
7.2.2	To access the field setting components	33
7.2.3	Field setting components	33
7.2.4	To access mode 1 or 2	34
7.2.5	To use mode 1 (and default situation)	34
7.2.6	To use mode 2	35
7.2.7	Mode 1 (and default situation): Monitoring settings	35
7.2.8	Mode 2: Field settings	37
7.2.9	To connect the PC configurator to the compressor unit	40
7.3	Energy saving and optimum operation	40
7.3.1	Available main operation methods	40
7.3.2	Available comfort settings	40
7.3.3	Example: Automatic mode during cooling	41
7.3.4	Example: Automatic mode during heating	42

8 Commissioning	42	19 Maintenance and service	56
8.1 Overview: Commissioning.....	42	19.1 Maintenance after a long stop period.....	57
8.2 Precautions when commissioning.....	42	19.2 Maintenance before a long stop period.....	57
8.3 Checklist before commissioning.....	43	19.3 About the refrigerant.....	57
8.4 Checklist during commissioning.....	43	19.4 After-sales service and warranty.....	57
8.4.1 About test run.....	43	19.4.1 Warranty period.....	57
8.4.2 To perform a test run (7-LEDs display).....	44	19.4.2 Recommended maintenance and inspection.....	57
8.4.3 To perform a test run (7-segments display).....	44	19.4.3 Recommended maintenance and inspection cycles.....	58
8.4.4 Correcting after abnormal completion of the test run..	44	19.4.4 Shortened maintenance and replacement cycles.....	58
8.4.5 Operating the unit.....	45		
9 Hand-over to the user	45	20 Troubleshooting	58
10 Maintenance and service	45	20.1 Error codes: Overview.....	59
10.1 Overview: Maintenance and service.....	45	20.2 Symptoms that are NOT system malfunctions.....	60
10.2 Maintenance safety precautions.....	45	20.2.1 Symptom: The system does not operate.....	60
10.2.1 To prevent electrical hazards.....	45	20.2.2 Symptom: Cool/Heat cannot be changed over.....	60
10.3 Checklist for yearly maintenance of the heat exchanger unit....	45	20.2.3 Symptom: Fan operation is possible, but cooling and heating do not work.....	60
10.4 About service mode operation.....	45	20.2.4 Symptom: The fan strength does not correspond to the setting.....	60
10.4.1 To use vacuum mode.....	45	20.2.5 Symptom: The fan direction does not correspond to the setting.....	60
10.4.2 To recover refrigerant.....	46	20.2.6 Symptom: White mist comes out of a unit (Indoor unit).....	60
11 Troubleshooting	46	20.2.7 Symptom: White mist comes out of a unit (Indoor unit, heat exchanger unit).....	60
11.1 Overview: Troubleshooting.....	46	20.2.8 Symptom: The user interface display reads "U4" or "U5" and stops, but then restarts after a few minutes..	60
11.2 Precautions when troubleshooting.....	46	20.2.9 Symptom: Noise of air conditioners (Indoor unit, heat exchanger unit).....	60
11.3 Solving problems based on error codes.....	46	20.2.10 Symptom: Noise of air conditioners (Indoor unit, compressor unit, heat exchanger unit).....	60
11.3.1 Error codes: Overview.....	46	20.2.11 Symptom: Noise of air conditioners (compressor unit, heat exchanger unit).....	60
12 Disposal	50	20.2.12 Symptom: Dust comes out of the heat exchanger unit.....	60
13 Technical data	50	20.2.13 Symptom: The units can give off odours.....	60
13.1 Piping diagram: Compressor unit and heat exchanger unit.....	50	20.2.14 Symptom: The heat exchanger unit fan does not spin.....	61
13.2 Wiring diagram: Compressor unit.....	51	20.2.15 Symptom: The display shows "88".....	61
13.3 Wiring diagram: Heat exchanger unit.....	52	20.2.16 Symptom: The compressor in the compressor unit does not stop after a short heating operation.....	61
		20.2.17 Symptom: The inside of a compressor unit is warm even when the unit has stopped.....	61
		20.2.18 Symptom: Hot air can be felt when the indoor unit is stopped.....	61
		21 Relocation	61
		22 Disposal	61
		23 Glossary	61
For the user	52		
14 About the system	52		
14.1 System layout.....	52		
15 User interface	53		
16 Before operation	53		
17 Operation	53		
17.1 Operation range.....	53		
17.2 Operating the system.....	53		
17.2.1 About operating the system.....	53		
17.2.2 About cooling, heating, fan only, and automatic operation.....	53		
17.2.3 About the heating operation.....	53		
17.2.4 To operate the system (WITHOUT cool/heat changeover remote control switch).....	54		
17.2.5 To operate the system (WITH cool/heat changeover remote control switch).....	54		
17.3 Using the dry program.....	54		
17.3.1 About the dry program.....	54		
17.3.2 To use the dry program (WITHOUT cool/heat changeover remote control switch).....	54		
17.3.3 To use the dry program (WITH cool/heat changeover remote control switch).....	55		
17.4 Adjusting the air flow direction.....	55		
17.4.1 About the air flow flap.....	55		
17.5 Setting the master user interface.....	55		
17.5.1 About setting the master user interface.....	55		
17.5.2 To designate the master user interface (VRV DX).....	55		
17.5.3 About control systems.....	56		
18 Energy saving and optimum operation	56		
18.1 Available main operation methods.....	56		
18.2 Available comfort settings.....	56		

1 General safety precautions

1.1 About the documentation

- The original documentation is written in English. All other languages are translations.
- The precautions described in this document cover very important topics, follow them carefully.
- The installation of the system, and all activities described in the installation manual and the installer reference guide must be performed by an authorized installer.









1.1.1 Meaning of warnings and symbols





DANGER

Indicates a situation that results in death or serious injury.

1 General safety precautions

	DANGER: RISK OF ELECTROCUTION Indicates a situation that could result in electrocution.
	DANGER: RISK OF BURNING Indicates a situation that could result in burning because of extreme hot or cold temperatures.
	DANGER: RISK OF EXPLOSION Indicates a situation that could result in explosion.
	WARNING Indicates a situation that could result in death or serious injury.
	WARNING: FLAMMABLE MATERIAL
	CAUTION Indicates a situation that could result in minor or moderate injury.
	NOTICE Indicates a situation that could result in equipment or property damage.
	INFORMATION Indicates useful tips or additional information.

Symbol	Explanation
	Before installation, read the installation and operation manual, and the wiring instruction sheet.
	Before performing maintenance and service tasks, read the service manual.
	For more information, see the installer and user reference guide.

1.2 For the user

- If you are not sure how to operate the unit, contact your installer.
- This appliance can be used by children aged from 8 years and above and persons with reduced physical, sensory or mental capabilities or lack of experience and knowledge if they have been given supervision or instruction concerning use of the appliance in a safe way and understand the hazards involved. Children shall not play with the appliance. Cleaning and user maintenance shall not be made by children without supervision.

	WARNING To prevent electric shocks or fire: <ul style="list-style-type: none"> ▪ Do NOT rinse the unit. ▪ Do NOT operate the unit with wet hands. ▪ Do NOT place any objects containing water on the unit.
---	---

	NOTICE <ul style="list-style-type: none"> ▪ Do NOT place any objects or equipment on top of the unit. ▪ Do NOT sit, climb or stand on the unit.
---	--

- Units are marked with the following symbol:



This means that electrical and electronic products may not be mixed with unsorted household waste. Do NOT try to dismantle the system yourself: the dismantling of the system, treatment of the refrigerant, of oil and of other parts must be done by an authorized installer and must comply with applicable legislation. Units must be treated at a specialized treatment facility for reuse, recycling and recovery. By ensuring this product is disposed of correctly, you will help to prevent potential negative consequences for the environment and human health. For more information, contact your installer or local authority.

- Batteries are marked with the following symbol:





This means that the batteries may not be mixed with unsorted household waste. If a chemical symbol is printed beneath the symbol, this chemical symbol means that the battery contains a heavy metal above a certain concentration. Possible chemical symbols are: Pb: lead (>0.004%). Waste batteries must be treated at a specialized treatment facility for reuse. By ensuring waste batteries are disposed of correctly, you will help to prevent potential negative consequences for the environment and human health.

1.3 For the installer

1.3.1 General

If you are not sure how to install or operate the unit, contact your dealer.

	NOTICE Improper installation or attachment of equipment or accessories could result in electric shock, short-circuit, leaks, fire or other damage to the equipment. Only use accessories, optional equipment and spare parts made or approved by Daikin.
---	--

	WARNING Make sure installation, testing and applied materials comply with applicable legislation (on top of the instructions described in the Daikin documentation).
---	--

	CAUTION Wear adequate personal protective equipment (protective gloves, safety glasses,...) when installing, maintaining or servicing the system.
---	---

	WARNING Tear apart and throw away plastic packaging bags so that nobody, especially children, can play with them. Possible risk: suffocation.
---	---

	DANGER: RISK OF BURNING <ul style="list-style-type: none"> ▪ Do NOT touch the refrigerant piping, water piping or internal parts during and immediately after operation. It could be too hot or too cold. Give it time to return to normal temperature. If you must touch it, wear protective gloves. ▪ Do NOT touch any accidental leaking refrigerant.
---	---



WARNING

Provide adequate measures to prevent that the unit can be used as a shelter by small animals. Small animals that make contact with electrical parts can cause malfunctions, smoke or fire.



CAUTION

Do NOT touch the air inlet or aluminum fins of the unit.



NOTICE

- Do NOT place any objects or equipment on top of the unit.
- Do NOT sit, climb or stand on the unit.



NOTICE

Works executed on the outdoor unit are best done under dry weather conditions to avoid water ingress.

In accordance with the applicable legislation, it might be necessary to provide a logbook with the product containing at least: information on maintenance, repair work, results of tests, stand-by periods,...

Also, at least, following information must be provided at an accessible place at the product:

- Instructions for shutting down the system in case of an emergency
- Name and address of fire department, police and hospital
- Name, address and day and night telephone numbers for obtaining service

In Europe, EN378 provides the necessary guidance for this logbook.

1.3.2 Installation site

- Provide sufficient space around the unit for servicing and air circulation.
- Make sure the installation site withstands the unit's weight and vibration.
- Make sure the area is well ventilated. Do NOT block any ventilation openings.
- Make sure the unit is level.

Do NOT install the unit in the following places:

- In potentially explosive atmospheres.
- In places where there is machinery that emits electromagnetic waves. Electromagnetic waves may disturb the control system, and cause malfunction of the equipment.
- In places where there is a risk of fire due to the leakage of flammable gases (example: thinner or gasoline), carbon fibre, ignitable dust.
- In places where corrosive gas (example: sulphurous acid gas) is produced. Corrosion of copper pipes or soldered parts may cause the refrigerant to leak.

1.3.3 Refrigerant

If applicable. See the installation manual or installer reference guide of your application for more information.



NOTICE

Make sure refrigerant piping installation complies with applicable legislation. In Europe, EN378 is the applicable standard.



NOTICE

Make sure the field piping and connections are not subjected to stress.



WARNING

During tests, NEVER pressurize the product with a pressure higher than the maximum allowable pressure (as indicated on the nameplate of the unit).



WARNING

Take sufficient precautions in case of refrigerant leakage. If refrigerant gas leaks, ventilate the area immediately. Possible risks:

- Excessive refrigerant concentrations in a closed room can lead to oxygen deficiency.
- Toxic gas may be produced if refrigerant gas comes into contact with fire.



DANGER: RISK OF EXPLOSION

Pump down – Refrigerant leakage. If you want to pump down the system, and there is a leakage in the refrigerant circuit:

- Do NOT use the unit's automatic pump down function, with which you can collect all refrigerant from the system into the outdoor unit. **Possible consequence:** Self-combustion and explosion of the compressor because of air going into the operating compressor.
- Use a separate recovery system so that the unit's compressor does NOT have to operate.



WARNING

Always recover the refrigerant. Do NOT release them directly into the environment. Use a vacuum pump to evacuate the installation.



NOTICE

After all the piping has been connected, make sure there is no gas leak. Use nitrogen to perform a gas leak detection.



NOTICE

- To avoid compressor breakdown, do NOT charge more than the specified amount of refrigerant.
- When the refrigerant system is to be opened, refrigerant must be treated according to the applicable legislation.



WARNING

Make sure there is no oxygen in the system. Refrigerant may only be charged after performing the leak test and the vacuum drying.

- In case re-charge is required, refer to the nameplate of the unit. It states the type of refrigerant and necessary amount.
- The unit is factory charged with refrigerant and depending on pipe sizes and pipe lengths some systems require additional charging of refrigerant.
- Only use tools exclusively for the refrigerant type used in the system, this to ensure pressure resistance and prevent foreign materials from entering into the system.
- Charge the liquid refrigerant as follows:

If	Then
A siphon tube is present (i.e., the cylinder is marked with "Liquid filling siphon attached")	Charge with the cylinder upright. 

1 General safety precautions

If	Then
A siphon tube is NOT present	Charge with the cylinder upside down. 

- Open refrigerant cylinders slowly.
- Charge the refrigerant in liquid form. Adding it in gas form may prevent normal operation.

CAUTION

When the refrigerant charging procedure is done or when pausing, close the valve of the refrigerant tank immediately. If the valve is not closed immediately, remaining pressure might charge additional refrigerant.
Possible consequence: Incorrect refrigerant amount.

1.3.4 Brine

If applicable. See the installation manual or installer reference guide of your application for more information.

WARNING

The selection of the brine MUST be in accordance with the applicable legislation.

WARNING

Take sufficient precautions in case of brine leakage. If brine leaks, ventilate the area immediately and contact your local dealer.

WARNING

The ambient temperature inside the unit can get much higher than that of the room, e.g. 70°C. In case of a brine leak, hot parts inside the unit can create a hazardous situation.

WARNING

The use and installation of the application MUST comply with the safety and environmental precautions specified in the applicable legislation.

1.3.5 Water

If applicable. See the installation manual or installer reference guide of your application for more information.

NOTICE

Make sure water quality complies with EU directive 98/83 EC.

1.3.6 Electrical



DANGER: RISK OF ELECTROCUTION

- Turn OFF all power supply before removing the switch box cover, connecting electrical wiring or touching electrical parts.
- Disconnect the power supply for more than 1 minute, and measure the voltage at the terminals of main circuit capacitors or electrical components before servicing. The voltage MUST be less than 50 V DC before you can touch electrical components. For the location of the terminals, see the wiring diagram.
- Do NOT touch electrical components with wet hands.
- Do NOT leave the unit unattended when the service cover is removed.



WARNING

If NOT factory installed, a main switch or other means for disconnection, having a contact separation in all poles providing full disconnection under overvoltage category III condition, shall be installed in the fixed wiring.



WARNING

- ONLY use copper wires.
- Make sure the field wiring complies with the applicable legislation.
- All field wiring must be performed in accordance with the wiring diagram supplied with the product.
- NEVER squeeze bundled cables and make sure they do not come in contact with the piping and sharp edges. Make sure no external pressure is applied to the terminal connections.
- Make sure to install earth wiring. Do NOT earth the unit to a utility pipe, surge absorber, or telephone earth. Incomplete earth may cause electrical shock.
- Make sure to use a dedicated power circuit. NEVER use a power supply shared by another appliance.
- Make sure to install the required fuses or circuit breakers.
- Make sure to install an earth leakage protector. Failure to do so may cause electric shock or fire.
- When installing the earth leakage protector, make sure it is compatible with the inverter (resistant to high frequency electric noise) to avoid unnecessary opening of the earth leakage protector.

**NOTICE**

Precautions when laying power wiring:

- Do not connect wiring of different thicknesses to the power terminal block (slack in the power wiring may cause abnormal heat).
- When connecting wiring which is the same thickness, do as shown in the figure below.



- For wiring, use the designated power wire and connect firmly, then secure to prevent outside pressure being exerted on the terminal board.
- Use an appropriate screwdriver for tightening the terminal screws. A screwdriver with a small head will damage the head and make proper tightening impossible.
- Over-tightening the terminal screws may break them.

Install power cables at least 1 metre away from televisions or radios to prevent interference. Depending on the radio waves, a distance of 1 metre may not be sufficient.

**WARNING**

- After finishing the electrical work, confirm that each electrical component and terminal inside the electrical components box is connected securely.
- Make sure all covers are closed before starting up the unit.

**NOTICE**

Only applicable if the power supply is three-phase, and the compressor has an ON/OFF starting method.

If there exists the possibility of reversed phase after a momentary black out and the power goes on and off while the product is operating, attach a reversed phase protection circuit locally. Running the product in reversed phase can break the compressor and other parts.

2 About the documentation

2.1 About this document

Target audience

Authorised installers + end users

**INFORMATION**

This appliance is intended to be used by expert or trained users in shops, in light industry and on farms, or for commercial use by lay persons.

Documentation set

This document is part of a documentation set. The complete set consists of:

- General safety precautions:**

- Safety instructions that you must read before installing
- Format: Paper (in the accessory bag of the compressor unit)

- Compressor unit installation and operation manual:**

- Installation and operation instructions
- Format: Paper (in the accessory bag of the compressor unit)

- Heat exchanger unit installation manual:**

- Installation instructions
- Format: Paper (in the accessory bag of the heat exchanger unit)

- Installer and user reference guide:**

- Preparation of the installation, technical specifications, reference data,...
- Detailed step-by-step instructions and background information for basic and advanced usage
- Format: Digital files on <http://www.daikineurope.com/support-and-manuals/product-information/>

Latest revisions of the supplied documentation may be available on the regional Daikin website or via your dealer.

The original documentation is written in English. All other languages are translations.

For the installer

3 About the box

3.1 Overview: About the box

This chapter describes what you have to do after the boxes with the compressor unit and the heat exchanger unit are delivered on-site.

It contains information about:

- Unpacking and handling the units
- Removing the accessories from the units
- Removing the transportation stay (only for RKXYQ5)
- Removing the transportation EPS (only for RKXYQ8)
- Removing the transportation sheet from the heat exchanger unit

Keep the following in mind:

- At delivery, the unit must be checked for damage. Any damage must be reported immediately to the carrier's claims agent.

- Bring the packed unit as close as possible to its final installation position to prevent damage during transport.
- When handling the unit, take into account the following:



Fragile, handle the unit with care.



Keep the unit upright in order to avoid compressor damage.

- Choose on beforehand the path along which the unit is to be brought in.

3 About the box

3.2 Compressor unit

3.2.1 To unpack the compressor unit

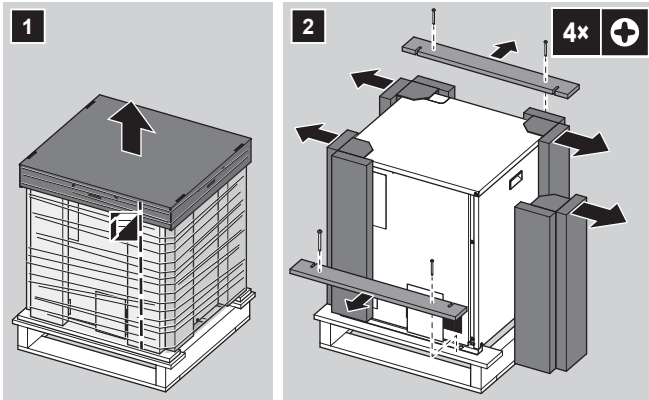

3.2.2 To handle the compressor unit

- **With packing.** Use a forklift.

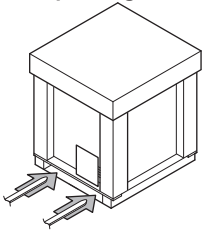

- **Without packing.** Carry the unit slowly as shown:

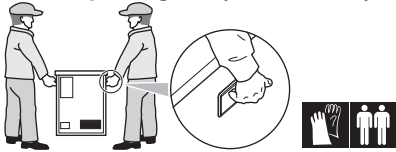

3.2.3 To remove the accessories from the compressor unit

- 1 Remove the accessories (part 1).

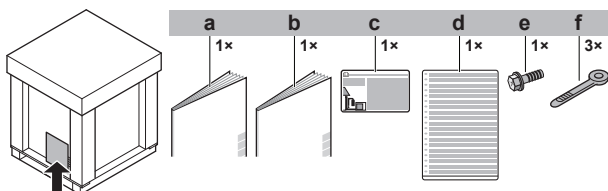

- a General safety precautions
- b Compressor unit installation and operation manual
- c Fluorinated greenhouse gases label
- d Multilingual fluorinated greenhouse gases label
- e Screw (only needed in case 5 HP for shield of transmission wiring) (see "6.9.4 To connect the electrical wiring on the compressor unit" on page 30)
- f Cable tie

- 2 Remove the service cover. See "6.2.2 To open the compressor unit" on page 17.
- 3 Remove the accessories (part 2).

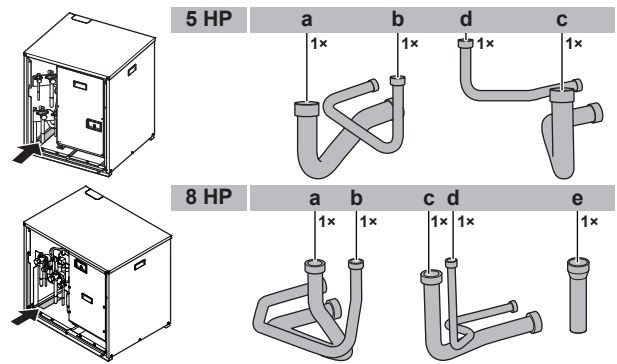

a+b Piping accessories for circuit 1 (to the heat exchanger unit)

		5 HP	8 HP
a	Gas	Ø19.1 mm	Ø22.2 mm
b	Liquid	Ø12.7 mm	Ø12.7 mm

c+d Piping accessories for circuit 2 (to the indoor units)

		5 HP	8 HP
c	Gas	Ø15.9 mm	Ø19.1 mm
d	Liquid	Ø9.5 mm	Ø9.5 mm

- e Piping adapter (Ø19.1→22.2 mm) that you need when connecting piping to the heat exchanger unit (only for 8 HP)

3.2.4 To remove the transportation stay

Only for RKXYQ5.



NOTICE

If the unit is operated with the transportation stay attached, abnormal vibration or noise may be generated.

The transportation stay installed over the compressor leg for protecting the unit during transport must be removed. Proceed as shown in the figure and procedure below.

- 1 Slightly loosen the fixing nut (a).
- 2 Remove the transportation stay (b) as shown in the figure below.
- 3 Tighten the fixing nut (a) again.

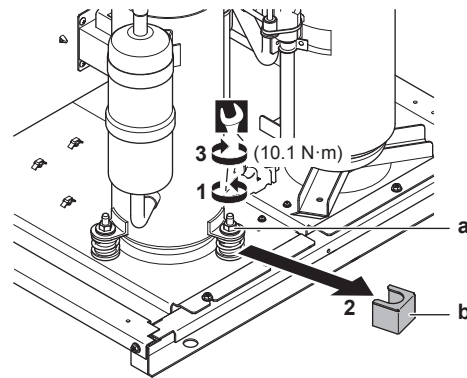

3.2.5 To remove the transportation EPS

Only for RKXYQ8.

Remove the EPS. The EPS protects the unit during transport.

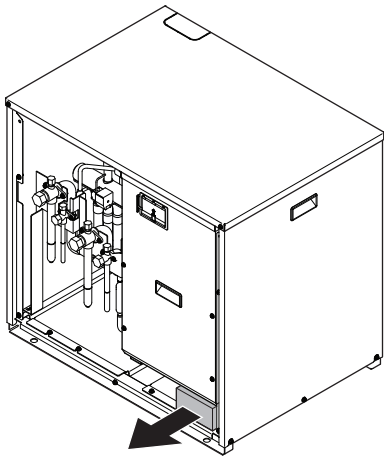

3.3 Heat exchanger unit

3.3.1 To unpack the heat exchanger unit

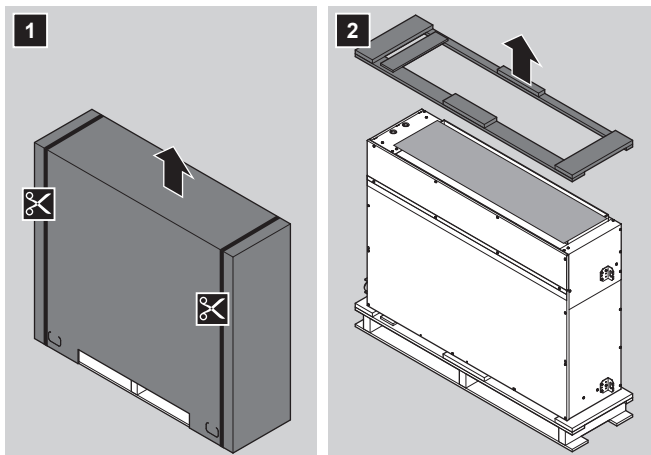

3.3.2 To handle the heat exchanger unit



NOTICE

When removing the heat exchanger unit from the pallet, do NOT place the suction or discharge side of the unit on the floor. **Possible consequence:** Deformation of the suction or discharge opening.



CAUTION

To avoid injury, do NOT touch the air inlet or aluminum fins of the unit.

- **With packing.** Use a forklift or slings.

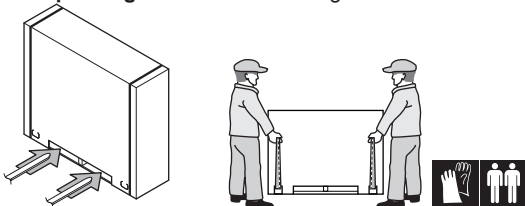

- **Without packing.** Carry the unit slowly as shown:

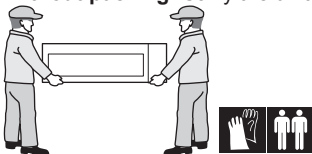

3.3.3 To remove the accessories from the heat exchanger unit

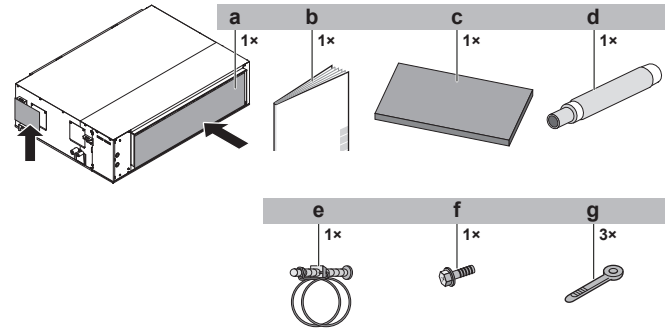

- a Optional filter for debris
- b Heat exchanger unit installation manual
- c Sealing pad
- d Drain hose
- e Metal clamp
- f Screw (for shield of transmission wiring) (see "6.9.5 To connect the electrical wiring on the heat exchanger unit" on page 31)
- g Cable tie

3.3.4 To remove the transportation sheet

Remove the sheet. The sheet protects the unit during transport.

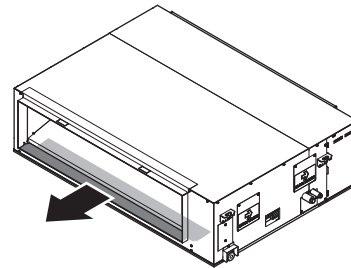

4 About the units and options

4.1 Overview: About the units and options

This chapter contains information about:

- Identification of the compressor unit and heat exchanger unit.
- Where the compressor unit and heat exchanger unit fit in the system layout.
- With which indoor units and options you can combine the compressor unit and heat exchanger unit.

4.2 Identification



NOTICE

When installing or servicing several units at the same time, make sure NOT to switch the service panels between different models.

4 About the units and options

4.2.1 Identification label: Compressor unit

Location

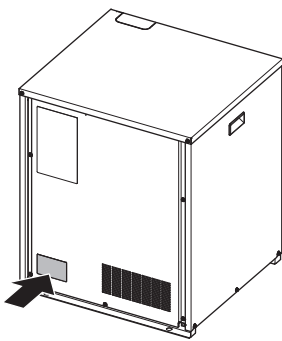

Model identification

Example: R K X Y Q 5 T7 Y1 B [*]

Code	Explanation
R	Outdoor air cooled
K	Compressor unit
X	Heat pump (no continuous heating)
Y	Single module
Q	Refrigerant R410A
5+8	Capacity class
T7	VRV IV series
Y1	Power supply
B	European market
[*]	Minor model change indication

4.2.2 Identification label: Heat exchanger unit

Location

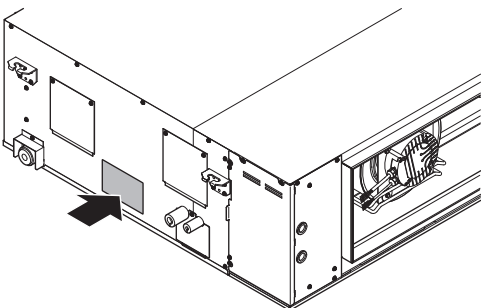

Model identification

Example: R D X Y Q 5 T7 V1 B [*]

Code	Explanation
R	Outdoor air cooled
D	Heat exchanger unit
X	Heat pump (no continuous heating)
Y	Single module
Q	Refrigerant R410A
5+8	Capacity class
T7	VRV IV series
V1	Power supply
B	European market
[*]	Minor model change indication

4.3 About the compressor unit and heat exchanger unit

This installation manual concerns the full inverter driven VRV IV heat pump for indoor installation.

The compressor unit and heat exchanger unit are intended for indoor installation and aimed for air to air heat pump applications.

Specification		5 HP	8 HP
Maximum capacity	Heating	16.0 kW	25.0 kW
	Cooling	14.0 kW	22.4 kW
Outside ambient design temperature	Heating	-20~15.5°C WB	
	Cooling	-5~46°C DB	
Ambient design temperature of compressor unit and heat exchanger unit		5~35°C DB	
Maximum relative humidity around the compressor unit and heat exchanger unit	Heating	50% ^(a)	
	Cooling	80% ^(a)	

(a) To avoid condensation and water dripping out of the unit. If the temperature or the humidity is beyond these conditions, safety devices may be put in action and the air conditioner may not operate.

4.4 System layout



NOTICE

Design of the system must not be done at temperatures below -15°C.



INFORMATION

Not all combinations of indoor units are allowed, for guidance, see "4.5.2 Possible combinations of indoor units" on page 11.

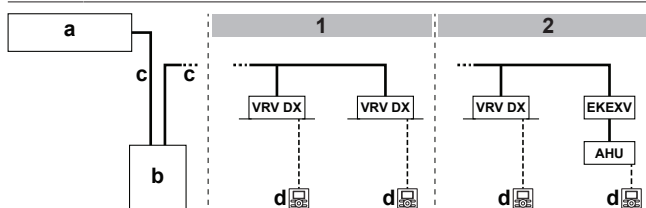

1 In case of VRV DX indoor units

2 In case of VRV DX indoor units combined with an air handling unit

a Heat exchanger unit

b Compressor unit

c Refrigerant piping

d User interface (dedicated depending on indoor unit type)

VRV DX VRV direct expansion (DX) indoor unit

EKEXV Expansion valve kit

AHU Air handling unit

4.5 Combining units and options

4.5.1 About combining units and options



NOTICE

To be sure your system setup (compressor unit+heat exchanger unit+indoor unit(s)) will work, you have to consult the latest technical engineering data for the VRV IV heat pump for indoor installation.

The VRV IV heat pump for indoor installation can be combined with several types of indoor units and is intended for R410A use only.

For an overview which units are available you can consult the product catalogue for the VRV IV heat pump for indoor installation.

4 About the units and options

An overview is given indicating the allowed combinations of indoor units, compressor units and heat exchanger units. Not all combinations are allowed. They are subject to rules mentioned in the technical engineering data.

4.5.2 Possible combinations of indoor units

In general following type of indoor units can be connected to a VRV IV heat pump for indoor installation. The list is non-exhaustive and is depending on the combination of compressor unit, heat exchanger unit and indoor unit models.

- VRV direct expansion (DX) indoor units (air to air applications).
- AHU (air-to-air applications): EKEXV-kit+EKEQM-box required, depending on the application.
- Comfort air curtain (air-to-air applications): CYV (Biddle) series.

When selecting indoor unit, following table with connection ratio limitation has to be respected. More detailed information can be found in technical engineering data.

Indoor units used	Capacity CR
VRV DX only	Total: 50~130%
VRV DX + AHU	Total: 50~110% Allowable per indoor unit type: <ul style="list-style-type: none"> • VRV DX: 50~110% • AHU: 0~60%
AHU only	Total: 90~110%
FXMQ-MF only	Total: 50~100%

Other combinations than those mentioned above are not allowed.

4.5.3 Possible options for the compressor unit and heat exchanger unit



INFORMATION

Refer to the technical engineering data for the latest option names.

Refrigerant branching kit

Description	Model name
Refnet header	KHRQ22M29H
Refnet joint	KHRQ22M20T KHRQ22M29T9

For the selection of the optimal branching kit, please refer to "5.3.4 To select refrigerant branch kits" on page 15.

External control adaptor (DTA104A61/62)

To instruct specific operation with an external input coming from a central control the external control adaptor can be used. Instructions (group or individual) can be instructed for low noise operation and power consumption limitation operation.

The external control adaptor has to be installed in the indoor unit.

PC configurator cable (EKPCAB)

You can make several commissioning field settings through a personal computer interface. For this option EKPCAB is required which is a dedicated cable to communicate with the compressor unit. The user interface software is available on <http://www.daikineurope.com/support-and-manuals/software-downloads/>.

Cool/heat selector

In order to control the cooling or heating operation from a central location, the following option can be connected:

Description	5 HP	8 HP
Cool/heat selector switch	KRC19-26A	

Description	5 HP	8 HP
Cool/heat selector cable	EKCHSC	—
Cool/heat selector PCB	—	BRP2A81 ^(a)
With optional fixing box for the switch	KJB111A	

(a) To install BRP2A81, proceed as follows:

- 1 Check the components of BRP2A81. You do NOT need all of them.

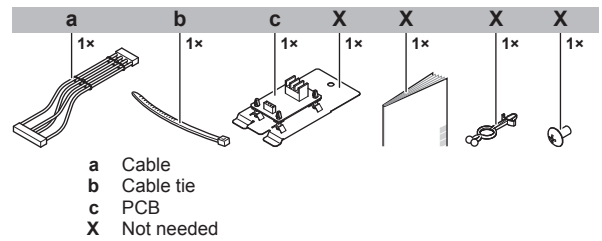

- 2 Remove the service covers of the compressor unit and the switch box. See "6.2.2 To open the compressor unit" on page 17.
- 3 Remove the mounting plate from the PCB.

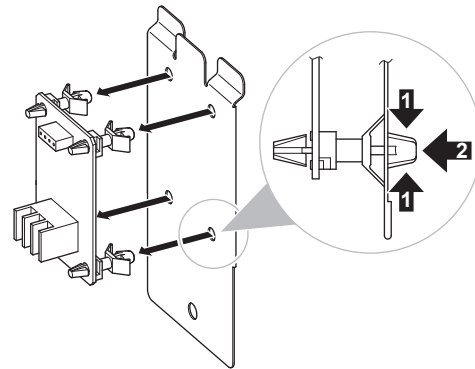

- 4 Mount the PCB.

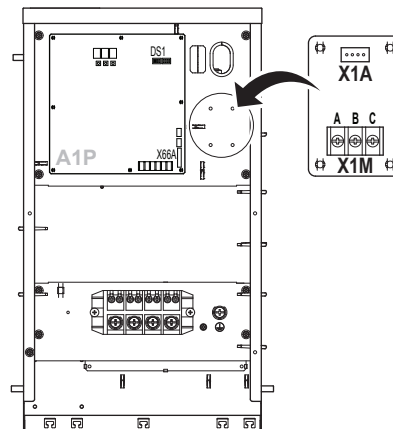

- 5 Connect the cable.

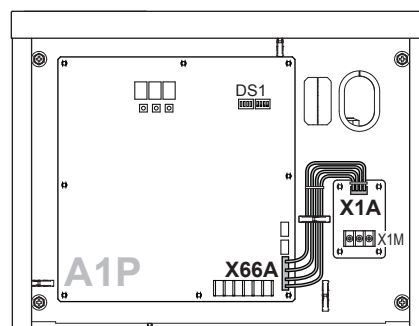

5 Preparation

- 6 Connect the cool/heat selector switch. Tightening torque X1M (A/B/C): 0.53~0.63 N·m

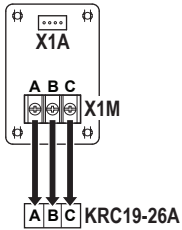

- 7 Fix the cables with cable ties.
8 Turn ON the DIP switch (DS1-1).

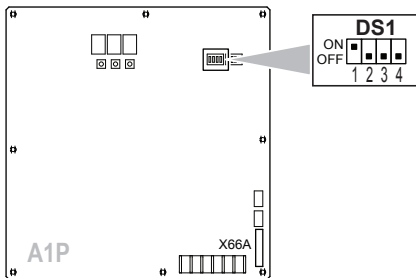

- 9 Reattach the service covers. See "6.10.2 To close the compressor unit" on page 32.
10 Perform a test run. See the "Commissioning" chapter.

Drain pan heater (EKDPH1RDX)

- **When.** Installation is optional. It is recommended in areas where the outside temperature is below -7°C for more than 24 hours continuously.
- **Where.** Install the drain pan heater in the heat exchanger unit.
- **How.** See the installation instructions delivered with the drain pan heater.

Filter for debris (delivered as accessory)

- **When.** Installation is optional. It is recommended in places where a lot of debris or dirt (example: leaves) can go into the suction ducting.
- **Where.** Install the filter in one of the following places:
 - Suction opening of the heat exchanger unit
 - Suction ducting (easier for maintenance)
- **How.** See the installation instructions attached to the filter.
- **Pressure drop over the filter:**
 - 5 HP: 30 Pa at $60\text{ m}^3/\text{min}$
 - 8 HP: 75 Pa at $100\text{ m}^3/\text{min}$

5 Preparation

5.1 Overview: Preparation

This chapter describes what you have to do and know before going on-site.

It contains information about:

- Preparing the installation site
- Preparing the refrigerant piping
- Preparing the electrical wiring

5.2 Preparing installation site

Do NOT install the unit in places often used as work place. In case of construction works (e.g. grinding works) where a lot of dust is created, the unit must be covered.

Choose the installation location with sufficient place for carrying the unit in and out of the site.

5.2.1 Installation site requirements of the compressor unit

i INFORMATION

Also read the following requirements:

- General installation site requirements. See the "General safety precautions" chapter.
- Refrigerant piping requirements (length, height difference). See further in this "Preparation" chapter.

! CAUTION

Appliance not accessible to the general public, install it in a secured area, protected from easy access.

These units (compressor unit, heat exchanger unit and indoor units) are suitable for installation in a commercial and light industrial environment.

! NOTICE

This is a class A product. In a domestic environment this product may cause radio interference in which case the user may be required to take adequate measures.

! NOTICE

The equipment described in this manual may cause electronic noise generated from radio-frequency energy. The equipment complies to specifications that are designed to provide reasonable protection against such interference. However, there is no guarantee that interference will not occur in a particular installation.

It is therefore recommended to install the equipment and electric wires keeping proper distances away from stereo equipment, personal computers, etc.

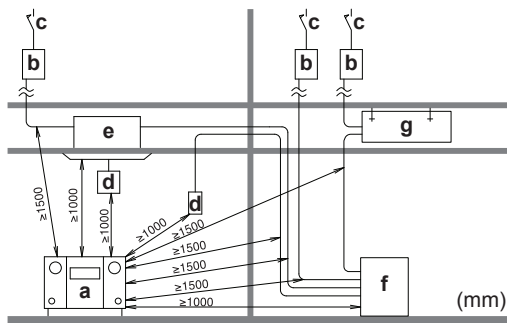

- a Personal computer or radio
- b Fuse
- c Earth leakage protector
- d User interface
- e Indoor unit
- f Compressor unit
- g Heat exchanger unit

In places with weak reception, keep distances of 3 m or more to avoid electromagnetic disturbance of other equipment and use conduit tubes for power and transmission lines.

- Service space. Mind the following requirements:

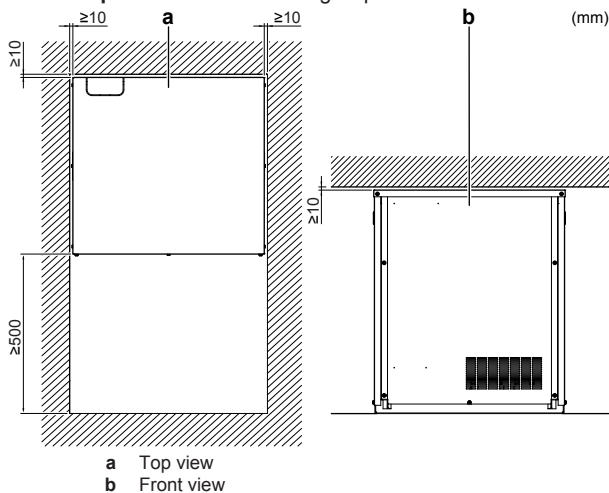

- Take care that in the event of a water leak, water cannot cause any damage to the installation space and surroundings.
- Choose a location where the hot/cold air discharged from the unit or the operation noise, will NOT disturb anyone.

Do NOT install the unit in the following places:

- Sound sensitive areas (e.g. near a bedroom and the like), so that the operation noise will cause no trouble.
Note: If the sound is measured under actual installation conditions, the measured value might be higher than the sound pressure level mentioned in Sound spectrum in the data book due to environmental noise and sound reflections.
- In places where a mineral oil mist, spray or vapour may be present in the atmosphere. Plastic parts may deteriorate and fall off or cause water leakage.

It is NOT recommended to install the unit in the following places because it may shorten the life of the unit:

- Where the voltage fluctuates a lot
- In vehicles or vessels
- Where acidic or alkaline vapour is present

5.2.2 Installation site requirements of the heat exchanger unit

The heat exchanger unit has the same installation site requirements as the compressor unit, and a few additional ones:

- Heat exchanger fins are sharp and injury is possible. Choose an installation location where there is no risk for injury (especially in areas where children play).

- Service space. Mind the following requirements:

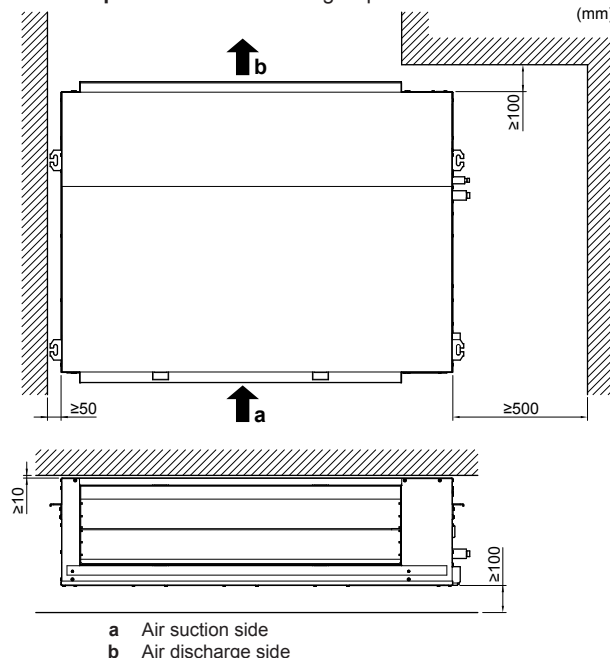

- Protective guards.** Make sure to install protective guards on the suction and discharge side to prevent somebody from touching the fan blades or heat exchanger.
- Air flow.** Make sure nothing blocks the air flow.
- Drainage.** Make sure condensation water can be evacuated properly.
- Seaside installation.** Do NOT install directly exposed to seawinds. This is to prevent corrosion caused by high levels of salt in the air, which might shorten the life of the unit.

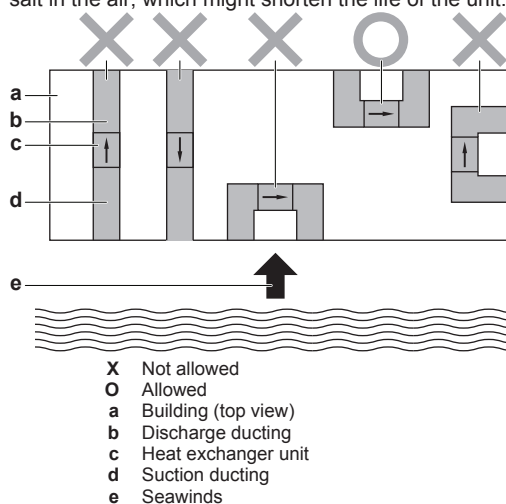

5.2.3 Securing safety against refrigerant leaks

About safety against refrigerant leaks

The installer and system specialist shall secure safety against leakage according to local regulations or standards. The following standards may be applicable if local regulations are not available.

This system uses R410A as refrigerant. R410A itself is an entirely safe non-toxic, non-combustible refrigerant. Nevertheless care must be taken to ensure that the system is installed in a room which is sufficiently large. This assures that the maximum concentration level of refrigerant gas is not exceeded, in the unlikely event of major leak in the system and this in accordance to the local applicable regulations and standards.

5 Preparation

About the maximum concentration level

The maximum charge of refrigerant and the calculation of the maximum concentration of refrigerant is directly related to the humanly occupied space in to which it could leak.

The unit of measurement of the concentration is kg/m^3 (the weight in kg of the refrigerant gas in 1 m^3 volume of the occupied space).

Compliance to the local applicable regulations and standards for the maximum allowable concentration level is required.

According to the appropriate European Standard, the maximum allowed concentration level of refrigerant to a humanly space for R410A is limited to 0.44 kg/m^3 .

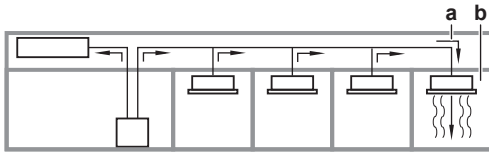

- a** Direction of the refrigerant flow
b Room where refrigerant leak has occurred (outflow of all the refrigerant from the system)

Pay special attention to places, such as basements etc., where refrigerant can stay, since refrigerant is heavier than air.

To check the maximum concentration level

Check the maximum concentration level in accordance with steps 1 to 4 below and take whatever action is necessary to comply.

- 1 Calculate the amount of refrigerant (kg) charged to each system separately.

Formula	A+B=C
A	Amount of refrigerant in a single unit system (amount of refrigerant with which the system is charged before leaving the factory)
B	Additional charging amount (amount of refrigerant added locally)
C	Total amount of refrigerant (kg) in the system

NOTICE

Where a single refrigerant facility is divided into 2 entirely independent refrigerant systems, use the amount of refrigerant with which each separate system is charged.

- 2 Calculate the volume of the room (m^3) where the unit is installed. In a case such as the following, calculate the volume of (D), (E) as a single room or as the smallest room.

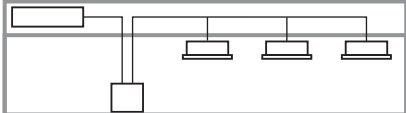
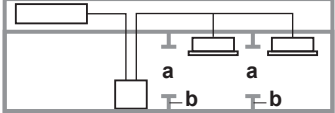
D	Where there are no smaller room divisions: 
E	Where there is a room division, but there is an opening between the rooms sufficiently large to permit a free flow of air back and forth.  a Opening between the rooms b Partition (Where there is an opening without a door or where there are openings above and below the door which are each equivalent in size to 0.15% or more of the floor area.)

- 3 Calculate the refrigerant density using the results of the calculations in steps 1 and 2 above. If the result of the above calculation exceeds the maximum concentration level, a ventilation opening to the adjacent room shall be made.

Formula	$F/G \leq H$
F	Total volume of refrigerant in the refrigerant system
G	Size (m^3) of smallest room in which there is a unit installed
H	Maximum concentration level (kg/m^3)

- 4 Calculate the refrigerant density taking the volume of the room where the unit is installed and the adjacent room. Install ventilation openings in the door of adjacent rooms until the refrigerant density is smaller than the maximum concentration level.

5.3 Preparing refrigerant piping

5.3.1 Refrigerant piping requirements

INFORMATION

Also read the precautions and requirements in the "General safety precautions" chapter.

NOTICE

The refrigerant R410A requires strict cautions for keeping the system clean, dry and tight.

- Clean and dry: foreign materials (including mineral oils or moisture) should be prevented from getting mixed into the system.
- Tight: R410A does not contain any chlorine, does not destroy the ozone layer, and does not reduce earth's protection against harmful ultraviolet radiation. R410A can contribute slightly to the greenhouse effect if it is released. Therefore we should take special attention to check the tightness of the installation.

NOTICE

The piping and other pressure-containing parts shall be suitable for refrigerant. Use phosphoric acid deoxidised seamless copper for refrigerant.

- Foreign materials inside pipes (including oils for fabrication) must be $\leq 30 \text{ mg/10 m}$.

5.3.2 Refrigerant piping material

- **Piping material:** Phosphoric acid deoxidised seamless copper.
- **Piping temper grade and thickness:**

Outer diameter (\varnothing)	Temper grade	Thickness (t) ^(a)	
6.4 mm (1/4")	Annealed (O)	$\geq 0.80 \text{ mm}$	
9.5 mm (3/8")			
12.7 mm (1/2")			
15.9 mm (5/8")	Annealed (O)	$\geq 0.99 \text{ mm}$	
19.1 mm (3/4")	Half hard (1/2H)	$\geq 0.80 \text{ mm}$	
22.2 mm (7/8")			

- (a) Depending on the applicable legislation and the unit's maximum working pressure (see "PS High" on the unit name plate), larger piping thickness might be required.

5.3.3 To select the piping size

Determine the proper size referring to following tables and reference figure (only for indication).

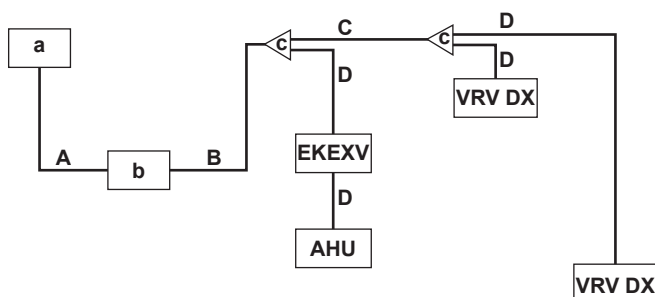

- a Heat exchanger unit
- b Compressor unit
- c Refrigerant branch kit
- VRV DX VRV DX indoor unit
- EKE XV Expansion valve kit
- AHU Air handling unit
- A Piping between heat exchanger unit and compressor unit
- B Piping between compressor unit and (first) refrigerant branch kit (= main pipe)
- C Piping between refrigerant branch kits
- D Piping between refrigerant branch kit and indoor unit

In case the required pipe sizes (inch sizes) are not available, it is also allowed to use other diameters (mm sizes), taken the following into account:

- Select the pipe size nearest to the required size.
- Use the suitable adapters for the change-over from inch to mm pipes (field supply).
- The additional refrigerant calculation has to be adjusted as mentioned in "6.8.3 To determine the additional refrigerant amount" on page 26.

A: Piping between heat exchanger unit and compressor unit

Use the following diameters:

Compressor unit capacity type	Piping outer diameter size (mm)	
	Gas pipe	Liquid pipe
5 HP	19.1	12.7
8 HP	22.2	

B: Piping between compressor unit and first refrigerant branch kit

Use the following diameters:

Compressor unit capacity type	Piping outer diameter size (mm)			
	Gas pipe		Liquid pipe	
	Standard	Size-up	Standard	Size-up
5 HP	15.9	19.1	9.5	—
8 HP	19.1	22.2	9.5	12.7

Standard ↔ Size-up:

If		Then
The equivalent pipe length between the heat exchanger unit and the furthest indoor unit is 90 m or more	5 HP	It is recommended to increase the size (size-up) of the main gas pipe (between compressor unit and first refrigerant branch kit). If the recommended gas pipe (size-up) is not available, you must use the standard size (which might result in a small capacity decrease).
	8 HP	<ul style="list-style-type: none"> • You must increase the size (size-up) of the main liquid pipe (between compressor unit and first refrigerant branch kit). • It is recommended to increase the size (size-up) of the main gas pipe (between compressor unit and first refrigerant branch kit). If the recommended gas pipe (size-up) is not available, you must use the standard size (which might result in a small capacity decrease).

C: Piping between refrigerant branch kits

Use the following diameters:

Indoor unit capacity index	Piping outer diameter size (mm)	
	Gas pipe	Liquid pipe
<150	15.9	9.5
150 ≤ x < 200	19.1	
200 ≤ x < 260	22.2	

D: Piping between refrigerant branch kit and indoor unit

Use the same diameters as the connections (liquid, gas) on the indoor units. The diameters of the indoor units are as follows:

Indoor unit capacity index	Piping outer diameter size (mm)	
	Gas pipe	Liquid pipe
15~50	12.7	6.4
63~140	15.9	9.5
200	19.1	
250	22.2	

5.3.4 To select refrigerant branch kits

For piping example, refer to "5.3.3 To select the piping size" on page 15.

Refnet joint at first branch (counting from the compressor unit)

When using refnet joints at the first branch counted from the compressor unit side, choose from the following table in accordance with the capacity of the compressor unit. **Example:** Refnet joint c (B→C/D).

Compressor unit capacity type	Refrigerant branch kit
5 HP	KHRQ22M20T
8 HP	KHRQ22M29T9

Refnet joints at other branches

For refnet joints other than the first branch, select the proper branch kit model based on the total capacity index of all indoor units connected after the refrigerant branch. **Example:** Refnet joint c (C→D/D).

Indoor unit capacity index	Refrigerant branch kit
<200	KHRQ22M20T

5 Preparation

Indoor unit capacity index	Refrigerant branch kit
200≤x<260	KHRQ22M29T9

Refnet headers

Concerning refnet headers, choose from the following table in accordance with the total capacity of all the indoor units connected below the refnet header.

Indoor unit capacity index	Refrigerant branch kit
<260	KHRQ22M29H

i INFORMATION

Maximum 8 branches can be connected to a header.

5.3.5 Refrigerant piping length and height difference

The piping lengths and height differences must comply with the following requirements.

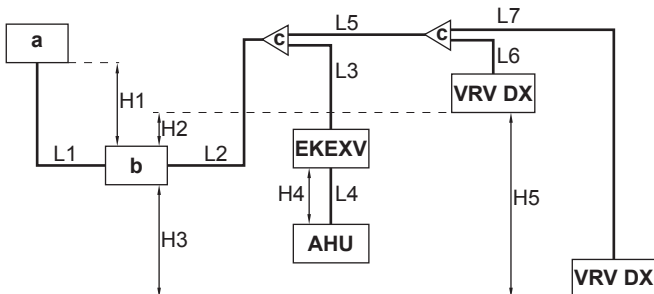

- a Heat exchanger unit
- b Compressor unit
- c Refrigerant branch kit
- VRV DX VRV DX indoor unit
- EKEXV Expansion valve kit
- AHU Air handling unit
- H1~H5 Height differences
- L1~L7 Piping lengths

Minimum and maximum piping lengths																						
1	Heat exchanger unit → Compressor unit	L1≤30 m																				
2	Actual piping length (equivalent piping length) ^(a)	L2+L3+L4≤70 m (90 m) L2+L5+L6≤70 m (90 m) L2+L5+L7≤70 m (90 m)																				
3	Total piping length (x=L1+L2+L3+L4+L5+L6+L7)	<table border="1"> <tr> <td>Minimum</td> <td>10 m≤x</td> </tr> <tr> <td>Maximum in case of 8 HP</td> <td>x≤300 m</td> </tr> <tr> <td>Maximum in case of 5 HP</td> <td> <table border="1"> <thead> <tr> <th>If</th> <th>Then</th> </tr> </thead> <tbody> <tr> <td>L1≤30 m</td> <td>x≤115 m</td> </tr> <tr> <td>L1≤25 m</td> <td>x≤120 m</td> </tr> <tr> <td>L1≤20 m</td> <td>x≤125 m</td> </tr> <tr> <td>L1≤15 m</td> <td>x≤130 m</td> </tr> <tr> <td>L1≤10 m</td> <td>x≤135 m</td> </tr> <tr> <td>L1≤5 m</td> <td>x≤140 m</td> </tr> </tbody> </table> </td> </tr> </table>	Minimum	10 m≤x	Maximum in case of 8 HP	x≤300 m	Maximum in case of 5 HP	<table border="1"> <thead> <tr> <th>If</th> <th>Then</th> </tr> </thead> <tbody> <tr> <td>L1≤30 m</td> <td>x≤115 m</td> </tr> <tr> <td>L1≤25 m</td> <td>x≤120 m</td> </tr> <tr> <td>L1≤20 m</td> <td>x≤125 m</td> </tr> <tr> <td>L1≤15 m</td> <td>x≤130 m</td> </tr> <tr> <td>L1≤10 m</td> <td>x≤135 m</td> </tr> <tr> <td>L1≤5 m</td> <td>x≤140 m</td> </tr> </tbody> </table>	If	Then	L1≤30 m	x≤115 m	L1≤25 m	x≤120 m	L1≤20 m	x≤125 m	L1≤15 m	x≤130 m	L1≤10 m	x≤135 m	L1≤5 m	x≤140 m
Minimum	10 m≤x																					
Maximum in case of 8 HP	x≤300 m																					
Maximum in case of 5 HP	<table border="1"> <thead> <tr> <th>If</th> <th>Then</th> </tr> </thead> <tbody> <tr> <td>L1≤30 m</td> <td>x≤115 m</td> </tr> <tr> <td>L1≤25 m</td> <td>x≤120 m</td> </tr> <tr> <td>L1≤20 m</td> <td>x≤125 m</td> </tr> <tr> <td>L1≤15 m</td> <td>x≤130 m</td> </tr> <tr> <td>L1≤10 m</td> <td>x≤135 m</td> </tr> <tr> <td>L1≤5 m</td> <td>x≤140 m</td> </tr> </tbody> </table>	If	Then	L1≤30 m	x≤115 m	L1≤25 m	x≤120 m	L1≤20 m	x≤125 m	L1≤15 m	x≤130 m	L1≤10 m	x≤135 m	L1≤5 m	x≤140 m							
If	Then																					
L1≤30 m	x≤115 m																					
L1≤25 m	x≤120 m																					
L1≤20 m	x≤125 m																					
L1≤15 m	x≤130 m																					
L1≤10 m	x≤135 m																					
L1≤5 m	x≤140 m																					
4	EKEXV → AHU	L4≤5 m																				
5	First branch kit → Indoor unit/AHU	L3+L4≤40 m L5+L6≤40 m L5+L7≤40 m																				
Maximum height differences ^(b)																						
1	Heat exchanger unit ↔ Compressor unit	H1≤10 m																				
2	Compressor unit ↔ Indoor unit	H2≤30 m H3≤30 m																				

3	EKEXV ↔ AHU	H4≤5 m
4	Indoor unit ↔ Indoor unit	H5≤15 m

- (a) Assume equivalent piping length of refnet joint=0.5 m and refnet header=1 m (for calculation purposes of equivalent piping length, not for refrigerant charge calculations).
- (b) Either unit can be the highest unit.

5.4 Preparing electrical wiring

5.4.1 About electrical compliance

Only for RKXYQ8

This equipment complies with:

- EN/IEC 61000-3-12 provided that the short-circuit power S_{sc} is greater than or equal to the minimum S_{sc} value at the interface point between the user's supply and the public system.
- EN/IEC 61000-3-12 = European/International Technical Standard setting the limits for harmonic currents produced by equipment connected to public low-voltage systems with input current >16 A and ≤75 A per phase.
- It is the responsibility of the installer or user of the equipment to ensure, by consultation with the distribution network operator if necessary, that the equipment is connected only to a supply with a short-circuit power S_{sc} greater than or equal to the minimum S_{sc} value.

Model	Minimum S_{sc} value
RKXYQ8	3329 kVA

5.4.2 Safety device requirements

! NOTICE

When using residual current operated circuit breakers, be sure to use a high-speed type 300 mA rated residual operating current.

Power supply: Compressor unit

The power supply must be protected with the required safety devices, i.e. a main switch, a slow blow fuse on each phase and an earth leakage protector in accordance with the applicable legislation.

Selection and sizing of the wiring should be done in accordance with the applicable legislation based on the information mentioned in the table below.

Model	Minimum circuit ampacity	Recommended fuses
RKXYQ5	13.5 A	16 A
RKXYQ8	17.4 A	20 A

- Phase and frequency: 3N~ 50 Hz
- Voltage: 380-415 V

Power supply: Heat exchanger unit

The power supply must be protected with the required safety devices, i.e. a main switch, a slow blow fuse on each phase and an earth leakage protector in accordance with the applicable legislation.

Selection and sizing of the wiring should be done in accordance with the applicable legislation based on the information mentioned in the table below.

Model	Minimum circuit ampacity	Recommended fuses
RDXYQ5	4.6 A	10 A
RDXYQ8	7.0 A	10 A

- Phase and frequency: 1~ 50 Hz
- Voltage: 220-240 V

Transmission wiring

Transmission line section:

Transmission wiring	Sheathed + shielded cable (2 wires) Vinyl cords 0.75~1.25 mm ² (using shielded cable for the transmission wiring is mandatory for 5 HP, and optional for 8 HP)
Maximum wiring length (= distance between compressor unit and furthest indoor unit)	300 m
Total wiring length (= distance between compressor unit and all indoor units, and between compressor unit and heat exchanger unit)	600 m

If the total transmission wiring exceeds these limits, it may result in communication error.

6 Installation

6.1 Overview: Installation

This chapter describes what you have to do and know on-site to install the system.

Typical workflow

Installation typically consists of the following stages:

- Mounting the compressor unit.
- Mounting the heat exchanger unit (+ ducting + filter for debris + drain pump + optional equipment).
- Mounting the indoor units.
- Connecting the refrigerant piping.
- Checking the refrigerant piping.
- Charging refrigerant.
- Connecting the electrical wiring.
- Finishing the compressor unit installation.
- Finishing the heat exchanger unit installation.
- Finishing the indoor installation.

**INFORMATION**

For installation of the indoor unit (mounting the indoor unit, connecting the refrigerant piping to the indoor unit, connecting the electrical wiring to the indoor unit ...), see the installation manual of the indoor unit.

6.2 Opening the units

6.2.1 About opening the units

At certain times, you have to open the unit. **Example:**

- When connecting the refrigerant piping
- When connecting the electrical wiring
- When maintaining or servicing the unit

**DANGER: RISK OF ELECTROCUTION**

Do NOT leave the unit unattended when the service cover is removed.

6.2.2 To open the compressor unit

**DANGER: RISK OF BURNING****DANGER: RISK OF ELECTROCUTION**

- 1 Remove the service cover of the compressor unit.

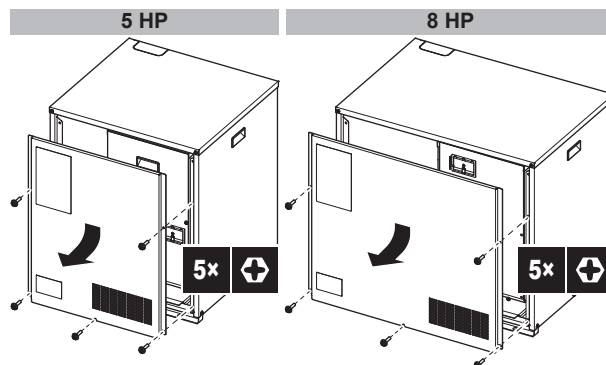

- 2 If you want to make **field settings**, remove the inspection cover.

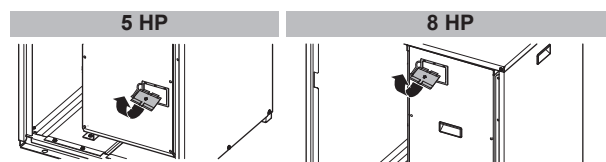

- 3 If you want to connect **electrical wiring**, remove the switch box cover.

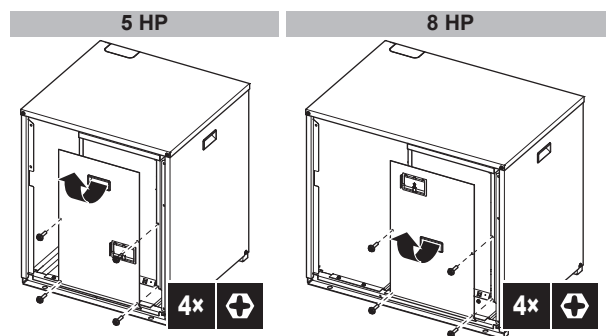

6.2.3 To open the switch box cover of the heat exchanger unit

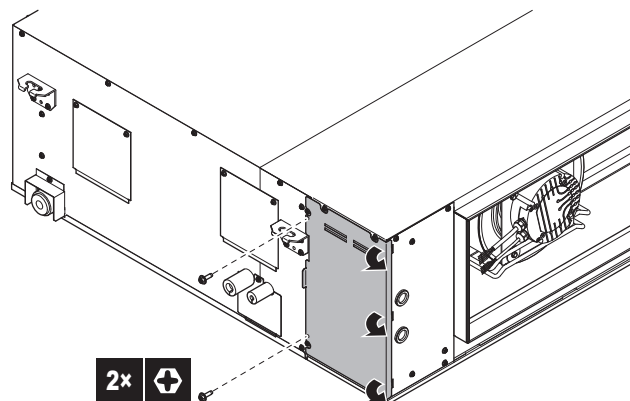
**DANGER: RISK OF ELECTROCUTION**

6 Installation

6.3 Mounting the compressor unit

6.3.1 Precautions when mounting the compressor unit



INFORMATION

Also read the precautions and requirements in the following chapters:

- General safety precautions
- Preparation

6.3.2 Guidelines when installing the compressor unit

Check the strength and level of the installation ground so that the unit will not cause any operating vibration or noise. If the vibration might be transmitted to the building, use a vibration-proof rubber (field supply).

You can install the compressor unit directly on the floor or on a structure.

- On the floor.** You do NOT have to fix the unit with anchor bolts.
- On a structure.** Fix the unit securely with anchor bolts, nuts and washers (field supply) to the structure. The foundation (steel beam frame or concrete) must be larger than the grey marked area.

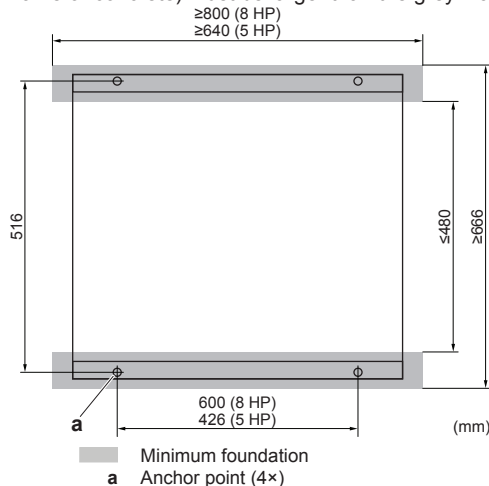

INFORMATION

The recommended height of the upper protruding part of the bolts is 20 mm.

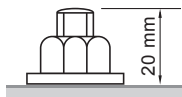

6.4 Mounting the heat exchanger unit

6.4.1 Precautions when mounting the heat exchanger unit



INFORMATION

Also read the precautions and requirements in the following chapters:

- General safety precautions
- Preparation

6.4.2 Guidelines when installing the heat exchanger unit



INFORMATION

Optional equipment. When installing optional equipment, also read the installation manual of the optional equipment. Depending on the field conditions, it might be easier to install the optional equipment first.

- Suspension bolts.** Use suspension bolts for installation. Check whether the ceiling is strong enough to support the weight of the unit. If there is a risk, reinforce the ceiling before installing the unit. Attach the hanger bracket to the suspension bolt. Fix it securely by using a nut and washer from the upper and lower sides of the hanger bracket.

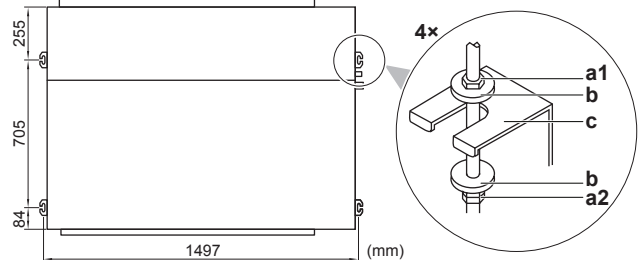

- a1 Nut
- a2 Double nut
- b Washer
- c Hanger bracket

- Drain water flow.** Make sure drain water flows to the drain pipe connection.

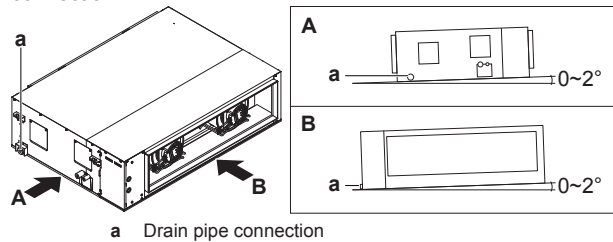

6.4.3 Guidelines when installing the ducting

The ducting is to be field supplied.

- Slope.** Make sure the ducting slopes down to prevent water from flowing into the heat exchanger unit.

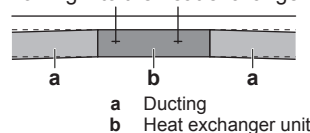

- Grills.** Install grills in the suction ducting entrance and the discharge ducting exit to prevent animals and debris from going into the ducting.
- Service holes.** Put service holes in the ducting to make maintenance easier.
- Thermal insulation.** Insulate the ducting against thermal losses to prevent sweat (during heating operation), and to prevent overheating of the building (during cooling operation).
- Sound insulation.** Insulate the ducting against noise, especially in sound-sensitive areas. **Example:** Sound-absorbing ducting; sound-absorbing baffle in the ducting.

- Air leaks.** Wind aluminium tape around the connection between the heat exchanger unit and the ducting. Make sure there are no air leaks between the ducting and the heat exchanger unit, and at any other connection. This to prevent sweat, overheating and sound problems.

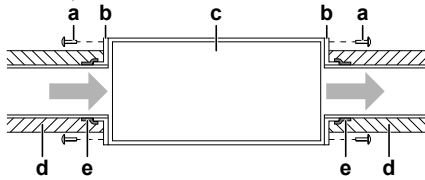

- a Screw (field supply)
- b Flange (field supply)
- c Heat exchanger unit
- d Insulation (field supply)
- e Aluminium tape (field supply)

Airflow:

- Protect the ducting against reverse airflow from wind.
- Prevent discharged air from flowing back to the suction side.
Possible consequence: Decreased performance of the unit.

- Outside air.** Connect the suction ducting and discharge ducting with the outside air. If the suction ducting or discharge ducting is connected with the inside air, it might be impossible to reach the desired room temperature.

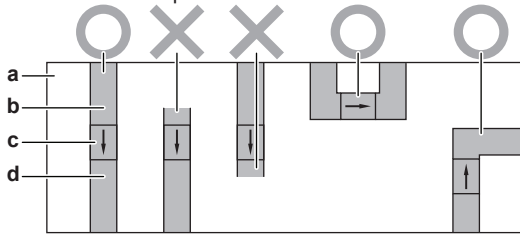

- O Allowed
- X Not allowed
- a Building (top view)
- b Suction ducting
- c Heat exchanger unit
- d Discharge ducting

6.4.4 Guidelines when installing the drain piping

Make sure condensation water can be evacuated properly. This involves:

- General guidelines
- Connecting the drain piping to the heat exchanger unit
- Installing a drain pump and drain reservoir
- Checking for water leaks

General guidelines

- Pipe length.** Keep drain piping as short as possible.
- Pipe size.** Keep the pipe size equal to or greater than that of the connecting pipe (vinyl pipe of 25 mm nominal diameter and 32 mm outer diameter).
- Slope.** Make sure the drain piping slopes down (at least 1/100) to prevent air from being trapped in the piping. Use hanging bars as shown.

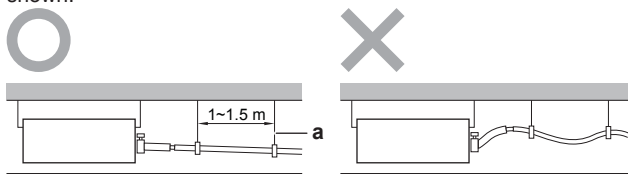

- a Hanging bar
- O Allowed
- X Not allowed

- Condensation.** Take measures against condensation. Insulate the complete drain piping in the building.
- Bad odours.** To prevent bad odours and air going into the unit through the drain piping, install a trap.

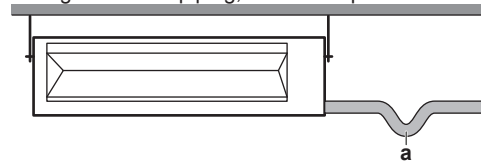

a Trap

- Combining drain pipes.** You can combine drain pipes. Make sure to use drain pipes and T-joints with a correct gauge for the operating capacity of the units.

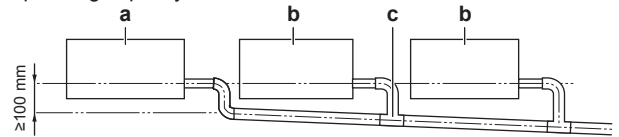

- a Heat exchanger unit
- b Indoor unit
- c T-joint

To connect the drain piping to the heat exchanger unit



NOTICE

Incorrect connection of the drain hose might cause leaks, and damage the installation space and surroundings.

- Push the drain hose as far as possible over the drain pipe connection.
- Tighten the metal clamp until the screw head is less than 4 mm from the metal clamp part.
- Wind the sealing pad (= insulation) around the metal clamp and drain hose, and fix it with cable ties.
- Connect the drain piping to the drain hose.

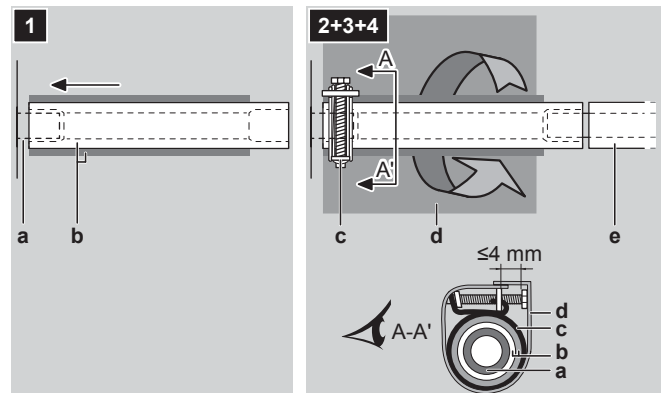

- a Drain pipe connection (attached to the unit)
- b Drain hose (accessory)
- c Metal clamp (accessory)
- d Sealing pad (accessory)
- e Drain piping (field supply)

Guidelines when installing a drain pump and drain reservoir

If you install a drain pump, you must also install a drain reservoir. The drain pump and drain reservoir are to be field supplied.

6 Installation

• Drain pump:

- **Minimum flow rate:** 45 l/h
- **Feedback contact.** You can connect a contact that gives the status of the drain pump to the heat exchanger unit. The heat pump uses this contact as an input.

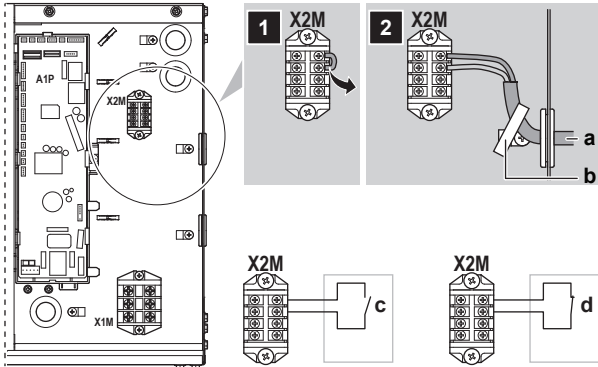

- a Feedback contact from the drain pump
- b Cable tie
- c Drain pump malfunction: If the contact opens, the heat pump stops operating and gives an error. For more information, see "11.3.1 Error codes: Overview" on page 46.
- d Drain pump normal operation: If the contact closes, the heat pump resumes normal operation.

• Drain reservoir:

- **Minimum volume:** 3 l
- **Best practice:** Use a drain reservoir with a float switch that gives an ON/OFF signal to the drain pump.

To check for water leaks

Gradually put approximately 1 l of water in the drain pan, and check for water leaks.

6.5 Connecting the refrigerant piping

6.5.1 About connecting the refrigerant piping

Before connecting the refrigerant piping

Make sure the compressor unit, heat exchanger unit and indoor units are mounted.

Typical workflow

Connecting the refrigerant piping involves:

- Connecting the refrigerant piping to the compressor unit
- Connecting the refrigerant piping to the heat exchanger unit
- Connecting refrigerant branch kits
- Connecting the refrigerant piping to the indoor units (see the installation manual of the indoor units)
- Insulating the refrigerant piping
- Keeping in mind the guidelines for:
 - Pipe bending
 - Brazing
 - Using the stop valves
 - Removing pinched pipes

6.5.2 Precautions when connecting the refrigerant piping



INFORMATION

Also read the precautions and requirements in the following chapters:

- General safety precautions
- Preparation



DANGER: RISK OF BURNING



NOTICE

Take the following precautions on refrigerant piping into account:

- Avoid anything but the designated refrigerant to get mixed into the refrigerant cycle (e.g. air).
- Only use R410A when adding refrigerant.
- Only use installation tools (e.g. manifold gauge set) that are exclusively used for R410A installations to withstand the pressure and to prevent foreign materials (e.g. mineral oils and moisture) from mixing into the system.
- Protect the piping by pinching or taping the pipe ends to prevent dirt, liquid or dust from entering the piping.
- Use caution when passing copper tubes through walls.

6.5.3 Pipe bending guidelines

Use a pipe bender for bending. All pipe bends should be as gentle as possible (bending radius should be 30~40 mm or larger).

6.5.4 To braze the pipe end



NOTICE

Precautions when connecting field piping. Add brazing material as shown in the figure.

≤Ø25.4



- When brazing, blow through with nitrogen to prevent creation of large quantities of oxidised film on the inside of the piping. This film adversely affects valves and compressors in the refrigerating system and prevents proper operation.
- Set the nitrogen pressure to 20 kPa (just enough so it can be felt on the skin) with a pressure-reducing valve.

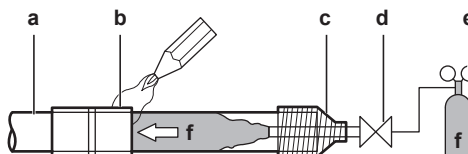

- a Refrigerant piping
- b Part to be brazed
- c Taping
- d Manual valve
- e Pressure-reducing valve
- f Nitrogen

- Do NOT use anti-oxidants when brazing pipe joints. Residue can clog pipes and break equipment.

- Do NOT use flux when brazing copper-to-copper refrigerant piping. Use phosphor copper brazing filler alloy (BCuP), which does not require flux. Flux has an extremely harmful influence on refrigerant piping systems. For instance, if chlorine based flux is used, it will cause pipe corrosion or, in particular, if the flux contains fluorine, it will deteriorate the refrigerant oil.

6.5.5 Using the stop valve and service port

To handle the stop valve

- Make sure to keep all stop valves open during operation.
- The figure below shows the name of each part required in handling the stop valve.
- The stop valve is factory closed.

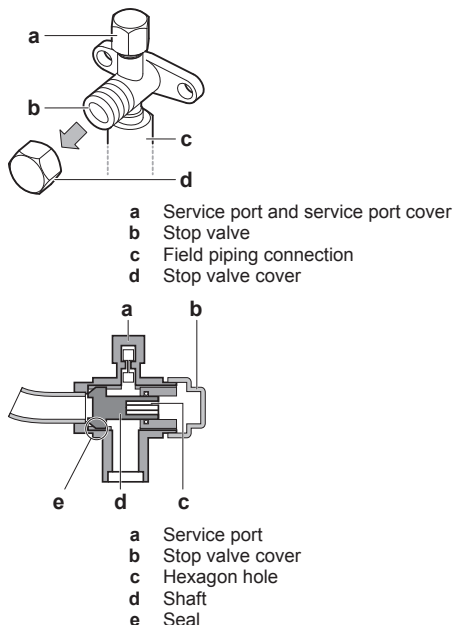

To open the stop valve

- Remove the stop valve cover.
- Insert a hexagon wrench into the stop valve and turn the stop valve counterclockwise.
- When the stop valve cannot be turned any further, stop turning.

Result: The valve is now open.

To fully open the $\varnothing 19.1$ mm stop valve, turn the hexagonal wrench until a torque between 27 and 33 N·m is achieved.

Inadequate torque may cause leakage of refrigerant and breakage of the stop valve cap.

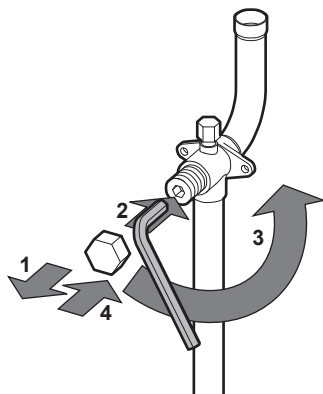

NOTICE

Pay attention that mentioned torque range is applicable for opening $\varnothing 19.1$ mm stop valves only.

To close the stop valve

- Remove the stop valve cover.
- Insert a hexagon wrench into the stop valve and turn the stop valve clockwise.
- When the stop valve cannot be turned any further, stop turning.

Result: The valve is now closed.

Closing direction:

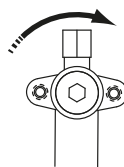

To handle the stop valve cover

- The stop valve cover is sealed where indicated by the arrow. Take care not to damage it.
- After handling the stop valve, make sure to tighten the stop valve cover securely. For the tightening torque, refer to the table below.
- Check for refrigerant leaks after tightening the stop valve cover.

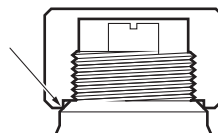

To handle the service port

- Always use a charge hose equipped with a valve depressor pin, since the service port is a Schrader type valve.
- After handling the service port, make sure to tighten the service port cover securely. For the tightening torque, refer to the table below.
- Check for refrigerant leaks after tightening the service port cover.

Tightening torques

Stop valve size (mm)	Tightening torque N·m (turn clockwise to close)			
	Shaft			
	Valve body	Hexagonal wrench	Cap (valve lid)	Service port
$\varnothing 9.5$	5.4~6.6	4 mm	13.5~16.5	11.5~13.9
$\varnothing 12.7$	8.1~9.9		18.0~22.0	
$\varnothing 19.1$	27.0~33.0	8 mm	22.5~27.5	

6.5.6 To remove the pinched pipes



WARNING

Any gas or oil remaining inside the stop valve may blow off the pinched piping.

Failure to observe the instructions in procedure below properly may result in property damage or personal injury, which may be serious depending on the circumstances.

Use the following procedure to remove the pinched piping:

- Remove the valve cover and make sure that the stop valves are fully closed.

6 Installation

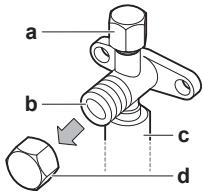

- a Service port and service port cover
- b Stop valve
- c Field piping connection
- d Stop valve cover

- 2 Connect the vacuuming/recovery unit through a manifold to the service port of all stop valves.

You have to recover gas and oil from all 4 pinched pipes. Depending on your available tools, use method 1 (manifold with refrigerant line splitters required) or method 2.

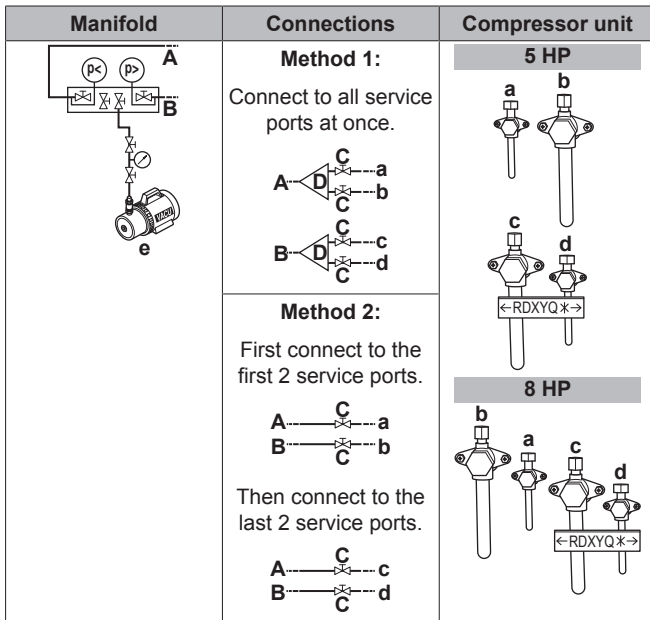

- a, b, c, d Service ports of stop valves
- e Vacuuming/recovery unit
- A, B, C Valves A, B and C
- D Refrigerant line splitter

- 3 Recover gas and oil from the pinched piping by using a recovery unit.

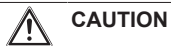

CAUTION

Do not vent gases into the atmosphere.

- 4 When all gas and oil is recovered from the pinched piping, disconnect the charge hose and close the service ports.
- 5 Cut off the lower part of the gas and liquid stop valve pipes along the black line. Use an appropriate tool (e.g. a pipe cutter, a pair of nippers).

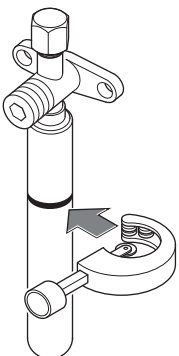

WARNING



Never remove the pinched piping by brazing.

Any gas or oil remaining inside the stop valve may blow off the pinched piping.

- 6 Wait until all oil is dripped out before continuing with the connection of the field piping in case the recovery was not complete.

6.5.7 To connect the refrigerant piping to the compressor unit



NOTICE

- Be sure to use the supplied accessory pipes when carrying out piping work in the field.
- Be sure that the field installed piping does not touch other pipes, the bottom panel or side panel.

- 1 Remove the service cover. See "6.2.2 To open the compressor unit" on page 17.

- 2 Choose a piping route (a or b).

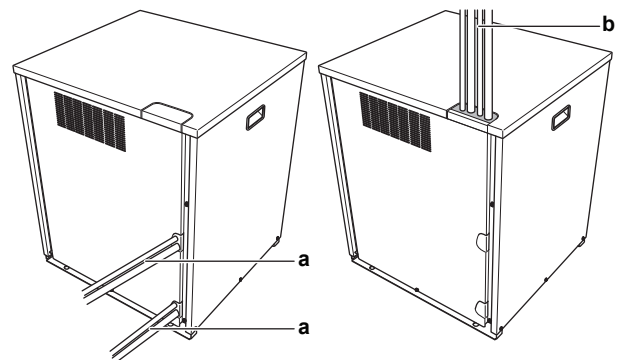

- a To the back
- b To the top

- 3 If you have chosen the piping route to the top:

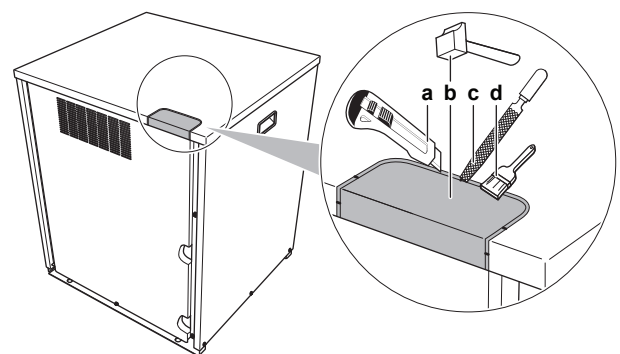

- a Cut the insulation (under the knockout hole).
- b Hit on the knockout hole, and remove it.
- c Remove the burrs.
- d Paint the edges and areas around the edges using repair paint to prevent rusting.

NOTICE

Precautions when making knockout holes:

- Avoid damaging the casing.
- After making the knockout holes, we recommend you remove the burrs and paint the edges and areas around the edges using repair paint to prevent rusting.
- When passing electrical wiring through the knockout holes, wrap the wiring with protective tape to prevent damage.

4 Connect piping (by brazing) as follows:

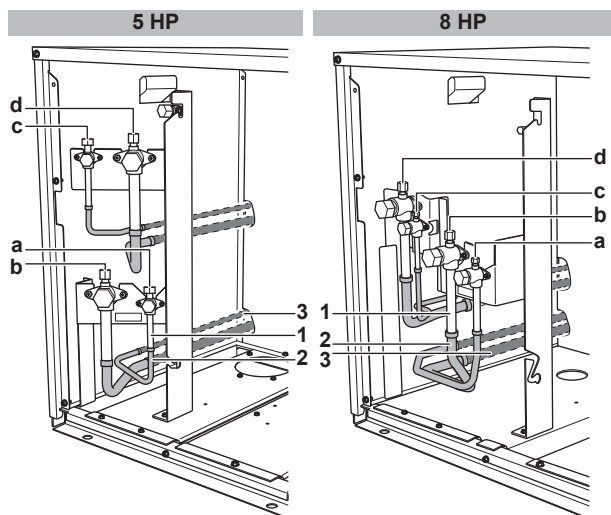

- a Liquid line (circuit 1: to heat exchanger unit)
- b Gas line (circuit 1: to heat exchanger unit)
- c Liquid line (circuit 2: to indoor units)
- d Gas line (circuit 2: to indoor units)
- 1 Pinched piping
- 2 Piping accessory
- 3 Field piping

- 5 Reattach the service cover.
- 6 Seal all gaps (example: a) to prevent small animals from entering the system.

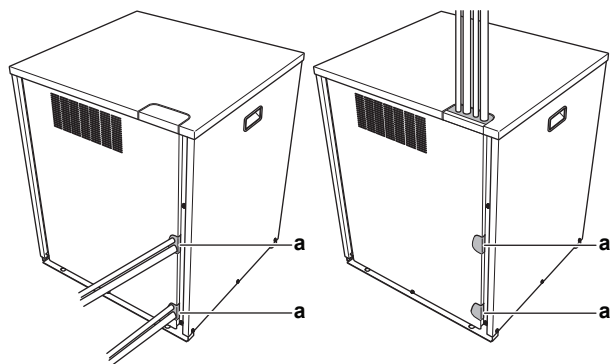

WARNING

Provide adequate measures to prevent that the unit can be used as a shelter by small animals. Small animals that make contact with electrical parts can cause malfunctions, smoke or fire.

6.5.8 To connect the refrigerant piping to the heat exchanger unit

- 1 Remove the cover.
- 2 Remove the 2 insulation pieces.
- 3 Put a wet cloth in front of the EPS to protect the drain pan.
- 4 Braze the liquid and gas piping.

NOTICE

Only for 8 HP.

Piping adapter (Ø19.1→22.2 mm) (delivered as accessory in the compressor unit). Use the piping adapter to connect the field piping (Ø22.2 mm) to the gas piping connection of the heat exchanger unit (Ø19.1 mm).



- 5 Remove the wet cloth.
- 6 Put back the 2 insulation pieces, peel off the insulation tapes and adhere them to the insulation pieces.
- 7 Reattach the cover.

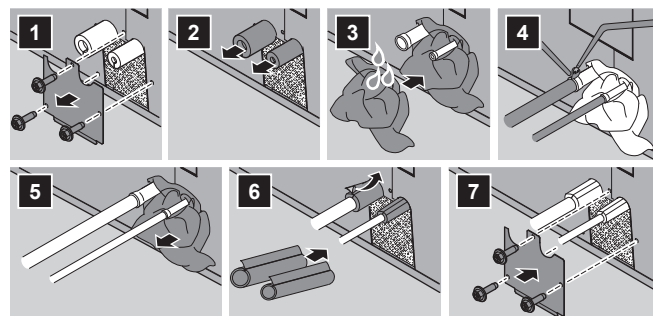
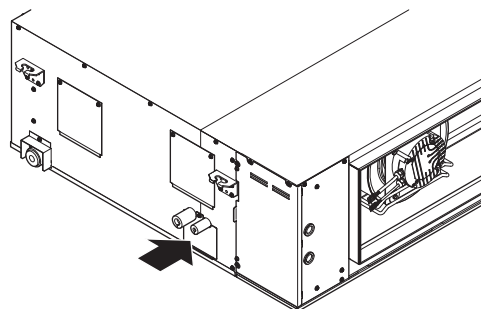

6.5.9 To connect the refrigerant branching kit

For installation of the refrigerant branching kit, refer to the installation manual delivered with the kit.

- Mount the refnet joint so that it branches either horizontally or vertically.
- Mount the refnet header so that it branches horizontally.

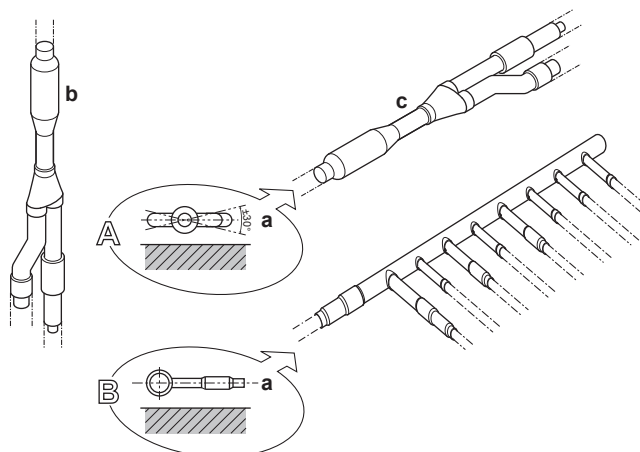

- a Horizontal surface
- b Refnet joint mounted vertically
- c Refnet joint mounted horizontally

6 Installation

6.6 Checking the refrigerant piping

6.6.1 About checking the refrigerant piping

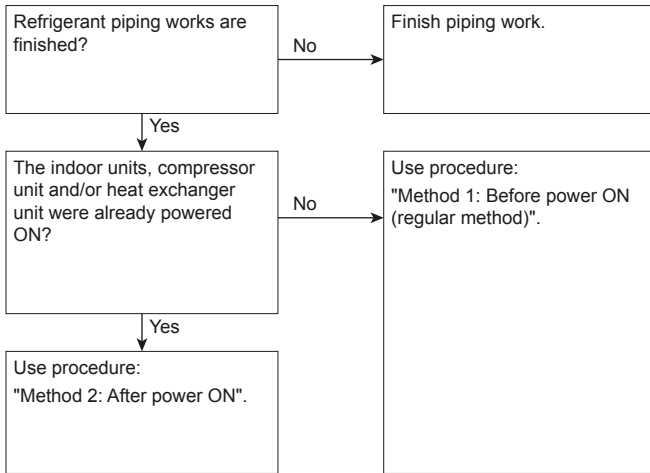

It is very important that all refrigerant piping work is done before the units (compressor unit, heat exchanger unit or indoor units) are powered on.

When the units are powered on, the expansion valves will initialise. This means that they will close. Leak test and vacuum drying of field piping, heat exchanger unit and indoor units is impossible when this happens.

Therefore, there will be explained 2 methods for initial installation, leak test and vacuum drying.

Method 1: Before power ON

If the system has not yet been powered on, no special action is required to perform the leak test and the vacuum drying.

Method 2: After power ON

If the system has already been powered on, activate setting [2-21] (refer to "7.2.4 To access mode 1 or 2" on page 34). This setting will open field expansion valves to guarantee a R410A piping pathway and make it possible to perform the leak test and the vacuum drying.

NOTICE

Make sure that the heat exchanger unit and all indoor units connected to the compressor unit are powered on.

NOTICE

Wait until the compressor unit has finished the initialisation to apply setting [2-21].

Leak test and vacuum drying

Checking the refrigerant piping involves:

- Checking for any leakages in the refrigerant piping.
- Performing vacuum drying to remove all moisture, air or nitrogen in the refrigerant piping.

If there is a possibility of moisture being present in the refrigerant piping (for example, water may have entered the piping), first carry out the vacuum drying procedure below until all moisture has been removed.

All piping inside the unit has been factory tested for leaks.

Only field installed refrigerant piping needs to be checked. Therefore, make sure that all the compressor unit stop valves are firmly closed before performing leak test or vacuum drying.

NOTICE

Make sure that all (field supplied) field piping valves are OPEN (not compressor unit stop valves!) before you start leak test and vacuuming.

For more information on the state of the valves, refer to "6.6.3 Checking refrigerant piping: Setup" on page 24.

6.6.2 Checking refrigerant piping: General guidelines

Connect the vacuum pump through a manifold to the service port of all stop valves to increase efficiency (refer to "6.6.3 Checking refrigerant piping: Setup" on page 24).

NOTICE

Use a 2-stage vacuum pump with a non-return valve or a solenoid valve that can evacuate to a gauge pressure of -100.7 kPa (5 Torr absolute).

NOTICE

Make sure the pump oil does not flow oppositely into the system while the pump is not working.

NOTICE

Do not purge the air with refrigerants. Use a vacuum pump to evacuate the installation.

6.6.3 Checking refrigerant piping: Setup

The system contains 2 refrigerant circuits:

- **Circuit 1:** Compressor unit → Heat exchanger unit
- **Circuit 2:** Compressor unit → Indoor units

You have to check both circuits (leak test, vacuuming drying). How to check depends on your available tools:

If you have a manifold...	Then
With refrigerant line splitters	You can check both circuits at once. To do so, connect the manifold via the splitters to both circuits, and check.
Without refrigerant line splitters (takes twice as long)	You have to check the circuits separately. To do so: <ul style="list-style-type: none"> • First connect the manifold to circuit 1, and check. • Then connect the manifold to circuit 2, and check.

Possible connections:

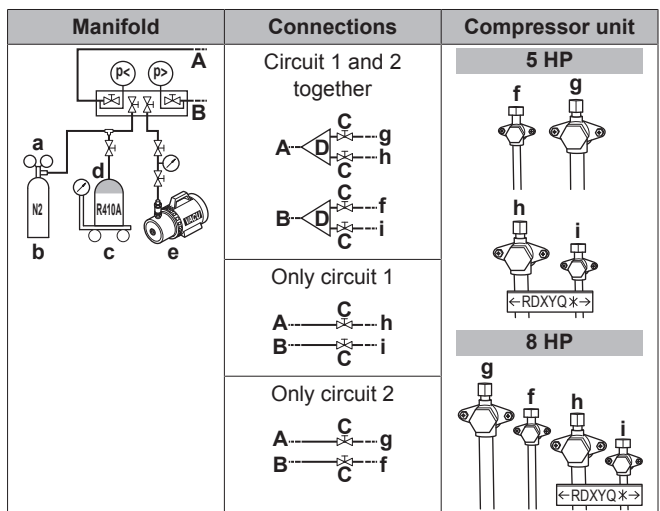

- a Pressure reducing valve
- b Nitrogen
- c Weighing scales
- d Refrigerant R410A tank (siphon system)
- e Vacuum pump
- f Liquid line stop valve (circuit 2: to indoor units)
- g Gas line stop valve (circuit 2: to indoor units)
- h Gas line stop valve (circuit 1: to heat exchanger unit)
- i Liquid line stop valve (circuit 1: to heat exchanger unit)
- A, B, C Valves A, B and C
- D Refrigerant line splitter

Valve	State of valve
Valves A, B and C	Open
Liquid line and gas line stop valves (f, g, h, i)	Close

**NOTICE**

The connections to the indoor units and to the heat exchanger unit, and all indoor units and the heat exchanger unit itself should also be leak and vacuum tested. Keep any possible (field supplied) field piping valves open as well.

Refer to the indoor unit installation manual for more details. Leak test and vacuum drying should be done before the power supply is set to the unit. If not, see also the flow chart earlier described in this chapter (see "6.6.1 About checking the refrigerant piping" on page 24).

6.6.4 To perform a leak test

The leak test must satisfy the specifications of EN378-2.

To check for leaks: Vacuum leak test

- 1 Evacuate the system from the liquid and gas piping to -100.7 kPa ($-1.007 \text{ bar/5 Torr}$) for more than 2 hours.
- 2 Once reached, turn off the vacuum pump and check that the pressure does not rise for at least 1 minute.
- 3 Should the pressure rise, the system may either contain moisture (see vacuum drying below) or have leaks.

To check for leaks: Pressure leak test

- 1 Break the vacuum by pressurising with nitrogen gas to a minimum gauge pressure of 0.2 MPa (2 bar). Never set the gauge pressure higher than the maximum operation pressure of the unit, i.e. 4.0 MPa (40 bar).
- 2 Test for leaks by applying a bubble test solution to all piping connections.
- 3 Discharge all nitrogen gas.

**NOTICE**

Make sure to use a recommended bubble test solution from your wholesaler. Do not use soap water, which may cause cracking of flare nuts (soap water may contain salt, which absorbs moisture that will freeze when the piping gets cold), and/or lead to corrosion of flared joints (soap water may contain ammonia which causes a corrosive effect between the brass flare nut and the copper flare).

6.6.5 To perform vacuum drying

**NOTICE**

The connections to the indoor units and to the heat exchanger unit, and all indoor units and the heat exchanger unit itself should also be leak and vacuum tested. Keep, if existing, all (field supplied) field valves to the indoor units and to the heat exchanger unit open as well.

Leak test and vacuum drying should be done before the power supply is set to the unit. If not, see "6.6.1 About checking the refrigerant piping" on page 24 for more information.

To remove all moisture from the system, proceed as follows:

- 1 Evacuate the system for at least 2 hours to a target vacuum of -100.7 kPa ($-1.007 \text{ bar/5 Torr}$).
- 2 Check that, with the vacuum pump turned off, the target vacuum is maintained for at least 1 hour.
- 3 Should you fail to reach the target vacuum within 2 hours or maintain the vacuum for 1 hour, the system may contain too much moisture. In that case, break the vacuum by pressurising with nitrogen gas to a gauge pressure of 0.05 MPa (0.5 bar) and repeat steps 1 to 3 until all moisture has been removed.
- 4 Depending on whether you want to immediately charge refrigerant through the refrigerant charge port or first pre-charge a portion of refrigerant through the liquid line, either open the compressor unit stop valves, or keep them closed. See "6.8.4 To charge refrigerant" on page 26 for more information.

**INFORMATION**

After opening the stop valve, it is possible that the pressure in the refrigerant piping does NOT increase. This might be caused by e.g. the closed state of the expansion valve in the compressor unit circuit, but does NOT present any problem for correct operation of the unit.

6.7 To insulate the refrigerant piping

After finishing the leak test and vacuum drying, the piping must be insulated. Take into account the following points:

- Make sure to insulate the connection piping and refrigerant branch kits entirely.
- Be sure to insulate the liquid and gas piping (for all units).
- Use heat resistant polyethylene foam which can withstand a temperature of 70°C for liquid piping and polyethylene foam which can withstand a temperature of 120°C for gas piping.
- Reinforce the insulation on the refrigerant piping according to the installation environment.

Ambient temperature	Humidity	Minimum thickness
$\leq 30^\circ\text{C}$	75% to 80% RH	15 mm
$> 30^\circ\text{C}$	$\geq 80\%$ RH	20 mm

Condensation might form on the surface of the insulation.

- If there is a possibility that condensation on the stop valve might drip down into the indoor unit or into the heat exchanger unit through gaps in the insulation and piping because the compressor unit is located higher than the indoor unit or higher than the heat exchanger unit, this must be prevented by sealing up the connections. See below figure.

6 Installation

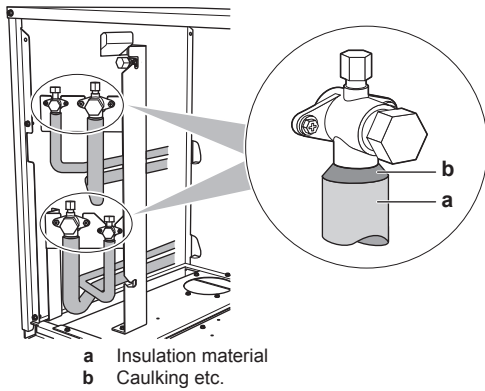

a Insulation material
b Caulking etc.

6.8 Charging refrigerant

6.8.1 About charging refrigerant

The compressor unit is factory charged with refrigerant, but depending on the field piping you have to charge additional refrigerant.

Before charging refrigerant

Make sure the compressor unit's **external** refrigerant piping is checked (leak test, vacuum drying).

Typical workflow

Charging additional refrigerant typically consists of the following stages:

- 1 Determining how much you have to charge additionally.
- 2 Charging additional refrigerant (pre-charging and/or manual charging).
- 3 Filling in the fluorinated greenhouse gases label, and fixing it to the inside of the compressor unit.

6.8.2 Precautions when charging refrigerant



INFORMATION

Also read the precautions and requirements in the following chapters:

- General safety precautions
- Preparation



WARNING

- Only use R410A as refrigerant. Other substances may cause explosions and accidents.
- R410A contains fluorinated greenhouse gases. Its global warming potential (GWP) value is 2087.5. Do NOT vent these gases into the atmosphere.
- When charging refrigerant, always use protective gloves and safety glasses.



NOTICE

If the power of some units is turned off, the charging procedure cannot be finished properly.



NOTICE

Be sure to turn on the power 6 hours before operation in order to have power running to the crankcase heater and to protect the compressor.



NOTICE

If operation is performed within 12 minutes after the compressor unit, heat exchanger unit and indoor units are turned on, the compressor will not operate before the communication is established in a correct way between the compressor unit, heat exchanger unit and indoor units.



NOTICE

Before starting charging procedures:

- In case of 5 HP: Check if the 7-LEDs display is as normal (see "7.2.4 To access mode 1 or 2" on page 34), and there is no malfunction code on the user interface of the indoor unit. If a malfunction code is present, see "11.3 Solving problems based on error codes" on page 46.
- In case of 8 HP: Check if the 7-segment display indication of the compressor unit A1P PCB is as normal (see "7.2.4 To access mode 1 or 2" on page 34). If a malfunction code is present, see "11.3 Solving problems based on error codes" on page 46.



NOTICE

Make sure all connected units (heat exchanger unit + indoor units) are recognised (setting [1-5]).

6.8.3 To determine the additional refrigerant amount

Additional refrigerant to be charged=R (kg). R should be rounded off in units of 0.1 kg.

$$R=[(X_1 \times \mathbf{\varnothing 12.7}) \times 0.12 + (X_2 \times \mathbf{\varnothing 9.5}) \times 0.059 + (X_3 \times \mathbf{\varnothing 6.4}) \times 0.022] \times A + B$$

$X_{1...3}$ = Total length (m) of liquid piping size at $\varnothing a$

Parameter A and B:

Model	Parameter A	Parameter B
RKXYQ5	0.8	3.1 kg
RKXYQ8	1.0	2.6 kg

Metric piping. When using metric piping, please take into account following table concerning the weight factor to be allocated. It should be substituted in the formula for R.

Inch piping		Metric piping	
Size (Ø) (mm)	Weight factor	Size (Ø) (mm)	Weight factor
6.4	0.022	6	0.018
9.5	0.059	10	0.065
12.7	0.12	12	0.097

6.8.4 To charge refrigerant

Charging refrigerant consists of 2 stages:

Stage	Description
Stage 1: Pre-charging	Recommended in case of larger systems. Can be skipped, but charging will take longer then.
Stage 2: Manual charging	Only necessary if the determined additional refrigerant amount is not reached yet by pre-charging.

Stage 1: Pre-charging

Summary – Pre-charging:

Refrigerant bottle	Connected to the service ports of the stop valves. Which stop valves to use depends on the circuits you choose to pre-charge to: <ul style="list-style-type: none"> • Circuits 1 and 2 together (manifold with refrigerant line splitters required). • First circuit 1, then circuit 2 (or vice versa). • Only circuit 1 • Only circuit 2
Stop valves	Closed
Compressor	Does NOT operate

- 1 Connect as shown (choose one of the possible connections). Make sure that all compressor unit stop valves, as well as valve A are closed.

Possible connections:

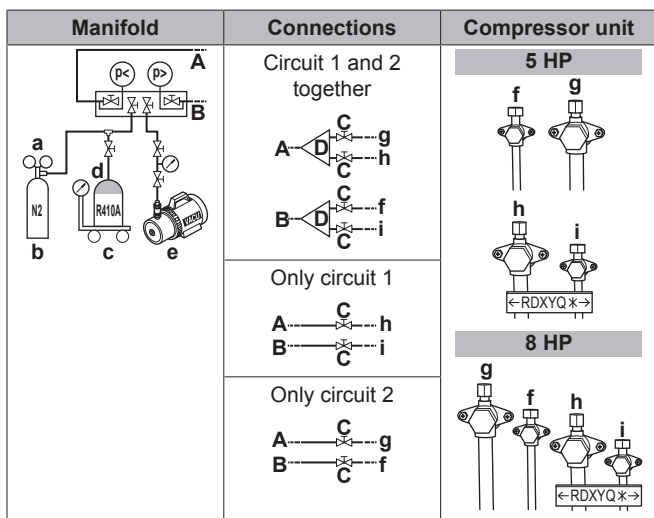

- a Pressure reducing valve
- b Nitrogen
- c Weighing scales
- d Refrigerant R410A tank (siphon system)
- e Vacuum pump
- f Liquid line stop valve (circuit 2: to indoor units)
- g Gas line stop valve (circuit 2: to indoor units)
- h Gas line stop valve (circuit 1: to heat exchanger unit)
- i Liquid line stop valve (circuit 1: to heat exchanger unit)
- A, B, C Valves A, B and C
- D Refrigerant line splitter

- 2 Open valves C (on line of B) and B.
- 3 Pre-charge refrigerant until the determined additional refrigerant amount is reached or pre-charging is not possible anymore, and then close valves C and B.
- 4 Do one of the following:

If	Then
The determined additional refrigerant amount is reached	Disconnect the manifold from the liquid line(s). You do not have to perform the "Stage 2" instructions.
Too much refrigerant is charged	Recover refrigerant until the determined additional refrigerant is reached. Disconnect the manifold from the liquid line(s). You do not have to perform the "Stage 2" instructions.
The determined additional refrigerant amount is not reached yet	Disconnect the manifold from the liquid line(s). Continue with the "Stage 2" instructions.

Stage 2: Manual charging

(= charging in the "Manual additional refrigerant charge" mode)

Summary – Manual charging:	
Refrigerant bottle	Connected to the service port for refrigerant charge. This charges to both circuits, and to the compressor unit's internal refrigerant piping.
Stop valves	Open
Compressor	Operates

- 5 Connect as shown. Make sure valve A is closed.

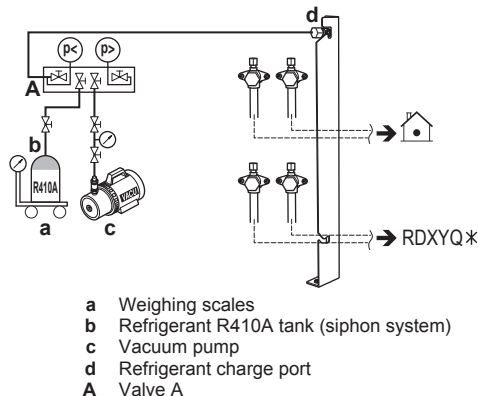

NOTICE

The refrigerant charging port is connected to the piping inside the unit. The unit's internal piping is already factory charged with refrigerant, so be careful when connecting the charge hose.

- 6 Open all compressor unit stop valves. At this point, valve A must remain closed!
- 7 Take all the precautions mentioned in "7 Configuration" on page 32 and "8 Commissioning" on page 42 into account.
- 8 Turn on the power of the indoor units, compressor unit and heat exchanger unit.
- 9 Activate setting [2-20] to start the manual additional refrigerant charge mode. For details, see "7.2.8 Mode 2: Field settings" on page 37.

Result: The unit will start operation.



INFORMATION

The manual refrigerant charge operation will automatically stop within 30 minutes. If charging is not completed after 30 minutes, perform the additional refrigerant charging operation again.



INFORMATION

- When a malfunction is detected during the procedure (e.g., in case of closed stop valve), a malfunction code will be displayed. In that case, refer to "6.8.5 Error codes when charging refrigerant" on page 28 and solve the malfunction accordingly. Resetting the malfunction can be done by pushing BS3. You can restart the "Charging" instructions.
- Aborting the manual refrigerant charge is possible by pushing BS3. The unit will stop and return to idle condition.

- 10 Open valve A.
- 11 Charge refrigerant until the remaining determined additional refrigerant amount is added, and then close valve A.
- 12 Press BS3 to stop the manual additional refrigerant charge mode.

6 Installation



NOTICE

Make sure to open all stop valves after (pre-) charging the refrigerant.

Operating with the stop valves closed will damage the compressor.



NOTICE

After adding the refrigerant, do not forget to close the lid of the refrigerant charging port. The tightening torque for the lid is 11.5 to 13.9 N•m.

6.8.5 Error codes when charging refrigerant



INFORMATION

If a malfunction occurs:

- In case of 5 HP: The error code is displayed on the user interface of the indoor unit.
- In case of 8 HP: The error code is displayed on the compressor unit's 7-segments display and on the user interface of the indoor unit.

If a malfunction occurs, close valve A immediately. Confirm the malfunction code and take corresponding action, "[11.3 Solving problems based on error codes](#)" on page 46.

6.8.6 To fix the fluorinated greenhouse gases label

- 1 Fill in the label as follows:

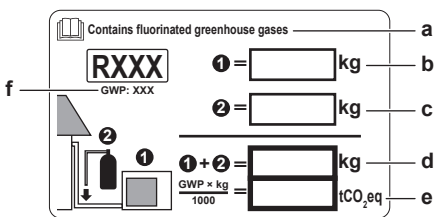

- a If a multilingual fluorinated greenhouse gases label is delivered with the unit (see accessories), peel off the applicable language and stick it on top of a.
- b Factory refrigerant charge: see unit name plate
- c Additional refrigerant amount charged
- d Total refrigerant charge
- e **Greenhouse gas emissions** of the total refrigerant charge expressed as tonnes CO₂-equivalent
- f GWP = Global warming potential



NOTICE

In Europe, the **greenhouse gas emissions** of the total refrigerant charge in the system (expressed as tonnes CO₂-equivalent) is used to determine the maintenance intervals. Follow the applicable legislation.

Formula to calculate the greenhouse gas emissions:
 $\text{GWP value of the refrigerant} \times \text{Total refrigerant charge [in kg]} / 1000$

- 2 Fix the label on the inside of the compressor unit. There is a dedicated place for it on the wiring diagram label.

6.9 Connecting the electrical wiring

6.9.1 About connecting the electrical wiring

Typical workflow

Connecting the electrical wiring typically consists of the following stages:

- 1 Making sure the power supply system complies with the electrical specifications of the units.
- 2 Connecting the electrical wiring to the compressor unit.
- 3 Connecting the electrical wiring to the heat exchanger unit.
- 4 Connecting the electrical wiring to the indoor units.
- 5 Connecting the main power supply.

Field wiring: Overview

Field wiring consists of:

- Power supply (always including earth)
- Communication (= transmission) wiring between the compressor unit, the heat exchanger unit, and the indoor units.

Example:

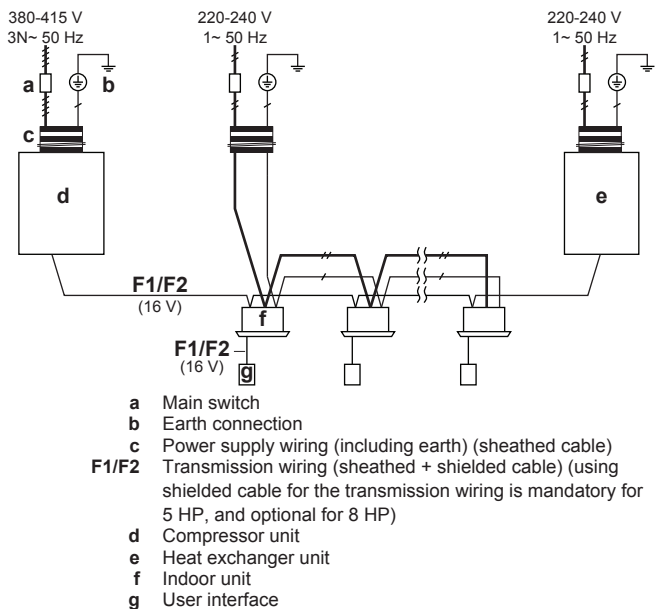

Power supply wiring and transmission wiring

It is important to keep the power supply and the transmission wiring separated from each other. In order to avoid any electrical interference the distance between both wiring should always be at least 50 mm.



NOTICE

- Be sure to keep the power line and transmission line apart from each other. Transmission wiring and power supply wiring may cross, but may not run parallel.
- Transmission wiring and power supply wiring may not touch internal piping in order to avoid wire damage due to high temperature piping.
- Firmly close the lid and arrange the electrical wires so as to prevent the lid or other parts from coming loose.

The transmission wiring outside the unit should be wrapped and routed together with the field piping.

Branches

Maximum number of branches for unit-to-unit cabling	16
---	----

Transmission wiring	Sheathed + shielded cable (2 wires) Vinyl cords 0.75~1.25 mm ² (using shielded cable for the transmission wiring is mandatory for 5 HP, and optional for 8 HP)
Maximum wiring length (= distance between compressor unit and furthest indoor unit)	300 m
Total wiring length (= distance between compressor unit and all indoor units, and between compressor unit and heat exchanger unit)	600 m

If the total transmission wiring exceeds these limits, it may result in communication error.

No branching is allowed after branching.

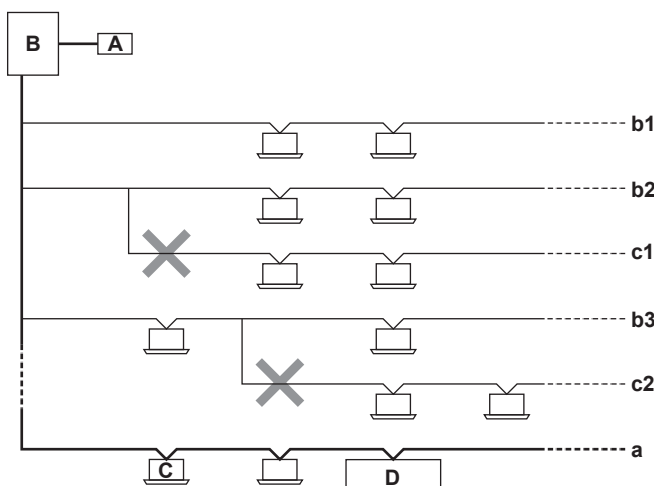

- A Central user interface (etc...)
- B Compressor unit
- C Indoor unit
- D Heat exchanger unit
- a Main line. The main line is the line to which the transmission wiring of the heat exchanger unit is connected.
- b1, b2, b3 Branch lines
- c1, c2 No branch is allowed after branch

6.9.2 Precautions when connecting electrical wiring



DANGER: RISK OF ELECTROCUTION



WARNING

All field wiring and components must be installed by a licensed electrician and must comply with the applicable legislation.



WARNING

If NOT factory installed, a main switch or other means for disconnection, having a contact separation in all poles providing full disconnection under overvoltage category III condition, shall be installed in the fixed wiring.



WARNING

- ONLY use copper wires.
- Make sure the field wiring complies with the applicable legislation.
- All field wiring must be performed in accordance with the wiring diagram supplied with the product.
- NEVER squeeze bundled cables and make sure they do not come in contact with the piping and sharp edges. Make sure no external pressure is applied to the terminal connections.
- Make sure to install earth wiring. Do NOT earth the unit to a utility pipe, surge absorber, or telephone earth. Incomplete earth may cause electrical shock.
- Make sure to use a dedicated power circuit. NEVER use a power supply shared by another appliance.
- Make sure to install the required fuses or circuit breakers.
- Make sure to install an earth leakage protector. Failure to do so may cause electric shock or fire.
- When installing the earth leakage protector, make sure it is compatible with the inverter (resistant to high frequency electric noise) to avoid unnecessary opening of the earth leakage protector.

Install power cables at least 1 metre away from televisions or radios to prevent interference. Depending on the radio waves, a distance of 1 metre may not be sufficient.



WARNING

- After finishing the electrical work, confirm that each electrical component and terminal inside the electrical components box is connected securely.
- Make sure all covers are closed before starting up the unit.



NOTICE

Do not operate the unit until the refrigerant piping is complete. Running the unit before the piping is ready will break the compressor.



NOTICE

If the power supply has a missing or wrong N-phase, equipment will break down.



NOTICE

Do NOT install a phase advancing capacitor, because this unit is equipped with an inverter. A phase advancing capacitor will reduce performance and may cause accidents.



NOTICE

Never remove a thermistor, sensor, etc., when connecting power wiring and transmission wiring. (If operated without thermistor, sensor, etc., the compressor may break down.)



NOTICE

- The reversed phase protection detector of this product only functions when the product starts up. Consequently reversed phase detection is not performed during normal operation of the product.
- The reversed phase protection detector is designed to stop the product in the event of an abnormality when the product is started up.
- Replace two of the three phases (L1, L2, and L3) during reverse-phase protection abnormality.

6 Installation

6.9.3 Guidelines when connecting the electrical wiring

Keep the following in mind:

- If stranded conductor wires are being used, install a round crimp-style terminal on the tip. Place the round crimp-style terminal on the wire up to the covered part and fasten the terminal with the appropriate tool.

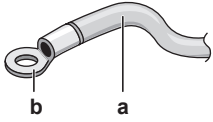

a Stranded conductor wire
b Round crimp-style terminal

- Use the following methods for installing wires:

Wire type	Installation method
Single core wire	<p>a Curled single core wire b Screw c Flat washer</p>
Stranded conductor wire with round crimp-style terminal	<p>a Terminal b Screw c Flat washer</p>

Tightening torques

Wiring	Screw size	Tightening torque (N·m)
Power supply wiring (power supply + shielded ground)	M5	2.0~3.0
Transmission wiring	M3.5	0.8~0.97

6.9.4 To connect the electrical wiring on the compressor unit

NOTICE

- Follow the wiring diagram (delivered with the unit, located on the switch box cover).
- Make sure the electrical wiring does NOT obstruct proper reattachment of the service cover.

- Remove the service covers of the compressor unit and the switch box. See "6.2.2 To open the compressor unit" on page 17.
- Connect the transmission wiring as follows:

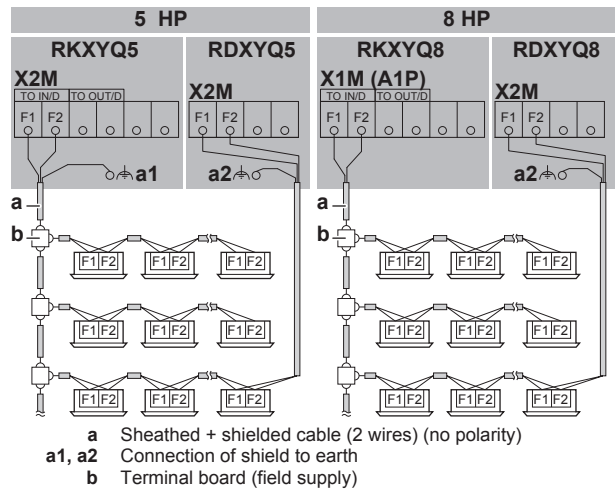

WARNING

Shielded cable. Using shielded cable for the transmission wiring is mandatory for 5 HP, and optional for 8 HP.

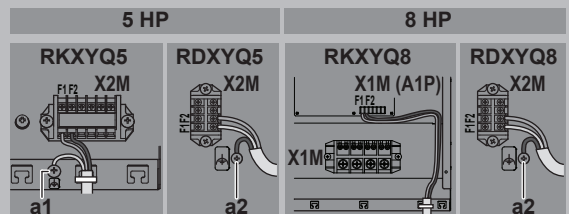

When using shielded cable:

- In case of 5 HP (a1 and a2): Connect the shield to the earth of the compressor unit and the heat exchanger unit.
- In case of 8 HP (only a2): Connect the shield only to the earth of the heat exchanger unit.

- Connect the power supply as follows:

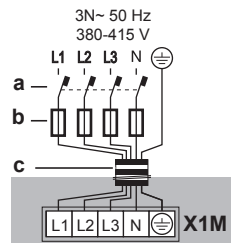

- Route the wiring through the frame, and fix the cables (power supply and transmission wiring) with cable ties.



INFORMATION

To make routing the wiring easier, you can turn the switch box horizontally by loosening the screw on the left side of the switch box.

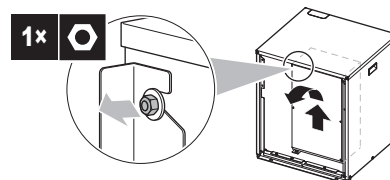

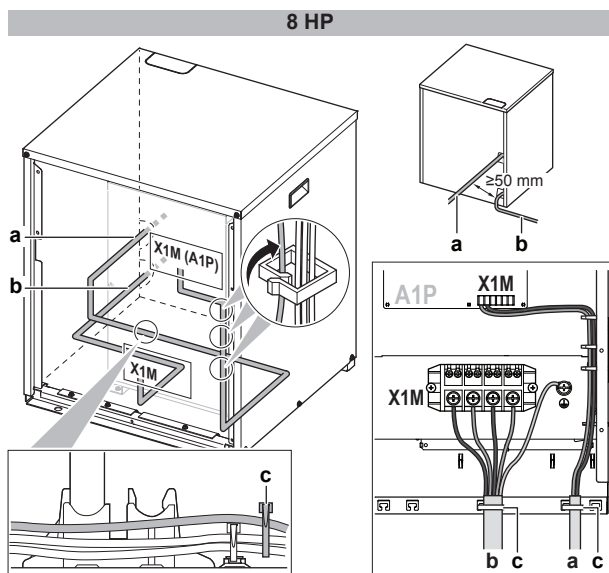
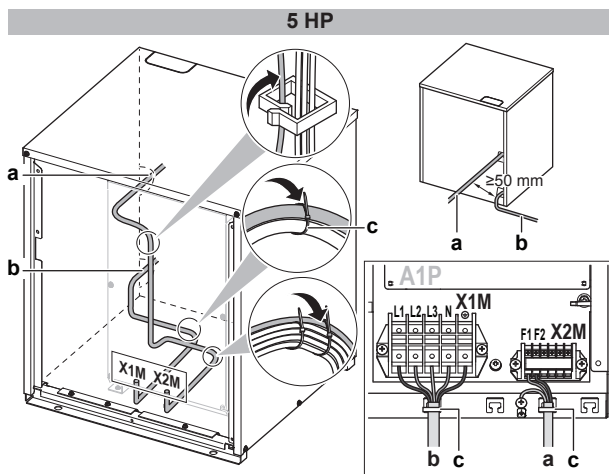

a Transmission wiring
b Power supply
c Cable tie

- Reattach the service covers. See "6.10.2 To close the compressor unit" on page 32.
- Connect an earth leakage circuit breaker and fuse to the power supply line.

6.9.5 To connect the electrical wiring on the heat exchanger unit



NOTICE

- Follow the wiring diagram (delivered with the unit, located at the inside of the service cover).
- Make sure the electrical wiring does NOT obstruct proper reattachment of the service cover.

- Remove the service cover. See "6.2.3 To open the switch box cover of the heat exchanger unit" on page 17.
- Connect the transmission wiring as follows:

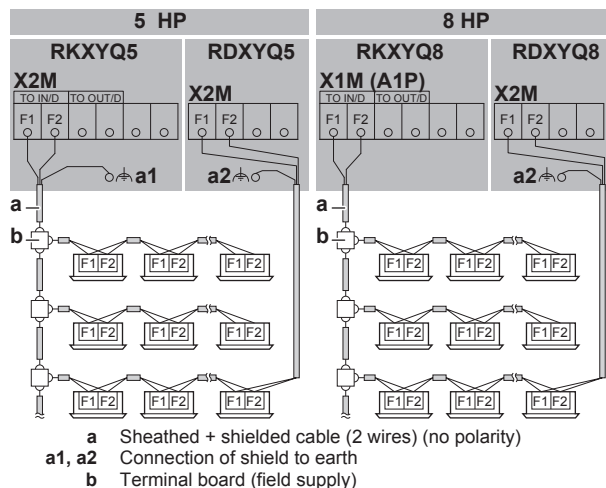

a Sheathed + shielded cable (2 wires) (no polarity)
a1, a2 Connection of shield to earth
b Terminal board (field supply)



WARNING

Shielded cable. Using shielded cable for the transmission wiring is mandatory for 5 HP, and optional for 8 HP.

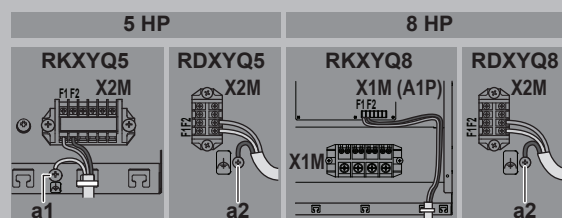

a1, a2 Earth (use the screw delivered as accessory)

When using shielded cable:

- In case of 5 HP (a1 and a2): Connect the shield to the earth of the compressor unit and the heat exchanger unit.
- In case of 8 HP (only a2): Connect the shield only to the earth of the heat exchanger unit.

- Connect the power supply as follows:

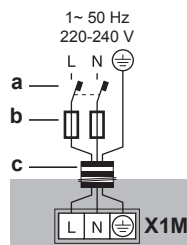

a Earth leakage circuit breaker
b Fuse
c Power supply cable

- Route the wiring through the frame, and fix the cables (power supply and transmission wiring) with cable ties.

7 Configuration

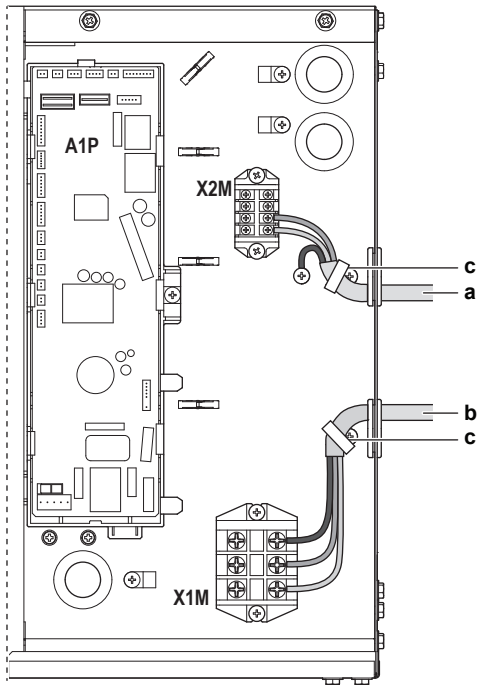

- a Transmission wiring
- b Power supply
- c Cable tie

6.10 Finishing the compressor unit installation

6.10.1 To finish the transmission wiring

After installing the transmission wires inside the unit, wrap them along with the on-site refrigerant pipes using finishing tape, as shown in figure below.

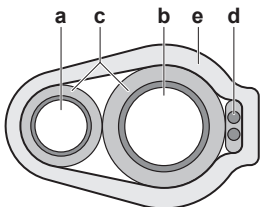

- a Liquid pipe
- b Gas pipe
- c Insulator
- d Transmission wiring (F1/F2)
- e Finishing tape

6.10.2 To close the compressor unit

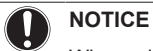

NOTICE

When closing the cover, make sure that the tightening torque does NOT exceed 4.1 N•m.

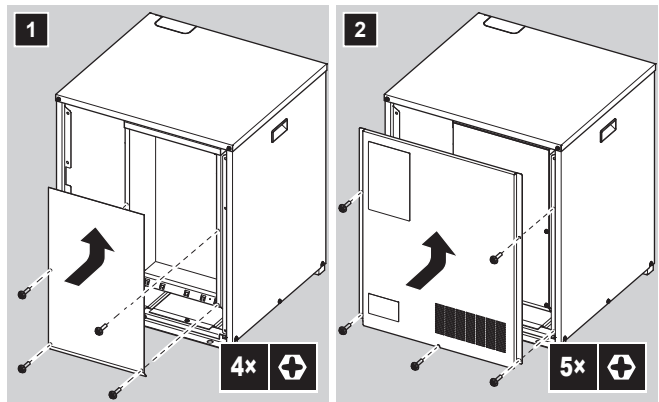

6.11 Finishing the heat exchanger unit installation

6.11.1 To close the heat exchanger unit



NOTICE

When closing the cover, make sure that the tightening torque does NOT exceed 4.1 N•m.

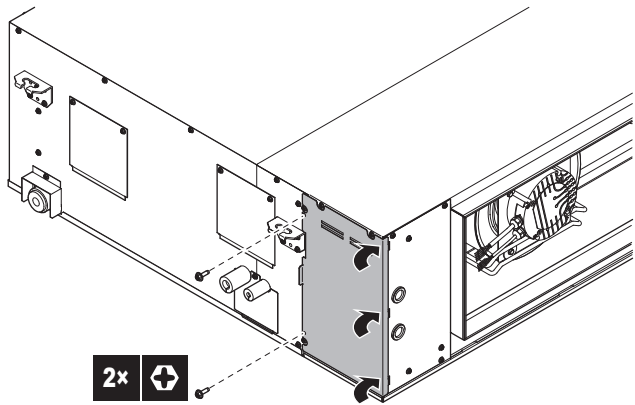

7 Configuration

7.1 Overview: Configuration

This chapter describes what you have to do and know to configure the system after it is installed.

It contains information about:

- Making field settings
- Energy saving and optimum operation



INFORMATION

It is important that all information in this chapter is read sequentially by the installer and that the system is configured as applicable.



DANGER: RISK OF ELECTROCUTION

7.2 Making field settings

7.2.1 About making field settings

To configure the heat pump system, you must give input to the compressor unit's main PCB (A1P). This involves the following field setting components:

- Push buttons to give input to the PCB
- A display to read feedback from the PCB
- DIP switches (only change the factory settings if you install a cool/heat selector switch).

Field settings are defined by their mode, setting and value. Example: [2-8]=4.

PC configurator

You can also make field settings through a personal computer interface (for this, option EKPCAB is required). The installer can prepare the configuration (off-site) on PC and afterwards upload the configuration to the system.

See also: "7.2.9 To connect the PC configurator to the compressor unit" on page 40.

Mode 1 and 2

Mode	Description
Mode 1 (monitoring settings)	Mode 1 can be used to monitor the current situation of the compressor unit. Some field setting contents can be monitored as well.
Mode 2 (field settings)	Mode 2 is used to change the field settings of the system. Consulting the current field setting value and changing the current field setting value is possible. In general, normal operation can be resumed without special intervention after changing field settings. Some field settings are used for special operation (e.g., 1 time operation, recovery/vacuuming setting, manual adding refrigerant setting, etc.). In such a case, it is required to abort the special operation before normal operation can restart. It will be indicated in below explanations.

7.2.2 To access the field setting components

See "6.2.2 To open the compressor unit" on page 17.

7.2.3 Field setting components

The components to make field settings differ depending on the model.

Model	Field setting components
5 HP	<ul style="list-style-type: none"> • Push buttons (BS1~BS5) • 7-LEDs display (H1P~H7P) • H8P: LED for indication during initialisation • DIP switches (DS1)
8 HP	<ul style="list-style-type: none"> • Push buttons (BS1~BS3) • 7-segments display (A1P) • DIP switches (DS1 and DS2)

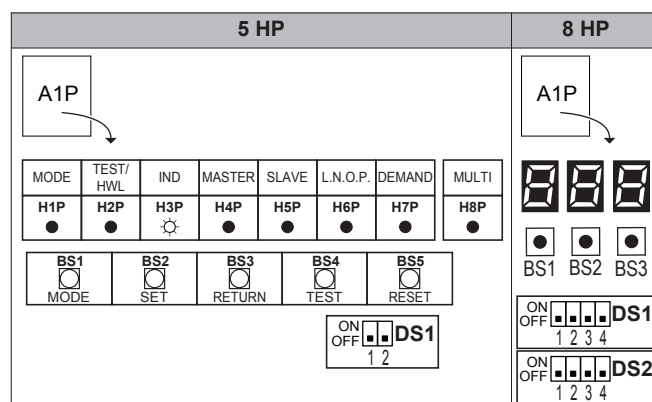

ON (☼) OFF (●) Flashing (⚡)
ON (☼) OFF (●) Flashing (⚡)

DIP switches

Only change the factory settings if you install a cool/heat selector switch.

Model	DIP switch
5 HP	<ul style="list-style-type: none"> • DS1-1: COOL/HEAT selector (refer to the manual of the cool/heat selector switch). OFF=not installed=factory setting • DS1-2: NOT USED. DO NOT CHANGE THE FACTORY SETTING.
8 HP	<ul style="list-style-type: none"> • DS1-1: COOL/HEAT selector (see "4.5.3 Possible options for the compressor unit and heat exchanger unit" on page 11). OFF=not installed=factory setting • DS1-2~4: NOT USED. DO NOT CHANGE THE FACTORY SETTING. • DS2-1~4: NOT USED. DO NOT CHANGE THE FACTORY SETTING.

Push buttons

Use the push buttons to make the field settings. Operate the push buttons with an insulated stick (such as a closed ball-point pen) to avoid touching of live parts.



The push buttons differ depending on the model.

Model	Push buttons
5 HP	<ul style="list-style-type: none"> • BS1: MODE: For changing the set mode • BS2: SET: For field setting • BS3: RETURN: For field setting • BS4: TEST: For test operation • BS5: RESET: For resetting the address when the wiring is changed or when an additional indoor unit is installed
8 HP	<ul style="list-style-type: none"> • BS1: MODE: For changing the set mode • BS2: SET: For field setting • BS3: RETURN: For field setting

7-LEDs display











The display gives feedback about the field settings, which are defined as [Mode-Setting]=Value.

The display differs depending on the model.

7 Configuration

Model	Display
5 HP	7-LEDs display: <ul style="list-style-type: none"> H1P: Shows the mode H2P~H7P: Shows the settings and values, represented in binary code (H8P: NOT used for field settings, but used during initialisation)
8 HP	7-segments display ()

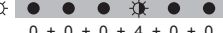
Example:

[H1P- 32 + 16 + 8 + 4 + 2 + 1] H1P H2P H3P H4P H5P H6P H7P		Description
		Default situation
		Mode 1
		Mode 2
 0 + 0 + 8 + 0 + 0 + 0		Setting 8 (in mode 2)
 0 + 0 + 0 + 4 + 0 + 0		Value 4 (in mode 2)

7.2.4 To access mode 1 or 2

After the units are turned ON, the display goes to its default situation. From there, you can access mode 1 and mode 2.

Initialisation: default situation

NOTICE

Be sure to turn on the power 6 hours before operation in order to have power running to the crankcase heater and to protect the compressor.

Turn on the power supply of the compressor unit, heat exchanger unit, and all indoor units. When the communication between the compressor unit, heat exchanger unit, and indoor units is established and normal, the display indication state will be as below (default situation when shipped from factory).

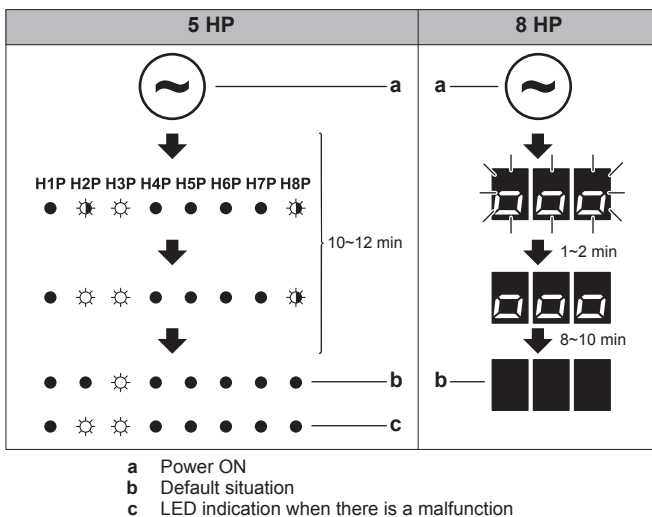

If the default situation is not displayed after 10~12 minutes, check the malfunction code on the indoor unit user interface (and in case of 8 HP on the compressor unit 7-segment display). Solve the malfunction code accordingly. First, check the communication wiring.

Switching between modes

Use BS1 to switch between the default situation, mode 1 and mode 2.

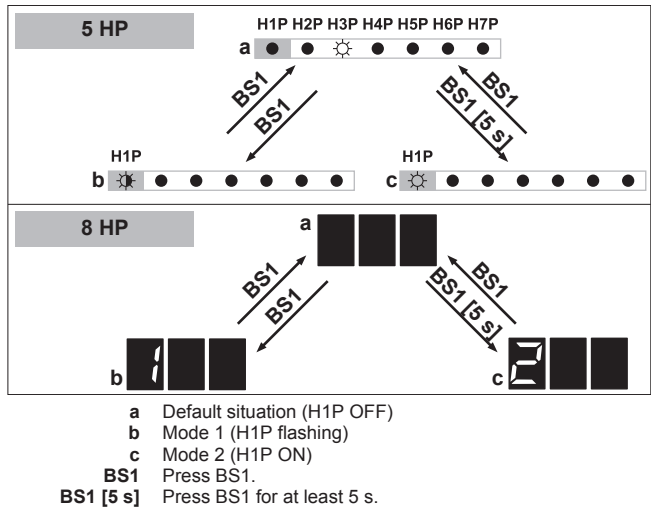

INFORMATION

If you get confused in the middle of the process, press BS1 to return to the default situation.

7.2.5 To use mode 1 (and default situation)

In mode 1 (and in default situation) you can read out some information. How to do this differs depending on the model.

Example: 7-LEDs display – Default situation

(in case of 5 HP)

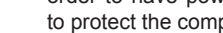
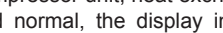

You can read out the status of low noise operation as follows:

#	Action	Button/display
1	Make sure the LEDs are showing the default situation.	H1P H2P H3P H4P H5P H6P H7P  (H1P OFF)
2	Check the status of LED H6P.	 H6P OFF: Unit is currently not operating under low noise restrictions.  H6P ON: Unit is currently operating under low noise restrictions.

Example: 7-LEDs display – Mode 1

(in case of 5 HP)

You can read out setting [1-5] (= the total number of connected units (heat exchanger unit + indoor units)) as follows:

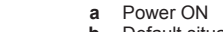
#	Action	Button/display
1	Start from the default situation.	H1P H2P H3P H4P H5P H6P H7P 
2	Select mode 1.	BS1 [1×] 
3	Select setting 5. ("X" depends on the setting that you want to select.)	BS2 [X×]  (= binary 5)

#	Action	Button/display
4	Display the value of setting 5. (there are 8 units connected)	 BS3 [1×] (= binary 8)
5	Quit mode 1.	 BS1 [1×]

Example: 7-segments display – Mode 1

(in case of 8 HP)

You can read out setting [1-10] (= the total number of connected units (heat exchanger unit + indoor units)) as follows:

#	Action	Button/display
1	Start from the default situation.	
2	Select mode 1.	 BS1 [1×]
3	Select setting 10. ("X" depends on the setting that you want to select.)	 BS2 [X×]
4	Display the value of setting 10. (there are 8 units connected)	 BS3 [1×]
5	Quit mode 1.	 BS1 [1×]

7.2.6 To use mode 2

In mode 2 you can make field settings to configure the system. How to do this differs slightly depending on the model.

Example: 7-LEDs display – Mode 2

(in case of 5 HP)

You can change the value of setting [2-8] (= T_e target temperature during cooling operation) to 4 (= 8°C) as follows:

#	Action	Button/display
1	Start from the default situation.	H1P H2P H3P H4P H5P H6P H7P
2	Select mode 2.	 BS1 [5 s]
3	Select setting 8. ("X" depends on the setting that you want to select.)	 BS2 [X×] (= binary 8)
4	Select value 4 (= 8°C). a: Display the current value. b: Change to 4. ("X" depends on the current value, and the value that you want to select.) c: Enter the value in the system. d: Confirm. The system starts operating according to the setting.	a) BS3 [1×] b) BS2 [X×] c) BS3 [1×] d) BS3 [1×]
5	Quit mode 2.	 BS1 [1×]

Example: 7-segments display – Mode 2

(in case of 8 HP)

You can change the value of setting [2-8] (= T_e target temperature during cooling operation) to 4 (= 8°C) as follows:

#	Action	Button/display
1	Start from the default situation.	
2	Select mode 2.	 BS1 [5 s]
3	Select setting 8. ("X" depends on the setting that you want to select.)	 BS2 [X×]
4	Select value 4 (= 8°C). a: Display the current value. b: Change to 4. ("X" depends on the current value, and the value that you want to select.) c: Enter the value in the system. d: Confirm. The system starts operating according to the setting.	a) BS3 [1×] b) BS2 [X×] c) BS3 [1×] d) BS3 [1×]
5	Quit mode 2.	 BS1 [1×]

7.2.7 Mode 1 (and default situation): Monitoring settings

In mode 1 (and in default situation) you can read out some information. What you can read out differs depending on the model.



7-LEDs display – Default situation (H1P OFF)

(in case of 5 HP)

You can read out the following information:

	Value / Description
H6P	Shows the status of low noise operation.
	OFF Unit is currently not operating under low noise restrictions.
	ON Unit is currently operating under low noise restrictions.
	Low noise operation reduces the sound generated by the unit compared to nominal operating conditions. Low noise operation can be set in mode 2. There are two methods to activate low noise operation of the compressor unit and heat exchanger unit. <ul style="list-style-type: none"> The first method is to enable an automatic low noise operation during night time by field setting. The unit will operate at the selected low noise level during the selected time frames. The second method is to enable low noise operation based on an external input. For this operation an optional accessory is required.





7 Configuration

Value / Description	
H7P	Shows the status of power consumption limitation operation.
OFF	 <p>Unit is currently not operating under power consumption limitations.</p>
ON	 <p>Unit is currently operating under power consumption limitation.</p>
<p>Power consumption limitation reduces the power consumption of the unit compared to nominal operating conditions.</p> <p>Power consumption limitation can be set in mode 2. There are two methods to activate power consumption limitation of the compressor unit.</p> <ul style="list-style-type: none"> The first method is to enable a forced power consumption limitation by field setting. The unit will always operate at the selected power consumption limitation. The second method is to enable power consumption limitation based on an external input. For this operation an optional accessory is required. 	

7-LEDs display – Mode 1 (H1P flashing)

(in case of 5 HP)

You can read out the following information:

Setting (H1P H2P H3P H4P H5P H6P H7P)	Value / Description
[1-5] 	It can be convenient to check if the total number of units which are installed (heat exchanger unit + indoor units) match the total number of units which are recognised by the system. In case there is a mismatch, it is advised to check the communication wiring path between compressor unit and heat exchanger unit, and between compressor unit and indoor units (F1/F2 communication line).
[1-14] 	When the latest malfunction codes were reset by accident on an indoor unit user interface, they can be checked again through this monitoring settings.
[1-15] 	Shows the 2nd last malfunction code. For the content or reason behind the malfunction code see "11.3 Solving problems based on error codes" on page 46 , where most relevant malfunction codes are explained. Detailed information about malfunction codes can be consulted in the service manual of this unit.
[1-16] 	To obtain more detailed information about the malfunction code, press BS2 up to 3 times.

7-segments display – Mode 1

(in case of 8 HP)

You can read out the following information:

Setting	Value / Description	
[1-1]	0	Unit is currently not operating under low noise restrictions.
Shows the status of low noise operation.	1	Unit is currently operating under low noise restrictions.
	<p>Low noise operation reduces the sound generated by the unit compared to nominal operating conditions.</p> <p>Low noise operation can be set in mode 2. There are two methods to activate low noise operation of the compressor unit and heat exchanger unit.</p> <ul style="list-style-type: none"> The first method is to enable an automatic low noise operation during night time by field setting. The unit will operate at the selected low noise level during the selected time frames. The second method is to enable low noise operation based on an external input. For this operation an optional accessory is required. 	
[1-2]	0	Unit is currently not operating under power consumption limitations.
Shows the status of power consumption limitation operation.	1	Unit is currently operating under power consumption limitation.
	<p>Power consumption limitation reduces the power consumption of the unit compared to nominal operating conditions.</p> <p>Power consumption limitation can be set in mode 2. There are two methods to activate power consumption limitation of the compressor unit.</p> <ul style="list-style-type: none"> The first method is to enable a forced power consumption limitation by field setting. The unit will always operate at the selected power consumption limitation. The second method is to enable power consumption limitation based on an external input. For this operation an optional accessory is required. 	
[1-5]	For more information, see setting [2-8].	
Shows the current T_e target parameter position.		
[1-6]	For more information, see setting [2-9].	
Shows the current T_c target parameter position.		
[1-10]	It can be convenient to check if the total number of units which are installed (heat exchanger unit + indoor units) match the total number of units which are recognised by the system. In case there is a mismatch, it is advised to check the communication wiring path between compressor unit and heat exchanger unit, and between compressor unit and indoor units (F1/F2 communication line).	
Shows the total number of connected units (heat exchanger unit + indoor units).		

Setting	Value / Description
[1-17] Shows the latest malfunction code.	When the latest malfunction codes were reset by accident on an indoor unit user interface, they can be checked again through this monitoring settings.
[1-18] Shows the 2nd last malfunction code.	For the content or reason behind the malfunction code see "11.3 Solving problems based on error codes" on page 46, where most relevant malfunction codes are explained. Detailed information about malfunction codes can be consulted in the service manual of this unit.
[1-19] Shows the 3rd last malfunction code.	

Setting	Value / Description
[1-40] Shows the current cooling comfort setting.	For more information, see setting [2-81].
[1-41] Shows the current heating comfort setting.	For more information, see setting [2-82].























7.2.8 Mode 2: Field settings

In mode 2 you can make field settings to configure the system. The display and the settings differ depending on the model.









































Model	Display	Setting/value
5 HP	H1P H2P H3P H4P H5P H6P H7P 7-LEDs display	The seven LEDs give a binary representation of the setting/value number.
8 HP	888 7-segments display	The three 7-segments show the setting/value number.























For more information and advice about the impact of the following settings, see "7.3 Energy saving and optimum operation" on page 40:

- In case of 5 HP: settings [2-8], [2-9], [2-41] and [2-42]
- In case of 8 HP: settings [2-8], [2-9], [2-81] and [2-82]

Setting	Value		Description
	 (8 HP)	H1P H2P H3P H4P H5P H6P H7P (5 HP)	
[2-8]  T _e target temperature during cooling operation.	0 (default)	 (default)	Auto
	2		6°C
	3		7°C
	4		8°C
	5		9°C
	6		10°C
	7		11°C
[2-9]  T _c target temperature during heating operation.	0 (default)	 (default)	Auto
	1		41°C
	3		43°C
	6		46°C
[2-12]  Enable the low noise function and/or power consumption limitation via external control adaptor (DTA104A61/62). If the system needs to be running under low noise operation or under power consumption limitation conditions when an external signal is sent to the unit, this setting should be changed. This setting will only be effective when the optional external control adaptor (DTA104A61/62) is installed in the indoor unit.	0 (default)	 (= binary 1) (default)	Deactivated.
	1	 (= binary 2)	Activated.
[2-15]  Fan static pressure setting (in heat exchanger unit). You can set the external static pressure of the heat exchanger unit according to the ducting requirements.	0		30 Pa
	1 (default)	 (default)	60 Pa
	2		90 Pa
	3		120 Pa
	4		150 Pa

7 Configuration

Setting	Value		
	 (8 HP)	H1P H2P H3P H4P H5P H6P H7P (5 HP)	Description
[2-16]  ●  ● ● ● ● ● ●	0 (default)	—	Deactivated.
Test run heat exchanger unit. When activated, the heat exchanger fans start running. This allows you to check the ducting with a running heat exchanger unit.	1	—	Activated.
[2-20]  ●  ●  ● ● ● ● ● ●	0 (default)	 ● ● ● ● ● ● ● ● (= binary 1) (default)	Deactivated.
Manual additional refrigerant charge. In order to add the additional refrigerant charge amount in a manual way (without automatic refrigerant charging functionality), following setting should be applied.	1	 ● ● ● ● ● ● ● ● (= binary 2)	Activated. To stop the manual additional refrigerant charge operation (when the required additional refrigerant amount is charged), push BS3. If this function was not aborted by pushing BS3, the unit will stop its operation after 30 minutes. If 30 minutes was not sufficient to add the needed refrigerant amount, the function can be reactivated by changing the field setting again.
[2-21]  ●  ●  ● ● ● ● ● ●	0 (default)	 ● ● ● ● ● ● ● ● (= binary 1) (default)	Deactivated.
Refrigerant recovery/vacuumping mode. In order to achieve a free pathway to reclaim refrigerant out of the system or to remove residual substances or to vacuum the system it is necessary to apply a setting which will open required valves in the refrigerant circuit so the reclaim of refrigerant or vacuumping process can be done properly.	1	 ● ● ● ● ● ● ● ● (= binary 2)	Activated. To stop the refrigerant recovery/vacuumping mode, push BS1 (in case of 5 HP) or BS3 (in case of 8 HP). If it is not pushed, the system will remain in refrigerant recovery/vacuumping mode.
[2-22]  ●  ●  ●  ● ●	0 (default)	 ● ● ● ● ● ● ● ● (default)	Deactivated
Automatic low noise setting and level during night time. By changing this setting, you activate the automatic low noise operation function of the unit and define the level of operation. Depending on the chosen level, the noise level will be lowered. The start and stop moments for this function are defined under setting [2-26] and [2-27].	1	 ● ● ● ● ● ● ● ●	Level 1
	2	 ● ● ● ● ● ● ● ●	Level 2
	3	 ● ● ● ● ● ● ● ●	Level 3
			Level 3<Level 2<Level 1
[2-25]  ●  ●  ● ● ● ● ● ●	1	 ● ● ● ● ● ● ● ●	Level 1
Low noise operation level via the external control adaptor. If the system needs to be running under low noise operation conditions when an external signal is sent to the unit, this setting defines the level of low noise that will be applied. This setting will only be effective when the optional external control adaptor (DTA104A61/62) is installed and the setting [2-12] was activated.	2 (default)	 ● ● ● ● ● ● ● ● (default)	Level 2
	3	 ● ● ● ● ● ● ● ● (= binary 4)	Level 3
			Level 3<Level 2<Level 1
[2-26]  ●  ●  ●  ● ●	1	 ● ● ● ● ● ● ● ●	20h00
Low noise operation start time. This setting is used in conjunction with setting [2-22].	2 (default)	 ● ● ● ● ● ● ● ● (default)	22h00
	3	 ● ● ● ● ● ● ● ● (= binary 4)	24h00
[2-27]  ●  ●  ●  ● ●	1	 ● ● ● ● ● ● ● ●	6h00
Low noise operation stop time. This setting is used in conjunction with setting [2-22].	2	 ● ● ● ● ● ● ● ●	7h00
	3 (default)	 ● ● ● ● ● ● ● ● (= binary 4) (default)	8h00

Setting	Value		
	 (8 HP)	H1P H2P H3P H4P H5P H6P H7P (5 HP)	Description
[2-30]  Power consumption limitation level (step 1) via the external control adaptor (DTA104A61/62). If the system needs to be running under power consumption limitation conditions when an external signal is sent to the unit, this setting defines the level power consumption limitation that will be applied for step 1. The level is according to the table.	1		60%
	2	—	65%
	3 (default)	 (= binary 2) (default)	70%
	4	—	75%
	5	 (= binary 4)	80%
	6	—	85%
	7	—	90%
	8	—	95%
[2-31]  Power consumption limitation level (step 2) via the external control adaptor (DTA104A61/62). If the system needs to be running under power consumption limitation conditions when an external signal is sent to the unit, this setting defines the level power consumption limitation that will be applied for step 2. The level is according to the table.	—	 (= binary 1)	30%
	1 (default)	 (= binary 2) (default)	40%
	2	 (= binary 4)	50%
	3	—	55%
[2-32]  Forced, all time, power consumption limitation operation (no external control adaptor is required to perform power consumption limitation). If the system always needs to be running under power consumption limitation conditions, this setting activates and defines the level power consumption limitation that will be applied continuously. The level is according to the table.	0 (default)	 (= binary 1) (default)	Function not active.
	1	 (= binary 2)	Follows [2-30] setting.
	2	 (= binary 4)	Follows [2-31] setting.
[2-81] (in case of 8 HP)  (= binary [2-41]) (in case of 5 HP) Cooling comfort setting. This setting is used in conjunction with setting [2-8].	0		Eco
	1 (default)	 (default)	Mild
	2		Quick
	3		Powerful
[2-82] (in case of 8 HP)  (= binary [2-42]) (in case of 5 HP) Heating comfort setting. This setting is used in conjunction with setting [2-9].	0		Eco
	1 (default)	 (default)	Mild
	2		Quick
	3		Powerful

7 Configuration

7.2.9 To connect the PC configurator to the compressor unit

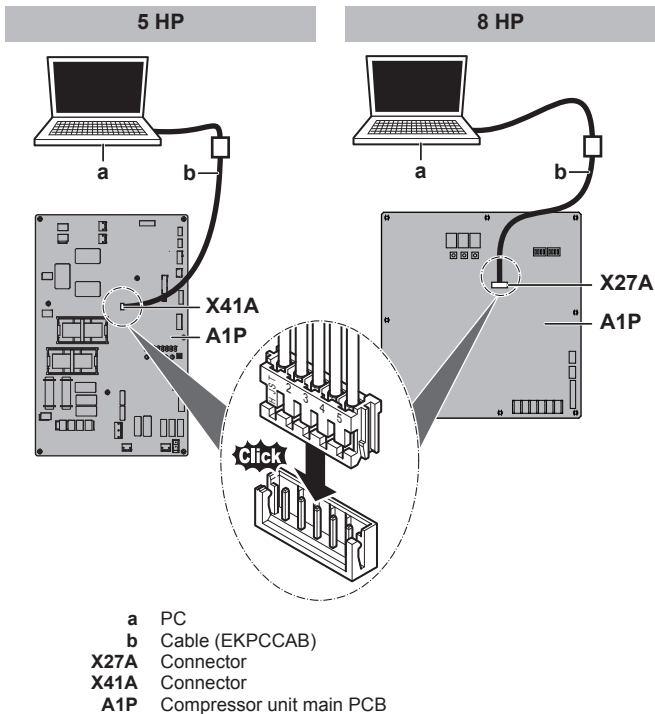

7.3 Energy saving and optimum operation

This heat pump system is equipped with advanced energy saving functionality. Depending on the priority, emphasises can be put on energy saving or comfort level. Several parameters can be selected, resulting in the optimal balance between energy consumption and comfort for the particular application.

Several patterns are available and explained below. Modify the parameters to the needs of your building and to realize the best balance between energy consumption and comfort.

No matter which control is selected, variations on the behaviour of the system are still possible due to protection controls to keep the unit operating under reliable conditions. The intentional target, however, is fixed and will be used to obtain the best balance between energy consumption and comfort, depending on the application type.

7.3.1 Available main operation methods

Basic

The refrigerant temperature is fixed independent from the situation. It corresponds to the standard operation which is known and can be expected from/under previous VRV systems.

To activate this in...	Change...
Cooling operation	[2-8]=2
Heating operation	[2-9]=6

Automatic

The refrigerant temperature is set depending on the outdoor ambient conditions. As such adjusting the refrigerant temperature to match the required load (which is also related to the outdoor ambient conditions).

E.g., when your system is operating in cooling, you do not need as much cooling under low outdoor ambient temperatures (e.g., 25°C) as under high outdoor ambient temperatures (e.g., 35°C). Using this

idea, the system automatically starts increasing its refrigerant temperature, automatically reducing the delivered capacity and increasing the system's efficiency.

E.g., when your system is operating in heating, you do not need as much heating under high outdoor ambient temperatures (e.g., 15°C) as under low outdoor ambient temperatures (e.g., -5°C). Using this idea, the system automatically starts decreasing its refrigerant temperature, automatically reducing the delivered capacity and increasing the system's efficiency.

To activate this in...	Change...
Cooling operation	[2-8]=0 (default)
Heating operation	[2-9]=0 (default)

Hi-sensible/economic (cooling/heating)

The refrigerant temperature is set higher/lower (cooling/heating) compared to basic operation. The focus under high sensible mode is comfort feeling for the customer.

The selection method of indoor units is important and has to be considered as the available capacity is not the same as under basic operation.

For details concerning to Hi-sensible applications, please contact your dealer.

To activate this in...	Change...
Cooling operation	[2-8] to the appropriate value, matching the requirements of the pre-designed system containing a high sensible solution.
Heating operation	[2-9] to the appropriate value, matching the requirements of the pre-designed system containing a high sensible solution.

[2-8]	T _e target (°C)
2	6
3	7
4	8
5	9
6	10
7	11

[2-9]	T _c target (°C)
1	41
3	43
6	46

7.3.2 Available comfort settings

For each of above modes a comfort level can be selected. The comfort level is related to the timing and the effort (energy consumption) which is put in achieving a certain room temperature by temporarily changing the refrigerant temperature to different values in order to achieve requested conditions more quickly.

Powerful

Overshoot (during heating operation) or undershoot (during cooling operation) is allowed compared to the requested refrigerant temperature, in order to achieve the required room temperature very fast. The overshoot is allowed from the start up moment.

- In case of cooling operation the evaporating temperature is allowed to go down to 3°C on temporary base depending on the situation.
- In case of heating operation the condense temperature is allowed to go up to 49°C on temporary base depending on the situation.

- When the request from the indoor units becomes more moderate, the system will eventually go to the steady state condition which is defined by the operation method above.

To activate this in...	Change...
Cooling operation	[2-81]=3 (in case of 8 HP) [2-41]=3 (in case of 5 HP). This setting is used in conjunction with setting [2-8].
Heating operation	[2-82]=3 (in case of 8 HP) [2-42]=3 (in case of 5 HP). This setting is used in conjunction with setting [2-9]

Quick

Overshoot (during heating operation) or undershoot (during cooling operation) is allowed compared to the requested refrigerant temperature, in order to achieve the required room temperature very fast. The overshoot is allowed from the start up moment.

- In case of cooling operation the evaporating temperature is allowed to go down to 6°C on temporary base depending on the situation.
- In case of heating operation the condense temperature is allowed to go up to 46°C on temporary base depending on the situation.
- When the request from the indoor units becomes more moderate, the system will eventually go to the steady state condition which is defined by the operation method above.

To activate this in...	Change...
Cooling operation	[2-81]=2 (in case of 8 HP) [2-41]=2 (in case of 5 HP). This setting is used in conjunction with setting [2-8].
Heating operation	[2-82]=2 (in case of 8 HP) [2-42]=2 (in case of 5 HP). This setting is used in conjunction with setting [2-9].

Mild

Overshoot (during heating operation) or undershoot (during cooling operation) is allowed compared to the requested refrigerant temperature, in order to achieve the required room temperature very fast. The overshoot is not allowed from the start up moment. The start up occurs under the condition which is defined by the operation mode above.

- In case of cooling operation the evaporating temperature is allowed to go down to 6°C on temporary base depending on the situation.
- In case of heating operation the condense temperature is allowed to go up to 46°C on temporary base depending on the situation.
- When the request from the indoor units becomes more moderate, the system will eventually go to the steady state condition which is defined by the operation method above.
- The start up condition is different from the powerful and quick comfort setting.

To activate this in...	Change...
Cooling operation	[2-81]=1 (in case of 8 HP) [2-41]=1 (in case of 5 HP). This setting is used in conjunction with setting [2-8].

To activate this in...	Change...
Heating operation	[2-82]=1 (in case of 8 HP) [2-42]=1 (in case of 5 HP). This setting is used in conjunction with setting [2-9].

Eco

The original refrigerant temperature target, which is defined by the operation method (see above) is kept without any correction, unless for protection control.

To activate this in...	Change...
Cooling operation	[2-81]=0 (in case of 8 HP) [2-41]=0 (in case of 5 HP). This setting is used in conjunction with setting [2-8].
Heating operation	[2-82]=0 (in case of 8 HP) [2-42]=0 (in case of 5 HP). This setting is used in conjunction with setting [2-9].

7.3.3 Example: Automatic mode during cooling

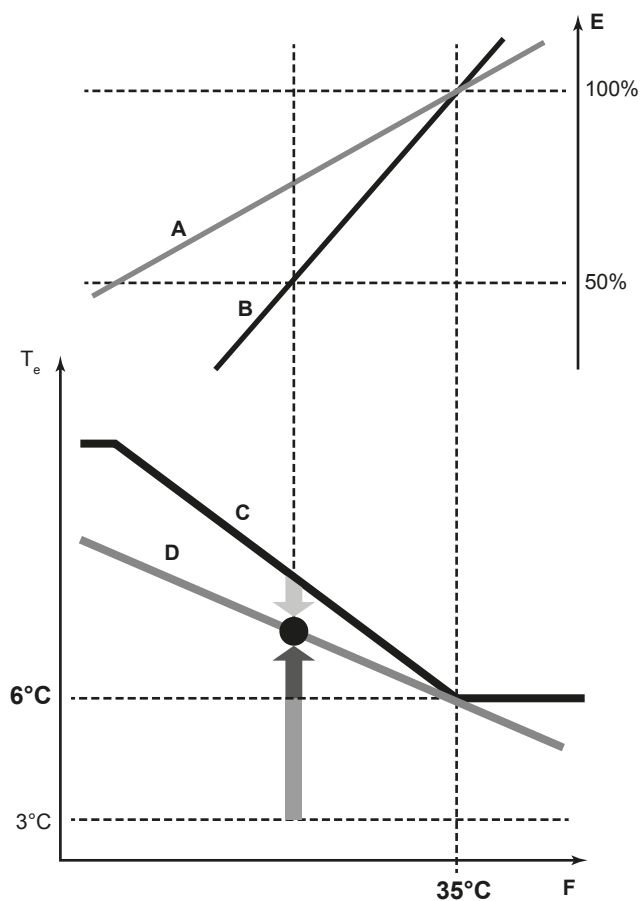

- A Actual load curve
- B Virtual load curve (initial capacity automatic mode)
- C Virtual target value (initial evaporation temperature value automatic mode)
- D Required evaporation temperature value
- E Load factor
- F Outside air temperature
- T_e Evaporating temperature
- Quick
- Powerful
- Mild

8 Commissioning

Room temperature evolution:

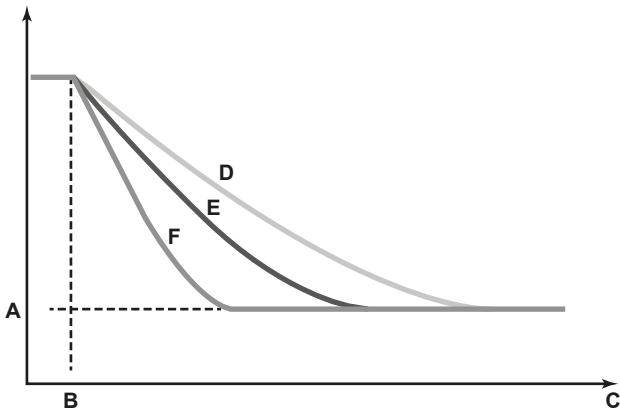

A Indoor unit set temperature
 B Operation start
 C Operating time
 D Mild
 E Quick
 F Powerful

Room temperature evolution:

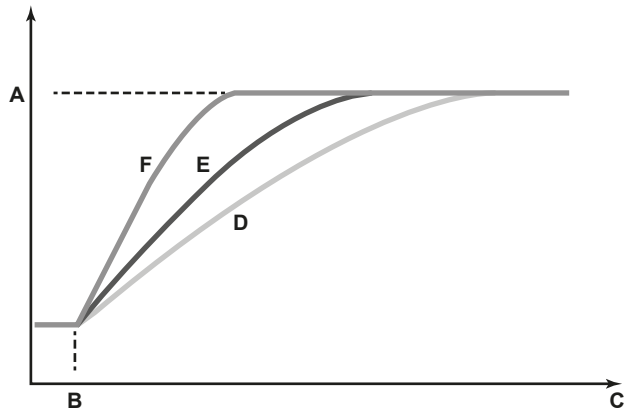

A Indoor unit set temperature
 B Operation start
 C Operating time
 D Mild
 E Quick
 F Powerful

7.3.4 Example: Automatic mode during heating

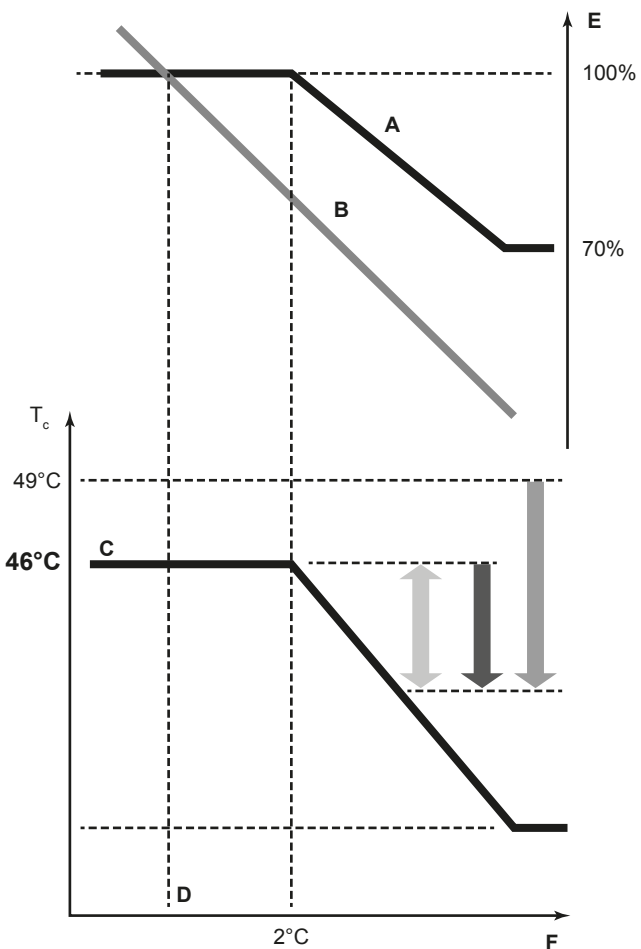

A Virtual load curve (default automatic mode peak capacity)
 B Load curve
 C Virtual target value (initial condensation temperature value automatic mode)
 D Design temperature
 E Load factor
 F Outside air temperature
 T_c Condensing temperature
 Quick
 Powerful
 Mild

8 Commissioning

8.1 Overview: Commissioning

After installation and once the field settings are defined, the installer is obliged to verify correct operation. Therefore a test run must be performed according to the procedures described below.

This chapter describes what you have to do and know to commission the system after it is configured.

Commissioning typically consists of the following stages:

- 1 Checking the "Checklist before commissioning".
- 2 Performing a test run.
- 3 If necessary, correcting errors after abnormal completion of the test run.
- 4 Operating the system.

8.2 Precautions when commissioning



DANGER: RISK OF ELECTROCUTION



DANGER: RISK OF BURNING



CAUTION

Do not perform the test operation while working on the indoor units or the heat exchanger unit.

When performing the test operation, not only the compressor unit will operate, but the heat exchanger unit and the connected indoor units as well. Working on an indoor unit or the heat exchanger unit while performing a test operation is dangerous.



CAUTION

Do not insert fingers, rods or other objects into the air inlet or outlet. Do not remove the fan guard. When the fan is rotating at high speed, it will cause injury.



INFORMATION

During the first running period of the unit, the required power may be higher than stated on the nameplate of the unit. This phenomenon is caused by the compressor, that needs a continuous run time of 50 hours before reaching smooth operation and stable power consumption.

**NOTICE**

Be sure to turn on the power 6 hours before operation in order to have power running to the crankcase heater and to protect the compressor.

During test operation, the compressor unit, the heat exchanger unit and the indoor units will start up. Make sure that the preparations of the heat exchanger unit and all the indoor units are finished (field piping, electrical wiring, air purge, ...). See installation manual of the indoor units for details.

8.3 Checklist before commissioning

After the installation of the unit, first check the following items. Once all below checks are fulfilled, the unit must be closed, only then can the unit be powered up.

<input type="checkbox"/>	You read the complete installation and operation instructions, as described in the installer and user reference guide .
<input type="checkbox"/>	Installation Check that the unit is properly installed, to avoid abnormal noises and vibrations when starting up the unit.
<input type="checkbox"/>	Field wiring Be sure that the field wiring has been carried out according to the instructions described in the chapter "6.9 Connecting the electrical wiring" on page 28, according to the wiring diagrams and according to the applicable legislation.
<input type="checkbox"/>	Power supply voltage Check the power supply voltage on the local supply panel. The voltage must correspond to the voltage on the identification label of the unit.
<input type="checkbox"/>	Earth wiring Be sure that the earth wires have been connected properly and that the earth terminals are tightened.
<input type="checkbox"/>	Insulation test of the main power circuit Using a megatester for 500 V, check that the insulation resistance of 2 MΩ or more is attained by applying a voltage of 500 V DC between power terminals and earth. Never use the megatester for the transmission wiring.
<input type="checkbox"/>	Fuses, circuit breakers, or protection devices Check that the fuses, circuit breakers, or the locally installed protection devices are of the size and type specified in the chapter "5.4.2 Safety device requirements" on page 16. Be sure that neither a fuse nor a protection device has been bypassed.
<input type="checkbox"/>	Internal wiring Visually check the electrical component box and the inside of the unit on loose connections or damaged electrical components.
<input type="checkbox"/>	Pipe size and pipe insulation Be sure that correct pipe sizes are installed and that the insulation work is properly executed.
<input type="checkbox"/>	Stop valves Be sure that the stop valves are open on both liquid and gas side.
<input type="checkbox"/>	Damaged equipment Check the inside of the unit on damaged components or squeezed pipes.

<input type="checkbox"/>	Refrigerant leak Check the inside of the unit on refrigerant leakage. If there is a refrigerant leak, try to repair the leak. If the repair is unsuccessful, call your local dealer. Do not touch any refrigerant which has leaked out from refrigerant piping connections. This may result in frostbite.
<input type="checkbox"/>	Oil leak Check the compressor for oil leakage. If there is an oil leak, try to repair the leak. If the repairing is unsuccessful, call your local dealer.
<input type="checkbox"/>	Air inlet/outlet Check that the air inlet and outlet of the unit is not obstructed by paper sheets, cardboard, or any other material.
<input type="checkbox"/>	Additional refrigerant charge The amount of refrigerant to be added to the unit shall be written on the included "Added refrigerant" plate and attached to the rear side of the front cover.
<input type="checkbox"/>	Installation date and field setting Be sure to keep record of the installation date on the sticker on the rear of the front panel according to EN60335-2-40 and keep record of the contents of the field setting(s).
<input type="checkbox"/>	Insulation and air leaks Make sure the unit is fully insulated and checked for air leaks. Possible consequence: Condensate water might drip.
<input type="checkbox"/>	Drainage Make sure drainage flows smoothly. Possible consequence: Condensate water might drip.
<input type="checkbox"/>	External static pressure Make sure the external static pressure is set. Possible consequence: Insufficient cooling or heating.

8.4 Checklist during commissioning

<input type="checkbox"/>	To perform a test run .
--------------------------	--------------------------------

8.4.1 About test run

The procedure below describes the test operation of the complete system. This operation checks and judges following items:

- Check of wrong wiring (communication check with indoor units and heat exchanger unit).
- Check of the stop valves opening.
- Check of wrong piping. **Example:** Gas or liquid pipes switched.
- Judgement of piping length.

Make sure to carry out the system test operation after the first installation. Otherwise, the malfunction code **U3** will be displayed on the user interface and normal operation or individual indoor unit test run cannot be carried out.

Abnormalities on indoor units cannot be checked for each unit separately. After the test operation is finished, check the indoor units one by one by performing a normal operation using the user interface. Refer to the indoor unit installation manual for more details concerning the individual test run.

8 Commissioning

INFORMATION

- It may take 10 minutes to achieve a uniform refrigerant state before the compressor starts.
- During the test operation, the refrigerant running sound or the magnetic sound of a solenoid valve may become loud and the display indication may change. These are not malfunctions.

8.4.2 To perform a test run (7-LEDs display)

(in case of 5 HP)

- Make sure all field settings you want are set; see "7.2 Making field settings" on page 32.
- Turn ON the power to the compressor unit, heat exchanger unit, and the connected indoor units.









NOTICE

Be sure to turn on the power 6 hours before operation in order to have power running to the crankcase heater and to protect the compressor.

- Make sure the default (idle) situation is existing (H1P is OFF); see "7.2.4 To access mode 1 or 2" on page 34. Push BS4 for 5 seconds or more. The unit will start test operation.

Result: The test operation is automatically carried out, the compressor unit H2P flashes and the indication "Test operation" and "Under centralised control" will display on the user interface of indoor units.



Steps during the automatic system test run procedure:

Step	Description
	Control before start up (pressure equalisation)
	Cooling start up control
	Cooling stable condition
	Communication check
	Stop valve check
	Pipe length check
	Pump down operation
	Unit stop

INFORMATION

During the test operation, it is not possible to stop the unit operation from a user interface. To abort the operation, press BS3. The unit will stop after ±30 seconds.

- Check the test operation results on the compressor unit 7-LEDs display.

Completion	Description
Normal completion	
Abnormal completion	 Refer to "8.4.4 Correcting after abnormal completion of the test run" on page 44 to take actions for correcting the abnormality. When the test operation is fully completed, normal operation will be possible after 5 minutes.

8.4.3 To perform a test run (7-segments display)

(in case of 8 HP)

- Make sure all field settings you want are set; see "7.2 Making field settings" on page 32.

- Turn ON the power to the compressor unit, heat exchanger unit, and the connected indoor units.

NOTICE

Be sure to turn on the power 6 hours before operation in order to have power running to the crankcase heater and to protect the compressor.

- Make sure the default (idle) situation is existing; see "7.2.4 To access mode 1 or 2" on page 34. Push BS2 for 5 seconds or more. The unit will start test operation.

Result: The test operation is automatically carried out, the compressor unit display will indicate "E0" and the indication "Test operation" and "Under centralised control" will display on the user interface of indoor units.

Steps during the automatic system test run procedure:

Step	Description
E01	Control before start up (pressure equalisation)
E02	Cooling start up control
E03	Cooling stable condition
E04	Communication check
E05	Stop valve check
E06	Pipe length check
E09	Pump down operation
E10	Unit stop

INFORMATION

During the test operation, it is not possible to stop the unit operation from a user interface. To abort the operation, press BS3. The unit will stop after ±30 seconds.

- Check the test operation results on the compressor unit 7-segment display.

Completion	Description
Normal completion	No indication on the 7-segment display (idle).
Abnormal completion	Indication of malfunction code on the 7-segment display. Refer to "8.4.4 Correcting after abnormal completion of the test run" on page 44 to take actions for correcting the abnormality. When the test operation is fully completed, normal operation will be possible after 5 minutes.

8.4.4 Correcting after abnormal completion of the test run

The test operation is only completed if there is no malfunction code displayed. In case of a displayed malfunction code, perform correcting actions as explained in the malfunction code table. Carry out the test operation again and confirm that the abnormality is properly corrected.

INFORMATION

If a malfunction occurs:

- In case of 5 HP: The error code is displayed on the user interface of the indoor unit.
- In case of 8 HP: The error code is displayed on the compressor unit's 7-segments display and on the user interface of the indoor unit.

INFORMATION

Refer to the installation manual of the indoor unit for detailed malfunction codes related to indoor units.

8.4.5 Operating the unit

Once the units are installed and test operation of compressor unit, heat exchanger unit and indoor units is finished, the operation of the system can start.

For operating the indoor unit, the user interface of the indoor unit should be switched ON. Refer to the indoor unit operation manual for more details.

9 Hand-over to the user

Once the test run is finished and the unit operates properly, please make sure the following is clear for the user:

- Make sure that the user has the printed documentation and ask him/her to keep it for future reference. Inform the user that he can find the complete documentation on the url as earlier described in this manual.
- Explain the user how to properly operate the system and what to do in case of problems.
- Show the user what to do in relation to maintaining the unit.

10 Maintenance and service



NOTICE

Maintenance must be done by an authorised installer or service agent.

We recommend to do maintenance at least once a year. However, applicable legislation might require shorter maintenance intervals.



NOTICE

In Europe, the **greenhouse gas emissions** of the total refrigerant charge in the system (expressed as tonnes CO₂-equivalent) is used to determine the maintenance intervals. Follow the applicable legislation.

Formula to calculate the greenhouse gas emissions:
GWP value of the refrigerant × Total refrigerant charge [in kg] / 1000

10.1 Overview: Maintenance and service

This chapter contains information about:

- Preventing electrical hazards when maintaining and servicing the system
- The refrigerant recovery operation

10.2 Maintenance safety precautions

DANGER: RISK OF ELECTROCUTION

DANGER: RISK OF BURNING

NOTICE: Risk of electrostatic discharge
Before performing any maintenance or service work, touch a metal part of the unit in order to eliminate static electricity and to protect the PCB.

10.2.1 To prevent electrical hazards

When performing service to inverter equipment:

- 1 Do not open the electrical component box cover for 10 minutes after the power supply is turned off.
- 2 Measure the voltage between terminals on the terminal block for power supply with a tester and confirm that the power supply is shut off. In addition, measure points as shown in the figure below, with a tester and confirm that the voltage of the capacitor in the main circuit is less than 50 V DC.

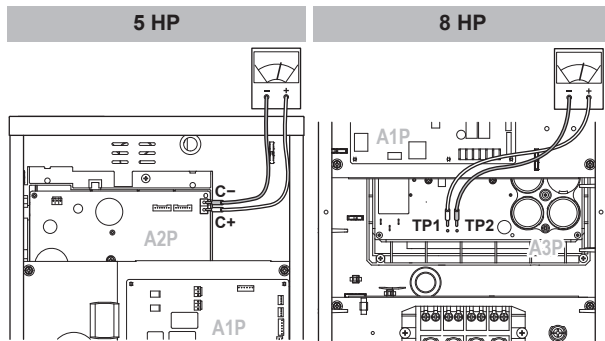

- 3 To prevent damaging the PCB, touch a non-coated metal part to eliminate static electricity before pulling out or plugging in connectors.

For details refer to the wiring diagram labelled on the back of the service cover.

10.3 Checklist for yearly maintenance of the heat exchanger unit

Check the following at least once a year:

- Heat exchanger.

The heat exchanger can get blocked up due to dust, dirt, leaves, etc. It is recommended to clean the heat exchanger yearly. A blocked heat exchanger can lead to too low pressure or too high pressure leading to worse performance.

10.4 About service mode operation

Refrigerant recovery operation/vacuuming operation is possible by applying setting [2-21]. Refer to "7.2 Making field settings" on page 32 for details how to set mode 2.

When vacuuming/recovery mode is used, check very carefully what should be vacuumed/recovered before starting. See installation manual of the indoor unit for more information about vacuuming and recovery.

10.4.1 To use vacuum mode

- 1 When the unit is at standstill, activate setting [2-21] to start vacuuming mode.

Model	Result
5 HP	When confirmed, the expansion valves (in the indoor unit, compressor unit and heat exchanger unit) will fully open. At that moment H1P lights and the user interface of all indoor units indicate TEST (test operation) and (external control) and the operation will be prohibited.
8 HP	When confirmed, the expansion valves (in the indoor unit, compressor unit and heat exchanger unit) will fully open. At that moment the 7-segment display indication= and the user interface of all indoor units indicate TEST (test operation) and (external control) and the operation will be prohibited.

- 2 Evacuate the system with a vacuum pump.

11 Troubleshooting

- Press BS1 (in case of 5 HP) or BS3 (in case of 8 HP) to stop vacuuming mode.

10.4.2 To recover refrigerant

This should be done by a refrigerant reclaimer. Follow the same procedure as for vacuuming method.



DANGER: RISK OF EXPLOSION

Pump down – Refrigerant leakage. If you want to pump down the system, and there is a leakage in the refrigerant circuit:

- Do NOT use the unit's automatic pump down function, with which you can collect all refrigerant from the system into the outdoor unit. **Possible consequence:** Self-combustion and explosion of the compressor because of air going into the operating compressor.
- Use a separate recovery system so that the unit's compressor does NOT have to operate.



NOTICE

Make sure to NOT recover any oil while recovering refrigerant. **Example:** By using an oil separator.

11 Troubleshooting

11.1 Overview: Troubleshooting

Before troubleshooting

Carry out a thorough visual inspection of the unit and look for obvious defects such as loose connections or defective wiring.

11.2 Precautions when troubleshooting



WARNING

- When carrying out an inspection on the switch box of the unit, always make sure that the unit is disconnected from the mains. Turn off the respective circuit breaker.
- When a safety device was activated, stop the unit and find out why the safety device was activated before resetting it. NEVER bridge safety devices or change their values to a value other than the factory default setting. If you are unable to find the cause of the problem, call your dealer.

11.3.1 Error codes: Overview

In case of 5 HP:

Main code	Cause	Solution
E0	<ul style="list-style-type: none"> Heat exchanger fan malfunction. Drain pump feedback contact is open. 	In the heat exchanger unit: <ul style="list-style-type: none"> Check connection on PCB: A1P (X15A) Check connection on terminal block (X2M) Check the fan connectors.
E3	<ul style="list-style-type: none"> The stop valves of the compressor unit are left closed. Refrigerant overcharge 	<ul style="list-style-type: none"> Open the stop valves on both the gas and liquid side. Recalculate the required amount of refrigerant from the piping length and correct the refrigerant charge level by recovering any excessive refrigerant with a refrigerant recovery machine.



DANGER: RISK OF ELECTROCUTION



WARNING

Prevent hazard due to the inadvertent resetting of the thermal cut-out: this appliance must NOT be supplied through an external switching device, such as a timer, or connected to a circuit that is regularly turned ON and OFF by the utility.



DANGER: RISK OF BURNING

11.3 Solving problems based on error codes

In case of a displayed malfunction code, perform correcting actions as explained in the malfunction code table.

After correcting the abnormality, press BS3 to reset the malfunction code and retry operation.



INFORMATION

If a malfunction occurs:

- In case of 5 HP: The error code is displayed on the user interface of the indoor unit.
- In case of 8 HP: The error code is displayed on the compressor unit's 7-segments display and on the user interface of the indoor unit.

In case of 8 HP: The error code on the compressor unit will indicate a main malfunction code and a sub code. The sub code indicates more detailed information about the malfunction code. The main code and sub code will be displayed intermittently (with an interval of 1 second). **Example:**

- Main code: E3
- Sub code: -01

11 Troubleshooting

Main code	Cause	Solution
E4	<ul style="list-style-type: none"> The stop valves of the compressor unit are left closed. Insufficient refrigerant 	<ul style="list-style-type: none"> Open the stop valves on both the gas and liquid side. Check if the additional refrigerant charge has been finished correctly. Recalculate the required amount of refrigerant from the piping length and add an adequate amount of refrigerant.
E9	Electronic expansion valve malfunction Heat exchanger unit: (Y1E) - A1P (X7A) Compressor unit: (Y1E) - A1P (X22A)	Check connection on PCB or actuator.
F3	<ul style="list-style-type: none"> The stop valves of the compressor unit are left closed. Insufficient refrigerant 	<ul style="list-style-type: none"> Open the stop valves on both the gas and liquid side. Check if the additional refrigerant charge has been finished correctly. Recalculate the required amount of refrigerant from the piping length and add an adequate amount of refrigerant.
Fb	Refrigerant overcharge	Recalculate the required amount of refrigerant from the piping length and correct the refrigerant charge level by recovering any excessive refrigerant with a refrigerant recovery machine.
H9	Ambient temperature sensor malfunction Heat exchanger unit: (R1T) - A1P (X16A)	Check connection on PCB or actuator.
J3	Discharge temperature sensor malfunction: open circuit / short circuit Compressor unit: (R2T) - A1P (X12A)	Check connection on PCB or actuator.
J4	Heat exchanger gas sensor malfunction Heat exchanger unit: (R2T) - A1P (X18A)	Check connection on PCB or actuator.
J5	Suction temperature sensor malfunction Compressor unit: (R3T) - A1P (X12A) Compressor unit: (R5T) - A1P (X12A)	Check connection on PCB or actuator.
Jb	Coil temperature sensor malfunction Heat exchanger unit: (R3T) - A1P (X17A)	Check connection on PCB or actuator.
J7	Liquid temperature sensor (after subcool HE) malfunction Compressor unit: (R7T) - A1P (X13A)	Check connection on PCB or actuator.
J9	Gas temperature sensor (after subcool HE) malfunction Compressor unit: (R4T) - A1P (X12A)	Check connection on PCB or actuator.
JR	High pressure sensor malfunction: open circuit / short circuit Compressor unit: (BIPH) - A1P (X17A)	Check connection on PCB or actuator.
JL	Low pressure sensor malfunction: open circuit / short circuit Compressor unit: (BIPL) - A1P (X18A)	Check connection on PCB or actuator.
LL	Transmission compressor unit - inverter: INV1 transmission trouble	Check connection.
P1	INV1 unbalanced power supply voltage	Check if power supply is within range.
PJ	Heat exchanger unit capacity setting malfunction.	Check the type of heat exchanger unit. If necessary, replace the heat exchanger unit.
U2	Insufficient supply voltage	Check if the supply voltage is supplied properly.
U3	Malfunction code: System test run not yet executed (system operation not possible)	Execute system test run.
U4	<ul style="list-style-type: none"> No power is supplied to the compressor unit. Transmission wiring malfunction 	<ul style="list-style-type: none"> Check if all units are powered on. Check the transmission wiring.
U9	<ul style="list-style-type: none"> System mismatch. Wrong type of indoor units combined (R410A, R407C, RA, etc). Indoor unit malfunction Heat exchanger unit malfunction 	<ul style="list-style-type: none"> Check if other indoor units have malfunction and confirm indoor unit mix is allowed. Check the transmission wiring to the heat exchanger unit.
UR	<ul style="list-style-type: none"> Improper type of indoor units are connected. Mismatch of compressor unit and heat exchanger unit. 	<ul style="list-style-type: none"> Check the type of indoor units that are currently connected. If they are not proper, replace them with proper ones. Check if the compressor unit and heat exchanger unit are compatible.

11 Troubleshooting

Main code	Cause	Solution
<i>UF</i>	<ul style="list-style-type: none"> The stop valves of the compressor unit are left closed. The piping and wiring of the specified indoor unit or heat exchanger unit are not connected correctly to the compressor unit. 	<ul style="list-style-type: none"> Open the stop valves on both the gas and liquid side. Confirm that the piping and wiring of the specified indoor unit or heat exchanger unit are connected correctly to the compressor unit.

In case of 8 HP:

Main code	Sub code	Cause	Solution
<i>E0</i>	<i>-02</i>	<ul style="list-style-type: none"> Heat exchanger fan malfunction. Drain pump feedback contact is open. 	In the heat exchanger unit: <ul style="list-style-type: none"> Check connection on PCB: A1P (X15A) Check connection on terminal block (X2M) Check the fan connectors.
<i>E2</i>	<i>-01</i>	Earth leakage detector activated Compressor unit: (T1A) - A1P (X101A)	Restart the unit. If the problem reoccurs, contact your dealer.
	<i>-0b</i>	No earth leakage detector detected Compressor unit: (T1A) - A1P (X101A)	Replace the earth leakage detector.
<i>E3</i>	<i>-01</i>	High pressure switch was activated Compressor unit: (S1PH) - A1P (X4A)	Check stop valve situation or abnormalities in (field) piping or airflow over air cooled coil.
	<i>-02</i>	<ul style="list-style-type: none"> Refrigerant overcharge Stop valve closed 	<ul style="list-style-type: none"> Check refrigerant amount+recharge unit. Open stop valves
	<i>-13</i>	Stop valve closed (liquid)	Open liquid stop valve.
	<i>-18</i>	<ul style="list-style-type: none"> Refrigerant overcharge Stop valve closed 	<ul style="list-style-type: none"> Check refrigerant amount+recharge unit. Open stop valves.
<i>E4</i>	<i>-01</i>	Low pressure malfunction: <ul style="list-style-type: none"> Stop valve closed Refrigerant shortage Indoor unit malfunction 	<ul style="list-style-type: none"> Open stop valves. Check refrigerant amount+recharge unit. Check the user interface's display or transmission wiring between the outdoor unit and the indoor unit.
<i>E9</i>	<i>-01</i>	Electronic expansion valve malfunction (subcool) Compressor unit: (Y1E) - A1P (X21A)	Check connection on PCB or actuator.
	<i>-47</i>	Electronic expansion valve malfunction (main) Heat exchanger unit: (Y1E) - A1P (X7A)	Check connection on PCB or actuator.
<i>F3</i>	<i>-01</i>	Discharge temperature too high: <ul style="list-style-type: none"> Stop valve closed Refrigerant shortage Compressor unit: (R21T) - A1P (X29A)	<ul style="list-style-type: none"> Open stop valves. Check refrigerant amount+recharge unit.
<i>Fb</i>	<i>-02</i>	<ul style="list-style-type: none"> Refrigerant overcharge Stop valve closed 	<ul style="list-style-type: none"> Check refrigerant amount+recharge unit. Open stop valves.
<i>H9</i>	<i>-01</i>	Ambient temperature sensor malfunction Heat exchanger unit: (R1T) - A1P (X16A)	Check connection on PCB or actuator.
<i>J3</i>	<i>-1b</i>	Discharge temperature sensor malfunction Compressor unit: (R21T): open circuit - A1P (X29A)	Check connection on PCB or actuator.
	<i>-17</i>	Discharge temperature sensor malfunction Compressor unit: (R21T): short circuit - A1P (X29A)	Check connection on PCB or actuator.
<i>J4</i>	<i>-01</i>	Heat exchanger gas sensor malfunction Heat exchanger unit: (R2T) - A1P (X18A)	Check connection on PCB or actuator.
<i>J5</i>	<i>-01</i>	Suction temperature sensor malfunction Compressor unit: (R3T) - A1P (X30A)	Check connection on PCB or actuator.
	<i>-02</i>	Suction temperature sensor malfunction Compressor unit: (R7T) - A1P (X30A)	Check connection on PCB or actuator.
<i>Jb</i>	<i>-01</i>	De-icing temperature sensor malfunction Heat exchanger unit: (R3T) - A1P (X17A)	Check connection on PCB or actuator

11 Troubleshooting

Main code	Sub code	Cause	Solution
J7	-0b	Liquid temperature sensor (after subcool HE) malfunction Compressor unit: (R5T) - A1P (X30A)	Check connection on PCB or actuator.
J9	-01	Gas temperature sensor (after subcool HE) malfunction Compressor unit: (R6T) - A1P (X30A)	Check connection on PCB or actuator.
JA	-0b	High pressure sensor malfunction Compressor unit: (S1NPH): open circuit - A1P (X32A)	Check connection on PCB or actuator.
	-07	High pressure sensor malfunction Compressor unit: (S1NPH): short circuit - A1P (X32A)	Check connection on PCB or actuator.
JC	-0b	Low pressure sensor malfunction Compressor unit: (S1NPL): open circuit - A1P (X31A)	Check connection on PCB or actuator.
	-07	Low pressure sensor malfunction Compressor unit: (S1NPL): short circuit - A1P (X31A)	Check connection on PCB or actuator.
LC	-14	Transmission outdoor unit - inverter: INV1 transmission trouble Compressor unit: A1P (X20A, X28A, X42A)	Check connection.
PI	-01	INV1 unbalanced power supply voltage	Check if power supply is within range.
PJ	-01	Heat exchanger unit capacity setting malfunction.	Check the type of heat exchanger unit. If necessary, replace the heat exchanger unit.
U1	-01	Reversed power supply phase malfunction	Correct phase order.
	-04	Reversed power supply phase malfunction	Correct phase order.
U2	-01	INV1 voltage power shortage	Check if power supply is within range.
	-02	INV1 power phase loss	Check if power supply is within range.
U3	-03	Malfunction code: System test run not yet executed (system operation not possible)	Execute system test run.
U4	-01	Faulty wiring to Q1/Q2 or indoor - outdoor	Check (Q1/Q2) wiring. Do NOT use Q1/Q2.
	-03	Faulty wiring to Q1/Q2 or indoor - outdoor	Check (Q1/Q2) wiring. Do NOT use Q1/Q2.
	-04	System test run abnormal ending	Execute test run again.
U7	-01	Warning: faulty wiring to Q1/Q2	Check Q1/Q2 wiring. Do NOT use Q1/Q2.
	-02	Malfunction code: faulty wiring to Q1/Q2	Check Q1/Q2 wiring. Do NOT use Q1/Q2.
	-11	<ul style="list-style-type: none"> Too many indoor units are connected to F1/F2 line Bad wiring between outdoor and indoor units 	Check indoor unit amount and total capacity connected.
U9	-01	<ul style="list-style-type: none"> System mismatch. Wrong type of indoor units combined (R410A, R407C, RA, etc). Indoor unit malfunction Heat exchanger unit malfunction 	<ul style="list-style-type: none"> Check if other indoor units have malfunction and confirm indoor unit mix is allowed. Check the transmission wiring to the heat exchanger unit.
UR	-03	More than 1 heat exchanger unit connected.	Check installation. Only 1 heat exchanger unit can be installed.
	-18	<ul style="list-style-type: none"> Improper type of indoor units are connected. Mismatch of compressor unit and heat exchanger unit. 	<ul style="list-style-type: none"> Check the type of indoor units that are currently connected. If they are not proper, replace them with proper ones. Check if the compressor unit and heat exchanger unit are compatible.
	-21	5 HP heat exchanger unit connected.	Check installation. Connect 8 HP heat exchanger unit.
UH	-01	<ul style="list-style-type: none"> Auto address malfunction (inconsistency) Mismatch of compressor unit and heat exchanger unit. 	<ul style="list-style-type: none"> Check if transmission wired unit amount matches with powered unit amount (by monitor mode) or wait till initialisation is finished. Check if the compressor unit and heat exchanger unit are compatible.

12 Disposal

Main code	Sub code	Cause	Solution
UF	-01	<ul style="list-style-type: none"> Auto address malfunction (inconsistency) Mismatch of compressor unit and heat exchanger unit. 	<ul style="list-style-type: none"> Check if transmission wired unit amount matches with powered unit amount (by monitor mode) or wait till initialisation is finished. Check if the compressor unit and heat exchanger unit are compatible.
	-05	<ul style="list-style-type: none"> The stop valves of the compressor unit are left closed. The piping and wiring of the specified indoor unit or heat exchanger unit are not connected correctly to the compressor unit. 	<ul style="list-style-type: none"> Open the stop valves on both the gas and liquid side. Confirm that the piping and wiring of the specified indoor unit or heat exchanger unit are connected correctly to the compressor unit.

12 Disposal

Dismantling of the unit, and treatment of the refrigerant, oil and other parts must comply with the applicable legislation.

13 Technical data

Latest information can be found in the technical engineering data.

13.1 Piping diagram: Compressor unit and heat exchanger unit

5 HP

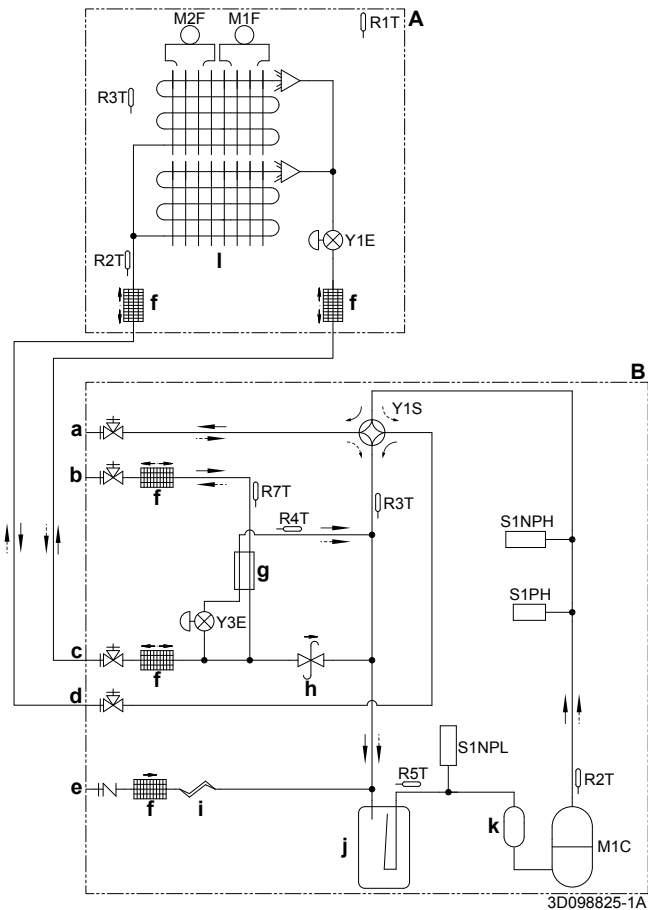



- A** Heat exchanger unit
B Compressor unit
a Stop valve (gas) (circuit 2: to indoor units)
b Stop valve (liquid) (circuit 2: to indoor units)
c Stop valve (liquid) (circuit 1: to heat exchanger unit)
d Stop valve (gas) (circuit 1: to heat exchanger unit)
e Service port (refrigerant charge)
f Filter
g Subcool heat exchanger

- h** Pressure regulating valve
i Capillary tube
j Accumulator
k Compressor accumulator
l Heat exchanger
M1C Compressor
M1F, M2F Fan motor
R1T (A) Thermistor (air)
R2T (A) Thermistor (gas)
R3T (A) Thermistor (coil)
R2T (B) Thermistor (discharge)
R3T (B) Thermistor (suction accumulator)
R4T (B) Thermistor (subcool heat exchanger gas)
R5T (B) Thermistor (suction compressor)
R7T (B) Thermistor (liquid)
S1NPH High pressure sensor
S1NPL Low pressure sensor
S1PH High pressure switch
Y1E, Y3E Electronic expansion valve
Y1S Solenoid valve (4-way valve)
 → Heating
 ⇄ Cooling

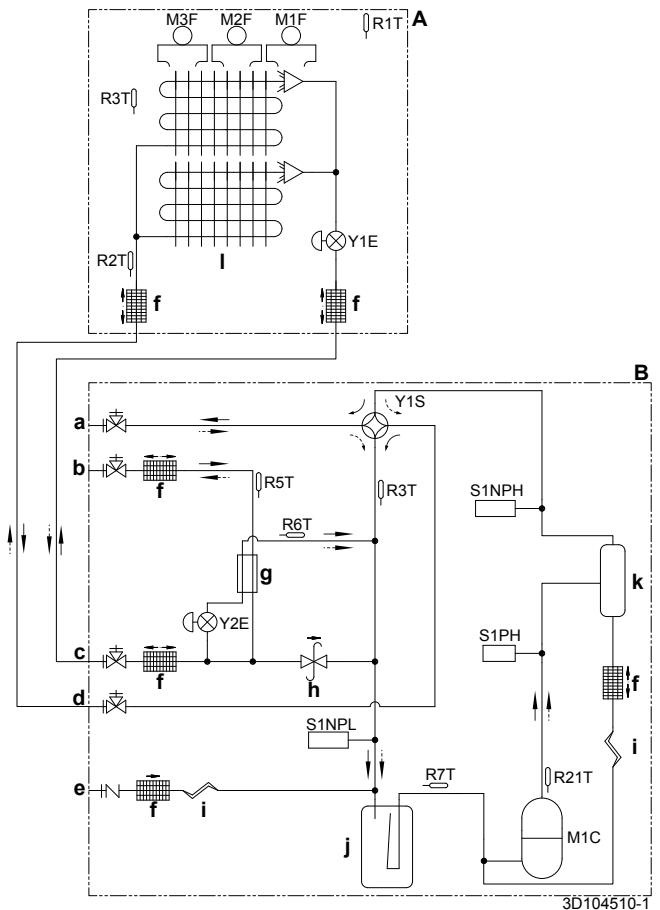
8 HP



- A** Heat exchanger unit
B Compressor unit
a Stop valve (gas) (circuit 2: to indoor units)
b Stop valve (liquid) (circuit 2: to indoor units)
c Stop valve (liquid) (circuit 1: to heat exchanger unit)

d	Stop valve (gas) (circuit 1: to heat exchanger unit)
e	Service port (refrigerant charge)
f	Filter
g	Subcool heat exchanger
h	Pressure regulating valve
i	Capillary tube
j	Accumulator
k	Oil separator
l	Heat exchanger
M1C	Compressor
M1F~M3F	Fan motor
R1T (A)	Thermistor (air)
R2T (A)	Thermistor (gas)
R3T (A)	Thermistor (coil)
R21T (B)	Thermistor (discharge)
R3T (B)	Thermistor (suction accumulator)
R5T (B)	Thermistor (liquid)
R6T (B)	Thermistor (subcool heat exchanger gas)
R7T (B)	Thermistor (suction compressor)
S1NPH	High pressure sensor
S1NPL	Low pressure sensor
S1PH	High pressure switch
Y1E, Y2E	Electronic expansion valve
Y1S	Solenoid valve (4-way valve)
	Heating
	Cooling

R4T	Thermistor (subcool heat exchanger gas)
R5T	Thermistor (suction compressor)
R7T	Thermistor (liquid)
R10T	Thermistor (fin)
S1NPL	Low pressure sensor
S1NPH	High pressure sensor
S1PH	High pressure switch
S*S	Cool/heat selector switch (optional)
V1R	IGBT power module (A2P)
V2R	Diode module (A2P)
X1M	Terminal strip (power supply)
X2M	Terminal strip (transmission wiring)
X*Y	Connector
Y3E	Electronic expansion valve
Y1S	Solenoid valve (4-way valve)
Z*C	Noise filter (ferrite core)
Z*F	Noise filter (A1P)

13.2 Wiring diagram: Compressor unit

The wiring diagram is delivered with the unit, located on the switch box cover.

Symbols:

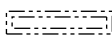
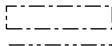
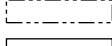
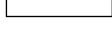
X1M	Main terminal
-----	Earth wiring
<u>15</u>	Wire number 15
-----	Field wire
	Field cable
→ **/12.2	Connection ** continues on page 12 column 2
①	Several wiring possibilities
	Option
	Not mounted in switch box
	Wiring depending on model
	PCB

Legend for wiring diagram 5 HP:

A1P	Printed circuit board (main)
A2P	Printed circuit board (inverter)
BS*	Push button (A1P)
C*	Capacitor (A2P)
DS1	DIP switch (A1P)
F1U, F2U	Fuse (T 31.5 A / 250 V) (A1P)
F3U, F5U	Fuse (T 6.3 A / 250 V) (A1P)
H*P	LED (service monitor orange) (A1P)
HAP	Running LED (service monitor green) (A*P)
K1M	Magnetic contactor (A2P)
K1R	Magnetic relay (A*P)
L1R	Reactor
M1C	Motor (compressor)
M1F	Motor (fan)
PS	Switching power supply (A2P)
Q1DI	Earth leakage circuit breaker (field supply)
R*	Resistor (A2P)
R2T	Thermistor (discharge)
R3T	Thermistor (suction accumulator)

Notes for 8 HP:



- 1 When using the optional adapter, refer to the installation manual of the optional adapter.
- 2 Refer to the installation or service manual on how to use BS1~BS3 push buttons, and DS1+DS2 DIP switches.
- 3 Do not operate the unit by short-circuiting protection device S1PH.
- 4 For connection of INDOOR-OUTDOOR F1-F2 transmission wiring, and OUTDOOR-OUTDOOR F1-F2 transmission wiring, refer to the service manual.

Legend for wiring diagram 8 HP:

A1P	Printed circuit board (main)
A2P	Printed circuit board (noise filter)
A3P	Printed circuit board (inverter)
A4P	Printed circuit board (cool/heat selector)
BS*	Push button (mode, set, return) (A1P)
C*	Capacitor (A3P)
DS*	DIP switch (A1P)
E1HC	Crankcase heater
F*U	Fuse (T 3.15 A / 250 V) (A1P)
F3U	Field fuse
F400U	Fuse (T 6.3 A / 250 V) (A2P)
F410U	Fuse (T 40 A / 500 V) (A2P)
F411U	Fuse (T 40 A / 500 V) (A2P)
F412U	Fuse (T 40 A / 500 V) (A2P)
HAP	Running LED (service monitor green) (A1P)
K1M	Magnetic contactor (A3P)
K*R	Magnetic relay (A*P)
L1R	Reactor
M1C	Motor (compressor)
M1F	Motor (fan)
PS	Power supply (A1P, A3P)
Q1DI	Earth leakage circuit breaker (field supply)
Q1RP	Phase reversal detect circuit (A1P)
R21T	Thermistor (M1C discharge)
R3T	Thermistor (accumulator)
R5T	Thermistor (subcool liquid pipe)

14 About the system

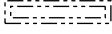
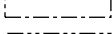
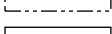
R6T	Thermistor (heat exchanger gas pipe)
R7T	Thermistor (suction)
R*	Resistor (A3P)
S1NPH	High pressure sensor
S1NPL	Low pressure sensor
S1PH	High pressure switch (discharge)
S1S	Air control switch (optional)
S2S	Cool/heat selector switch (optional)
SEG1~SEG3	7-segment display
T1A	Earth leakage detector
V1R	IGBT power module (A3P)
V2R	Diode module (A3P)
X37A	Connector (power supply for option PCB) (optional)
X66A	Connector (cool/heat selector switch) (optional)
X1M	Terminal strip (power supply)
X*A	PCB connector
X*M	Terminal strip on PCB (A*P)
X*Y	Connector
Y2E	Electronic expansion valve
Y1S	Solenoid valve (4-way valve)
Z*C	Noise filter (ferrite core)
Z*F	Noise filter

-----	Field wire
	Field cable
→ **/12.2	Connection ** continues on page 12 column 2
①	Several wiring possibilities
	Option
	Not mounted in switch box
	Wiring depending on model
	PCB

Legend for wiring diagram 5+8 HP:

A1P	Printed circuit board (main)
A2P	Printed circuit board (adapter)
C1	Capacitor (A1P)
E1H	Drain pan heater (optional)
F1U	Fuse (F 1 A / 250 V) (optional)
F1U	Fuse (T 6.3 A / 250 V for PCB) (A1P)
HAP	Running LED (service monitor green) (A1P)
K1a	Auxiliary relay (optional)
M*F	Motor (fan)
Q1DI	Earth leakage circuit breaker (field supply)
PS	Switching power supply (A1P)
R1T	Thermistor (air)
R2T	Thermistor (gas)
R3T	Thermistor (coil)
V1R	Diode module (A1P)
X1M	Terminal strip (power supply)
X2M	Terminal strip (transmission wiring)
X*Y	Connector
Y1E	Electronic expansion valve
Z1C	Noise filter (ferrite core)
Z1F	Noise filter (A1P)

13.3 Wiring diagram: Heat exchanger unit

The wiring diagram is delivered with the unit, located at the inside of the switch box cover.

Symbols:

X1M	Main terminal
-----	Earth wiring
<u>15</u>	Wire number 15

For the user

14 About the system

The VRV IV heat pump for indoor installation can be used for heating/cooling applications.

NOTICE

Do not use the system for other purposes. In order to avoid any quality deterioration, do not use the unit for cooling precision instruments, food, plants, animals or works of art.

NOTICE

For future modifications or expansions of your system:

A full overview of allowable combinations (for future system extensions) is available in technical engineering data and should be consulted. Contact your installer to receive more information and professional advice.

In general following type of indoor units can be connected to a VRV IV heat pump for indoor installation (non-exhaustive list, depending on compressor unit model, heat exchanger unit model and indoor unit model combinations):

- VRV direct expansion (DX) indoor units (air to air applications).

- AHU (air-to-air applications): EKEXV-kit+EKEQM-box required, depending on the application.
- Comfort air curtain (air-to-air applications): CYV (Biddle) series.

Airhandling unit connection in pair to VRV IV heat pump for indoor installation is supported.

Airhandling unit connection in multi to VRV IV heat pump for indoor installation is supported, even combined with VRV direct expansion indoor unit(s).

For more specifications, see technical engineering data.

14.1 System layout

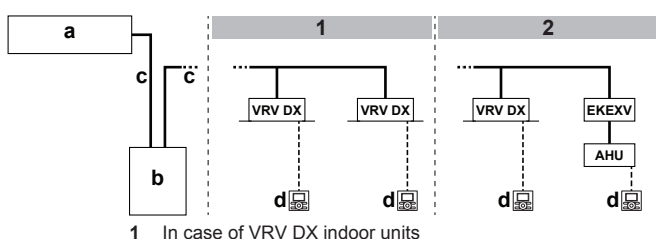

2	In case of VRV DX indoor units combined with an air handling unit
a	Heat exchanger unit
b	Compressor unit
c	Refrigerant piping
d	User interface (dedicated depending on indoor unit type)
VRV DX	VRV direct expansion (DX) indoor unit
EKEXV	Expansion valve kit
AHU	Air handling unit

15 User interface



CAUTION

Never touch the internal parts of the controller.

Do not remove the front panel. Some parts inside are dangerous to touch and appliance problems may happen. For checking and adjusting the internal parts, contact your dealer.

This operation manual will give a non-exhaustive overview of the main functions of the system.

Detailed information on required actions to achieve certain functions can be found in the dedicated installation and operation manual of the indoor unit.

Refer to the operation manual of the installed user interface.

16 Before operation



WARNING

This unit contains electrical and hot parts.



WARNING

Before operating the unit, be sure the installation has been carried out correctly by an installer.



CAUTION

It is not good for your health to expose your body to the air flow for a long time.



CAUTION

To avoid oxygen deficiency, ventilate the room sufficiently if equipment with burner is used together with the system.



CAUTION

Do not operate the system when using a room fumigation-type insecticide. This could cause the chemicals to become deposited in the unit, which could endanger the health of those who are hypersensitive to chemicals.

This operation manual is for the following systems with standard control. Before initiating operation, contact your dealer for the operation that corresponds to your system type and mark. If your installation has a customised control system, ask your dealer for the operation that corresponds to your system.

Operation modes (depending on indoor unit type):

- Heating and cooling (air to air).
- Fan only operation (air to air).

Dedicated functions exist depending on the type of indoor unit, refer to dedicated installation/operation manual for more information.

17 Operation

17.1 Operation range

Use the system in the following temperature and humidity ranges for safe and effective operation.

Specification		5 HP	8 HP
Maximum capacity	Heating	16.0 kW	25.0 kW
	Cooling	14.0 kW	22.4 kW
Outside ambient design temperature	Heating	-20~15.5°C WB	
	Cooling	-5~46°C DB	
Ambient design temperature of compressor unit and heat exchanger unit		5~35°C DB	
Maximum relative humidity around the compressor unit and heat exchanger unit	Heating	50% ^(a)	
	Cooling	80% ^(a)	

- (a) To avoid condensation and water dripping out of the unit. If the temperature or the humidity is beyond these conditions, safety devices may be put in action and the air conditioner may not operate.

Special operation ranges are valid in case of using AHU. They can be found in the installation/operation manual of the dedicated unit. Latest information can be found in the technical engineering data.

17.2 Operating the system

17.2.1 About operating the system

- Operation procedure varies according to the combination of compressor unit, heat exchanger unit, and user interface.
- To protect the unit, turn on the main power switch 6 hours before operation.
- If the main power supply is turned off during operation, operation will restart automatically after the power turns back on again.
- When stopping the unit, the unit might still operate for a few minutes. This is not a malfunction.

17.2.2 About cooling, heating, fan only, and automatic operation

- Changeover cannot be made with a user interface whose display shows "change-over under centralised control" (refer to installation and operation manual of the user interface).
- When the display "change-over under centralised control" flashes, refer to ["17.5.1 About setting the master user interface" on page 55](#).
- The fan may keep on running for about 1 minute after the heating operation stops.
- The air flow rate may adjust itself depending on the room temperature or the fan may stop immediately. This is not a malfunction.

17.2.3 About the heating operation

It may take longer to reach the set temperature for general heating operation than for cooling operation.

The following operation is performed in order to prevent the heating capacity from dropping or cold air from blowing.

17 Operation

Defrost operation

In heating operation, freezing of the heat exchanger unit's air cooled coil increases over time, restricting the energy transfer to the heat exchanger unit's coil. Heating capability decreases and the system needs to go into defrost operation to be able to deliver enough heat to the indoor units.

The indoor unit will stop fan operation, the refrigerant cycle will reverse and energy from inside the building will be used to defrost the heat exchanger unit coil.

The indoor unit will indicate defrost operation on the displays .

During defrost operation, ice melts and possibly evaporates. **Possible consequence:** Mist might be visible during or directly after defrost operation. This is not a malfunction.

Hot start



In order to prevent cold air from blowing out of an indoor unit at the start of heating operation, the indoor fan is automatically stopped. The display of the user interface shows . It may take some time before the fan starts. This is not a malfunction.

INFORMATION

- The heating capacity drops when the outside temperature falls. If this happens, use another heating device together with the unit. (When using together with appliances that produce open fire, ventilate the room constantly). Do not place appliances that produce open fire in places exposed to the air flow from the unit or under the unit.
- It takes some time to heat up the room from the time the unit is started since the unit uses a hot-air circulating system to heat the entire room.
- If the hot air rises to the ceiling, leaving the area above the floor cold, we recommend that you use the circulator (the indoor fan for circulating air). Contact your dealer for details.

17.2.4 To operate the system (WITHOUT cool/heat changeover remote control switch)

- 1 Press the operation mode selector button on the user interface several times and select the operation mode of your choice.

-  Cooling operation
-  Heating operation
-  Fan only operation





- 2 Press the ON/OFF button on the user interface.

Result: The operation lamp lights up and the system starts operating.

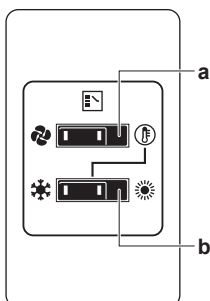
17.2.5 To operate the system (WITH cool/heat changeover remote control switch)

Overview of the changeover remote control switch



- FAN ONLY/AIR CONDITIONING SELECTOR SWITCH**
Set the switch to  for fan only operation or to  for heating or cooling operation.
- COOL/HEAT CHANGEOVER SWITCH**
Set the switch to  for cooling or to  for heating

To start

- 1 Select operation mode with the cool/heat changeover switch as follows:

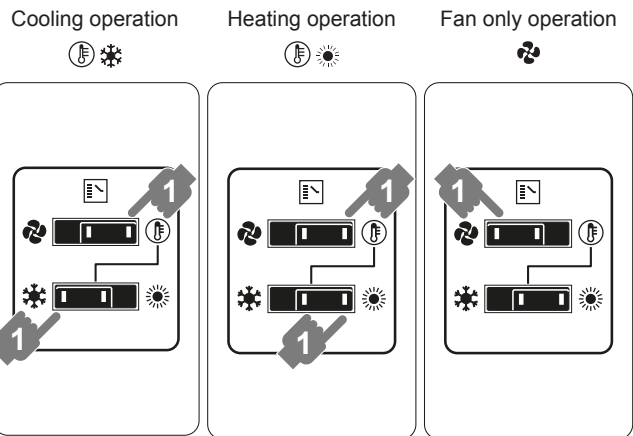

- 2 Press the ON/OFF button on the user interface.

Result: The operation lamp lights up and the system starts operating.

To stop

- 3 Press the ON/OFF button on the user interface once again.

Result: The operation lamp goes out and the system stops operating.

NOTICE

Do not turn off power immediately after the unit stops, but wait for at least 5 minutes.

To adjust

For programming temperature, fan speed and air flow direction refer to the operation manual of the user interface.

17.3 Using the dry program

17.3.1 About the dry program

- The function of this program is to decrease the humidity in your room with minimal temperature decrease (minimal room cooling).
- The micro computer automatically determines temperature and fan speed (cannot be set by the user interface).
- The system does not go into operation if the room temperature is low (<20°C).

17.3.2 To use the dry program (WITHOUT cool/heat changeover remote control switch)

To start

- 1 Press the operation mode selector button on the user interface several times and select  (program dry operation).

- 2 Press the ON/OFF button of the user interface.

Result: The operation lamp lights up and the system starts operating.

- 3 Press the air flow direction adjust button (only for double-flow, multi-flow, corner, ceiling-suspended and wall-mounted). Refer to "17.4 Adjusting the air flow direction" on page 55 for details.

To stop

- 4 Press the ON/OFF button on the user interface once again.

Result: The operation lamp goes out and the system stops operating.



NOTICE

Do not turn off power immediately after the unit stops, but wait for at least 5 minutes.

17.3.3 To use the dry program (WITH cool/heat changeover remote control switch)

To start

- 1 Select cooling operation mode with the cool/heat changeover remote control switch.

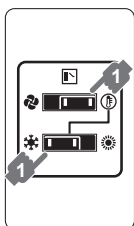

- 2 Press the operation mode selector button on the user interface several times and select  (program dry operation).
- 3 Press the ON/OFF button of the user interface.

Result: The operation lamp lights up and the system starts operating.

- 4 Press the air flow direction adjust button (only for double-flow, multi-flow, corner, ceiling-suspended and wall-mounted). Refer to "17.4 Adjusting the air flow direction" on page 55 for details.

To stop

- 5 Press the ON/OFF button on the user interface once again.

Result: The operation lamp goes out and the system stops operating.



NOTICE

Do not turn off power immediately after the unit stops, but wait for at least 5 minutes.

17.4 Adjusting the air flow direction

Refer to the operation manual of the user interface.

17.4.1 About the air flow flap

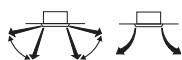

Double flow+multi-flow units

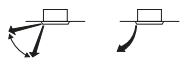

Corner units



Ceiling suspended units

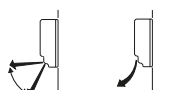



Wall-mounted units

For the following conditions, a micro computer controls the air flow direction which may be different from the display.

Cooling	Heating
<ul style="list-style-type: none"> When the room temperature is lower than the set temperature. 	<ul style="list-style-type: none"> When starting operation. When the room temperature is higher than the set temperature. At defrost operation.

Cooling	Heating
<ul style="list-style-type: none"> When operating continuously at horizontal air flow direction. 	<ul style="list-style-type: none"> When continuous operation with downward air flow is performed at the time of cooling with a ceiling-suspended or a wall-mounted unit, the micro computer may control the flow direction, and then the user interface indication will also change.

The air flow direction can be adjusted in one of the following ways:

- The air flow flap itself adjusts its position.
- The air flow direction can be fixed by the user.
- Automatic  and desired position .



WARNING

Never touch the air outlet or the horizontal blades while the swing flap is in operation. Fingers may become caught or the unit may break down.



NOTICE

- The movable limit of the flap is changeable. Contact your dealer for details. (only for double-flow, multi-flow, corner, ceiling-suspended and wall-mounted).
- Avoid operating in the horizontal direction . It may cause dew or dust to settle on the ceiling or flap.

17.5 Setting the master user interface

17.5.1 About setting the master user interface

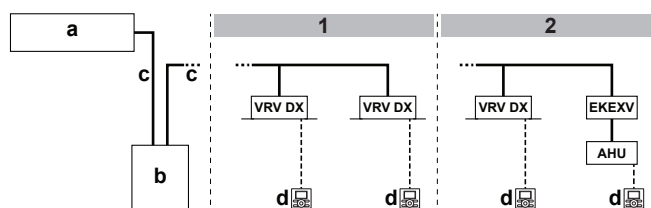

- 1 In case of VRV DX indoor units
 - 2 In case of VRV DX indoor units combined with an air handling unit
- a** Heat exchanger unit
b Compressor unit
c Refrigerant piping
d User interface (dedicated depending on indoor unit type)
VRV DX VRV direct expansion (DX) indoor unit
EKEXV Expansion valve kit
AHU Air handling unit

When the system is installed as shown in the figure above, it is necessary to designate one of the user interfaces as the master user interface.

The displays of slave user interfaces show  (change-over under centralised control) and slave user interfaces automatically follow the operation mode directed by the master user interface.

Only the master user interface can select heating or cooling mode.



17.5.2 To designate the master user interface (VRV DX)

- 1 Press the operation mode selector button of the current master user interface for 4 seconds. In case this procedure was not yet performed, the procedure can be executed on the first user interface operated.

Result: The display showing  (change-over under centralised control) of all slave user interfaces connected to the same compressor unit flashes.

- 2 Press the operation mode selector button of the controller that you wish to designate as the master user interface.

18 Energy saving and optimum operation

Result: Designation is completed. This user interface is designated as the master user interface and the display showing  (change-over under centralised control) vanishes. The displays of other user interfaces show  (change-over under centralised control).

17.5.3 About control systems

This system provides two other control systems beside individual control system (one user interface controls one indoor unit). Confirm the following if your unit is of the following control system type:

Type	Description
Group control system	One user interface controls up to 16 indoor units. All indoor units are equally set.
Two user interface control system	Two user interfaces control one indoor unit (in case of group control system, one group of indoor units). The unit is individually operated.



NOTICE

Contact your dealer in case of changing the combination or setting of group control and two user interface control systems.

18 Energy saving and optimum operation

Observe the following precautions to ensure the system operates properly.

- Adjust the air outlet properly and avoid direct air flow to room inhabitants.
- Adjust the room temperature properly for a comfortable environment. Avoid excessive heating or cooling.
- Prevent direct sunlight from entering a room during cooling operation by using curtains or blinds.
- Ventilate often. Extended use requires special attention to ventilation.
- Keep doors and windows closed. If the doors and windows remain open, air will flow out of your room causing a decrease in the cooling or heating effect.
- Be careful not to cool or heat too much. To save energy, keep the temperature setting at a moderate level.
- Never place objects near the air inlet or the air outlet of the unit. It may cause deterioration in the effect or stop the operation.
- Turn off the main power supply switch to the unit when the unit is not used for longer periods of time. If the switch is on, it consumes electricity. Before restarting the unit, turn on the main power supply switch 6 hours before operation to ensure smooth running. (Refer to "Maintenance" in the indoor unit manual.)
- When the display shows  (time to clean the air filter), ask a qualified service person to clean the filters. (Refer to "Maintenance" in the indoor unit manual.)
- Keep the compressor unit, heat exchanger unit, indoor unit and user interface at least 1 m away from televisions, radios, stereos, and other similar equipment. Failing to do so may cause static or distorted pictures.
- Do not place items under the indoor unit, they may be damaged by water.
- Condensation may form if the humidity is above 80% or if the drain outlet gets blocked.

This heat pump system is equipped with advanced energy saving functionality. Depending on the priority, emphasises can be put on energy saving or comfort level. Several parameters can be selected, resulting in the optimal balance between energy consumption and comfort for the particular application.

Several patterns are available and roughly explained below. Contact your installer or dealer for advice or to modify the parameters to the needs of your building.

Detailed information is given for the installer in the installation manual. He can help you to realize the best balance between energy consumption and comfort.

18.1 Available main operation methods

Basic

The refrigerant temperature is fixed independent from the situation. It corresponds to the standard operation which is known and can be expected from/under previous VRV systems.

Automatic

The refrigerant temperature is set depending on the outdoor ambient conditions. As such adjusting the refrigerant temperature to match the required load (which is also related to the outdoor ambient conditions).

E.g., when your system is operating in cooling, you do not need as much cooling under low outdoor ambient temperatures (e.g., 25°C) as under high outdoor ambient temperatures (e.g., 35°C). Using this idea, the system automatically starts increasing its refrigerant temperature, automatically reducing the delivered capacity and increasing the system's efficiency.

Hi-sensible/economic (cooling/heating)

The refrigerant temperature is set higher/lower (cooling/heating) compared to basic operation. The focus under high sensible mode is comfort feeling for the customer.

The selection method of indoor units is important and has to be considered as the available capacity is not the same as under basic operation.

For details concerning to Hi-sensible applications, please contact your installer.

18.2 Available comfort settings

For each of above modes a comfort level can be selected. The comfort level is related to the timing and the effort (energy consumption) which is put in achieving a certain room temperature by temporarily changing the refrigerant temperature to different values in order to achieve requested conditions more quickly.

- Powerful
- Quick
- Mild
- Eco

19 Maintenance and service



NOTICE

Never inspect or service the unit by yourself. Ask a qualified service person to perform this work.



WARNING

Never replace a fuse with a fuse of a wrong ampere ratings or other wires when a fuse blows out. Use of wire or copper wire may cause the unit to break down or cause a fire.



CAUTION

Do not insert fingers, rods or other objects into the air inlet or outlet. Do not remove the fan guard. When the fan is rotating at high speed, it will cause injury.



CAUTION

Pay attention to the fan.

It is dangerous to inspect the unit while the fan is running.

Be sure to turn off the main switch before executing any maintenance task.



CAUTION

After a long use, check the unit stand and fitting for damage. If damaged, the unit may fall and result in injury.



NOTICE

Do not wipe the controller operation panel with benzine, thinner, chemical dust cloth, etc. The panel may get discoloured or the coating peeled off. If it is heavily dirty, soak a cloth in water-diluted neutral detergent, squeeze it well and wipe the panel clean. Wipe it with another dry cloth.



NOTICE

In Europe, the **greenhouse gas emissions** of the total refrigerant charge in the system (expressed as tonnes CO₂-equivalent) is used to determine the maintenance intervals. Follow the applicable legislation.

Formula to calculate the greenhouse gas emissions:
GWP value of the refrigerant × Total refrigerant charge [in kg] / 1000

Please contact your installer for more information.



WARNING

The refrigerant in the system is safe and normally does not leak. If the refrigerant leaks in the room, contact with a fire of a burner, a heater or a cooker may result in a harmful gas.

Turn off any combustible heating devices, ventilate the room and contact the dealer where you purchased the unit.

Do not use the system until a service person confirms that the portion where the refrigerant leaks is repaired.

19.1 Maintenance after a long stop period

E.g., at the beginning of the season.

- Check and remove everything that might be blocking inlet and outlet vents of indoor units and heat exchanger unit.
- Clean air filters and casings of indoor units and heat exchanger unit. Contact your installer or maintenance person to clean the air filters and casings of the indoor units and the heat exchanger unit. Maintenance tips and procedures for cleaning are provided in the installation/operation manuals of dedicated indoor units. Make sure to install cleaned air filters back in the same position.
- Turn on the power at least 6 hours before operating the unit in order to ensure smoother operation. As soon as the power is turned on, the user interface display appears.

19.2 Maintenance before a long stop period

E.g., at the end of the season.

- Let the indoor units run in fan only operation for about half a day in order to dry the interior of the units. Refer to "[17.2.2 About cooling, heating, fan only, and automatic operation](#)" on page 53 for details on fan only operation.
- Turn off the power. The user interface display disappears.
- Clean air filters and casings of indoor units and heat exchanger unit. Contact your installer or maintenance person to clean the air filters and casings of the indoor units and the heat exchanger unit. Maintenance tips and procedures for cleaning are provided in the installation/operation manuals of dedicated indoor units. Make sure to install cleaned air filters back in the same position.

19.3 About the refrigerant

This product contains fluorinated greenhouse gases. Do NOT vent gases into the atmosphere.

Refrigerant type: R410A

Global warming potential (GWP) value: 2087.5

19.4 After-sales service and warranty

19.4.1 Warranty period

- This product includes a warranty card that was filled in by the dealer at the time of installation. The completed card has to be checked by the customer and stored carefully.
- If repairs to the product are necessary within the warranty period, contact your dealer and keep the warranty card at hand.

19.4.2 Recommended maintenance and inspection

Since dust collects when using the unit for several years, performance of the unit will deteriorate to some extent. As taking apart and cleaning interiors of units requires technical expertise and in order to ensure the best possible maintenance of your units, we recommend to enter into a maintenance and inspection contract on top of normal maintenance activities. Our network of dealers has access to a permanent stock of essential components in order to keep your unit in operation as long as possible. Contact your dealer for more information.

When asking your dealer for an intervention, always state:

- The complete model name of the unit.
- The manufacturing number (stated on the nameplate of the unit).
- The installation date.
- The symptoms or malfunction, and details of the defect.



WARNING

- Do not modify, disassemble, remove, reinstall or repair the unit yourself as incorrect dismantling or installation may cause an electric shock or fire. Contact your dealer.
- In case of accidental refrigerant leaks, make sure there are no naked flames. The refrigerant itself is entirely safe, non-toxic and non-combustible, but it will generate toxic gas when it accidentally leaks into a room where combustible air from fan heaters, gas cookers, etc. is present. Always have qualified service personnel confirm that the point of leakage has been repaired or corrected before resuming operation.

20 Troubleshooting

19.4.3 Recommended maintenance and inspection cycles

Be aware that the mentioned maintenance and replacement cycles do not relate to the warranty period of the components.

Component	Inspection cycle	Maintenance cycle (replacements and/or repairs)
Electric motor	1 year	20,000 hours
PCB		25,000 hours
Heat exchanger		5 years
Sensor (thermistor, etc.)		5 years
User interface and switches		25,000 hours
Drain pan		8 years
Expansion valve		20,000 hours
Solenoid valve		20,000 hours

The table assumes the following conditions of use:

- Normal use without frequent starting and stopping of the unit. Depending on the model, we recommend not starting and stopping the machine more than 6 times/hour.
- Operation of the unit is assumed to be 10 hours/day and 2,500 hours/year.

NOTICE

- The table indicates main components. Refer to your maintenance and inspection contract for more details.
- The table indicates recommended intervals of maintenance cycles. However, in order to keep the unit operational as long as possible, maintenance work may be required sooner. Recommended intervals can be used for appropriate maintenance design in terms of budgeting maintenance and inspection fees. Depending on the content of the maintenance and inspection contract, inspection and maintenance cycles may in reality be shorter than listed.

19.4.4 Shortened maintenance and replacement cycles

Shortening of "maintenance cycle" and "replacement cycle" needs to be considered in following situations:

The unit is used in locations where:

- Heat and humidity fluctuate out of the ordinary.
- Power fluctuation is high (voltage, frequency, wave distortion, etc.) (the unit cannot be used if power fluctuation is outside the allowable range).
- Bumps and vibrations are frequent.
- Dust, salt, harmful gas or oil mist such as sulphurous acid and hydrogen sulfide may be present in the air.
- The machine is started and stopped frequently or operation time is long (sites with 24 hour air-conditioning).

Recommended replacement cycle of wear parts

Component	Inspection cycle	Maintenance cycle (replacements and/or repairs)
Air filter	1 year	5 years
High efficiency filter		1 year
Fuse		10 years
Pressure containing parts		In case of corrosion, contact your local dealer.

NOTICE

- The table indicates main components. Refer to your maintenance and inspection contract for more details.
- The table indicates recommended intervals of replacement cycles. However, in order to keep the unit operational as long as possible, maintenance work may be required sooner. Recommended intervals can be used for appropriate maintenance design in terms of budgeting maintenance and inspection fees. Contact your dealer for details.

INFORMATION

Damage due to taking apart or cleaning interiors of units by anyone other than our authorised dealers may not be included in the warranty.

20 Troubleshooting

If one of the following malfunctions occur, take the measures shown below and contact your dealer.

WARNING

Stop operation and shut off the power if anything unusual occurs (burning smells etc.).

Leaving the unit running under such circumstances may cause breakage, electric shock or fire. Contact your dealer.

The system must be repaired by a qualified service person:

Malfunction	Measure
If a safety device such as a fuse, a breaker or an earth leakage breaker frequently actuates or the ON/OFF switch does not properly work.	Turn off the main power switch.
If water leaks from the unit.	Stop the operation.
The operation switch does not work well.	Turn off the power.
If the user interface display indicates the unit number, the operation lamp flashes and the malfunction code appears.	Notify your installer and report the malfunction code.

If the system does not properly operate except for the above mentioned cases and none of the above mentioned malfunctions is evident, investigate the system according to the following procedures.

Malfunction	Measure
If the system does not operate at all.	<ul style="list-style-type: none"> • Check if there is no power failure. Wait until power is restored. If power failure occurs during operation, the system automatically restarts immediately after the power supply is recovered. • Check if no fuse has blown or breaker has worked. Change the fuse or reset the breaker if necessary.
If the system goes into fan only operation, but as soon as it goes into heating or cooling operation, the system stops.	<ul style="list-style-type: none"> • Check if air inlet or outlet of heat exchanger unit or indoor unit is not blocked by obstacles. Remove any obstacle and make it well-ventilated. • Check if the user interface display shows  (time to clean the air filter). (Refer to "19 Maintenance and service" on page 56 and "Maintenance" in the indoor unit manual.)

Malfunction	Measure
The system operates but cooling or heating is insufficient.	<ul style="list-style-type: none"> ▪ Check if air inlet or outlet of heat exchanger unit or indoor unit is not blocked by obstacles. Remove any obstacle and make it well-ventilated. ▪ Check if the air filter is not clogged (refer to "Maintenance" in the indoor unit manual). ▪ Check the temperature setting. ▪ Check the fan speed setting on your user interface. ▪ Check for open doors or windows. Shut doors and windows to prevent wind from coming in. ▪ Check if there are too many occupants in the room during cooling operation. Check if the heat source of the room is excessive. ▪ Check if direct sunlight enters the room. Use curtains or blinds. ▪ Check if the air flow angle is proper.

If after checking all above items, it is impossible to fix the problem yourself, contact your installer and state the symptoms, the complete model name of the unit (with manufacturing number if possible) and the installation date (possibly listed on the warranty card).

20.1 Error codes: Overview

In case a malfunction code appears on the indoor unit user interface display, contact your installer and inform the malfunction code, the unit type, and serial number (you can find this information on the nameplate of the unit).

For your reference, a list with malfunction codes is provided. You can, depending on the level of the malfunction code, reset the code by pushing the ON/OFF button. If not, ask your installer for advice.

Main code	Contents
<i>R0</i>	External protection device was activated
<i>R1</i>	EEPROM failure (indoor)
<i>R3</i>	Drain system malfunction (indoor)
<i>Rb</i>	Fan motor malfunction (indoor)
<i>R7</i>	Swing flap motor malfunction (indoor)
<i>R9</i>	Expansion valve malfunction (indoor)
<i>RF</i>	Drain malfunction (indoor unit)
<i>RH</i>	Filter dust chamber malfunction (indoor)
<i>RJ</i>	Capacity setting malfunction (indoor)
<i>C1</i>	Transmission malfunction between main PCB and sub PCB (indoor)
<i>C4</i>	Heat exchanger thermistor malfunction (indoor; liquid)
<i>C5</i>	Heat exchanger thermistor malfunction (indoor; gas)
<i>C9</i>	Suction air thermistor malfunction (indoor)
<i>CR</i>	Discharge air thermistor malfunction (indoor)
<i>CE</i>	Movement detector or floor temperature sensor malfunction (indoor)
<i>CJ</i>	User interface thermistor malfunction (indoor)
<i>E0</i>	Fan or drain pump malfunction (heat exchanger unit)
<i>E1</i>	PCB malfunction (compressor unit)
<i>E2</i>	Current leakage detector was activated (compressor unit)
<i>E3</i>	High pressure switch was activated
<i>E4</i>	Low pressure malfunction (compressor unit)

Main code	Contents
<i>E5</i>	Compressor lock detection (compressor unit)
<i>E9</i>	Electronic expansion valve malfunction (compressor unit or heat exchanger unit)
<i>F3</i>	Discharge temperature malfunction (compressor unit)
<i>F4</i>	Abnormal suction temperature (compressor unit)
<i>Fb</i>	Refrigerant overcharge detection
<i>H3</i>	High pressure switch malfunction
<i>H4</i>	Low pressure switch malfunction
<i>H9</i>	Ambient temperature sensor malfunction (heat exchanger unit)
<i>J1</i>	Pressure sensor malfunction
<i>J2</i>	Current sensor malfunction
<i>J3</i>	Discharge temperature sensor malfunction (compressor unit)
<i>J4</i>	Heat exchanger gas temperature sensor malfunction (heat exchanger unit)
<i>J5</i>	Suction temperature sensor malfunction (compressor unit)
<i>Jb</i>	De-icing temperature sensor malfunction (heat exchanger unit)
<i>J7</i>	Liquid temperature sensor (after subcool HE) malfunction (compressor unit)
<i>J9</i>	Gas temperature sensor (after subcool HE) malfunction (compressor unit)
<i>JR</i>	High pressure sensor malfunction (BIPH)
<i>JL</i>	Low pressure sensor malfunction (BIPL)
<i>L1</i>	INV PCB abnormal
<i>L4</i>	Fin temperature abnormal
<i>L5</i>	Inverter PCB faulty
<i>LB</i>	Compressor over current detected
<i>L9</i>	Compressor lock (startup)
<i>LC</i>	Transmission compressor unit - inverter: INV transmission trouble
<i>P1</i>	INV unbalanced power supply voltage
<i>P4</i>	Fin thermistor malfunction
<i>PJ</i>	Heat exchanger unit capacity setting malfunction.
<i>U0</i>	Abnormal low pressure drop, faulty expansion valve
<i>U1</i>	Reversed power supply phase malfunction
<i>U2</i>	INV voltage power shortage
<i>U3</i>	System test run not yet executed
<i>U4</i>	Faulty wiring indoor/heat exchanger unit/compressor unit
<i>U5</i>	Abnormal user interface - indoor communication
<i>UB</i>	Abnormal main-sub user interface communication
<i>U9</i>	System mismatch. Wrong type of indoor units combined. Indoor unit malfunction. Heat exchanger unit malfunction.
<i>UR</i>	Connection malfunction over indoor units or type mismatch (wrong type of indoor units or heat exchanger unit)
<i>UC</i>	Centralised address duplication
<i>UE</i>	Malfunction in communication centralised control device - indoor unit
<i>UF</i>	Auto address malfunction (inconsistency)
<i>UH</i>	Auto address malfunction (inconsistency)

20 Troubleshooting



20.2 Symptoms that are NOT system malfunctions

The following symptoms are NOT system malfunctions:

20.2.1 Symptom: The system does not operate

- The air conditioner does not start immediately after the ON/OFF button on the user interface is pressed. If the operation lamp lights, the system is in normal condition. To prevent overloading of the compressor motor, the air conditioner starts 5 minutes after it is turned ON again in case it was turned OFF just before. The same starting delay occurs after the operation mode selector button was used.
- If "Under Centralized Control" is displayed on the user interface, pressing the operation button causes the display to blink for a few seconds. The blinking display indicates that the user interface cannot be used.
- The system does not start immediately after the power supply is turned on. Wait one minute until the micro computer is prepared for operation.

20.2.2 Symptom: Cool/Heat cannot be changed over

- When the display shows  (change-over under centralized control), it shows that this is a slave user interface.
- When the cool/heat changeover remote control switch is installed and the display shows  (change-over under centralized control), this is because cool/heat changeover is controlled by the cool/ heat changeover remote control switch. Ask your dealer where the remote control switch is installed.

20.2.3 Symptom: Fan operation is possible, but cooling and heating do not work

Immediately after the power is turned on. The micro computer is getting ready to operate and is performing a communication check with all indoor units. Please wait 12 minutes (max.) till this process is finished.

20.2.4 Symptom: The fan strength does not correspond to the setting

The fan speed does not change even if the fan speed adjustment button is pressed. During heating operation, when the room temperature reaches the set temperature, the compressor unit goes off and the indoor unit changes to whisper fan speed. This is to prevent cold air blowing directly on occupants of the room. The fan speed will not change even when another indoor unit is in heating operation, if the button is pressed.

20.2.5 Symptom: The fan direction does not correspond to the setting

The fan direction does not correspond with the user interface display. The fan direction does not swing. This is because the unit is being controlled by the micro computer.

20.2.6 Symptom: White mist comes out of a unit (Indoor unit)

- When humidity is high during cooling operation. If the interior of an indoor unit is extremely contaminated, the temperature distribution inside a room becomes uneven. It is necessary to clean the interior of the indoor unit. Ask your dealer for details on cleaning the unit. This operation requires a qualified service person.

- Immediately after the cooling operation stops and if the room temperature and humidity are low. This is because warm refrigerant gas flows back into the indoor unit and generates steam.

20.2.7 Symptom: White mist comes out of a unit (Indoor unit, heat exchanger unit)

When the system is changed over to heating operation after defrost operation. Moisture generated by defrost becomes steam and is exhausted.

20.2.8 Symptom: The user interface display reads "U4" or "U5" and stops, but then restarts after a few minutes

This is because the user interface is intercepting noise from electric appliances other than the air conditioner. The noise prevents communication between the units, causing them to stop. Operation automatically restarts when the noise ceases.

20.2.9 Symptom: Noise of air conditioners (Indoor unit, heat exchanger unit)

- A "zeen" sound is heard immediately after the power supply is turned on. The electronic expansion valve inside an indoor unit starts working and makes the noise. Its volume will reduce in about one minute.
- A continuous low "shah" sound is heard when the system is in cooling operation or at a stop. When the drain pump (optional accessories) is in operation, this noise is heard.
- A "pishi-pishi" squeaking sound is heard when the system stops after heating operation. Expansion and contraction of plastic parts caused by temperature change make this noise.
- A low "sah", "choro-choro" sound is heard while the indoor unit is stopped. When another indoor unit is in operation, this noise is heard. In order to prevent oil and refrigerant from remaining in the system, a small amount of refrigerant is kept flowing.

20.2.10 Symptom: Noise of air conditioners (Indoor unit, compressor unit, heat exchanger unit)

- A continuous low hissing sound is heard when the system is in cooling or defrost operation. This is the sound of refrigerant gas flowing through the compressor unit, heat exchanger unit and indoor units.
- A hissing sound which is heard at the start or immediately after stopping operation or defrost operation. This is the noise of refrigerant caused by flow stop or flow change.

20.2.11 Symptom: Noise of air conditioners (compressor unit, heat exchanger unit)

When the tone of operating noise changes. This noise is caused by the change of frequency from the compressor or the fans.

20.2.12 Symptom: Dust comes out of the heat exchanger unit

When the unit is used for the first time in a long time. This is because dust has gotten into the heat exchanger unit.

20.2.13 Symptom: The units can give off odours

The unit can absorb the smell of rooms, furniture, cigarettes, etc., and then emit it again.

20.2.14 Symptom: The heat exchanger unit fan does not spin

During operation. The speed of the fan is controlled in order to optimise product operation.

20.2.15 Symptom: The display shows "88"

This is the case immediately after the main power supply switch is turned on and means that the user interface is in normal condition. This continues for one minute.

20.2.16 Symptom: The compressor in the compressor unit does not stop after a short heating operation

This is to prevent refrigerant from remaining in the compressor. The unit will stop after 5 to 10 minutes.

20.2.17 Symptom: The inside of an compressor unit is warm even when the unit has stopped

This is because the crankcase heater is warming the compressor so that the compressor can start smoothly.

20.2.18 Symptom: Hot air can be felt when the indoor unit is stopped

Several different indoor units are being run on the same system. When another unit is running, some refrigerant will still flow through the unit.

Installation manual

Instruction manual specified for a certain product or application, explaining how to install, configure and maintain it.

Operation manual

Instruction manual specified for a certain product or application, explaining how to operate it.

Accessories

Labels, manuals, information sheets and equipment that are delivered with the product and that need to be installed according to the instructions in the accompanying documentation.

Optional equipment

Equipment made or approved by Daikin that can be combined with the product according to the instructions in the accompanying documentation.

Field supply

Equipment not made by Daikin that can be combined with the product according to the instructions in the accompanying documentation.

21 Relocation

Contact your dealer for removing and reinstalling the total unit. Moving units requires technical expertise.

22 Disposal

This unit uses hydrofluorocarbon. Contact your dealer when discarding this unit. It is required by law to collect, transport and discard the refrigerant in accordance with the "hydrofluorocarbon collection and destruction" regulations.

23 Glossary

Dealer

Sales distributor for the product.

Authorized installer

Technical skilled person who is qualified to install the product.

User

Person who is owner of the product and/or operates the product.

Applicable legislation

All international, European, national and local directives, laws, regulations and/or codes that are relevant and applicable for a certain product or domain.

Service company

Qualified company which can perform or coordinate the required service to the product.

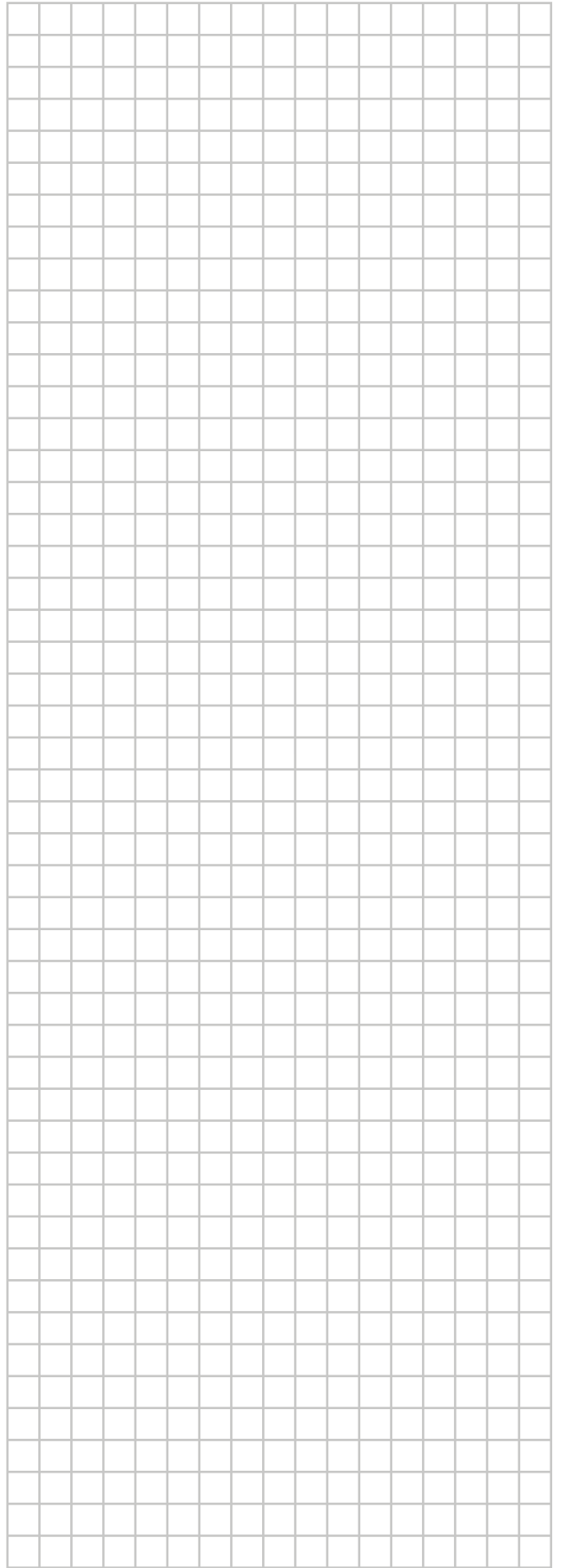
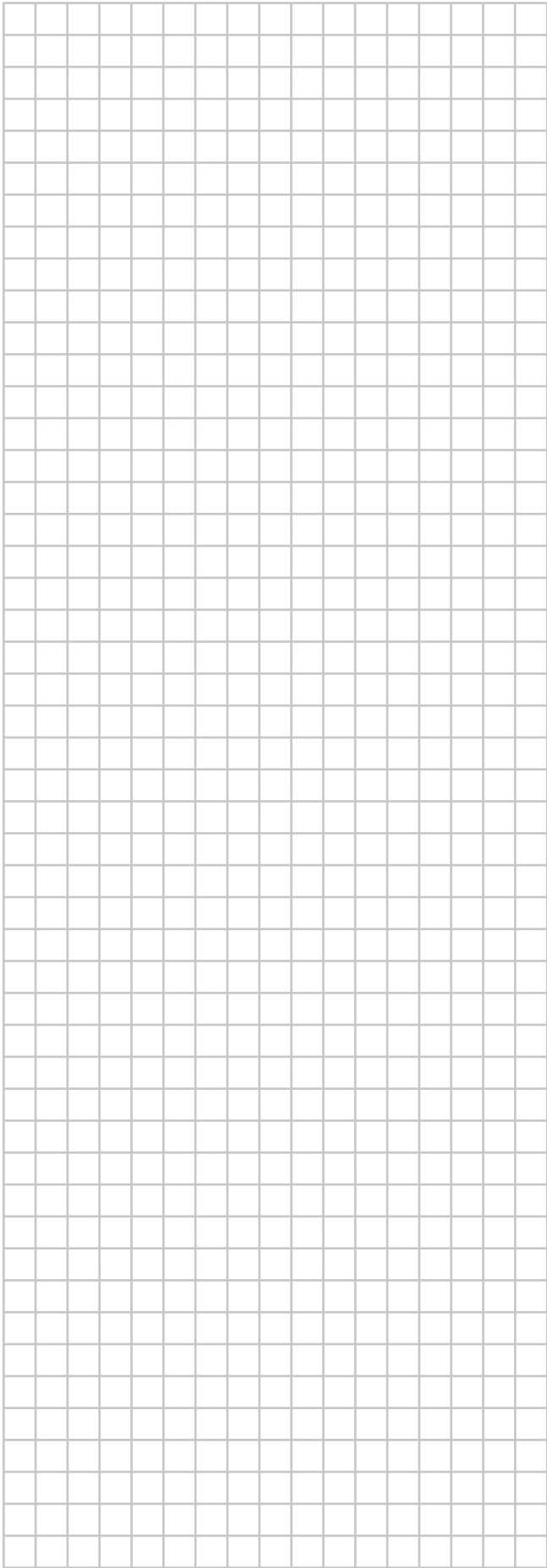

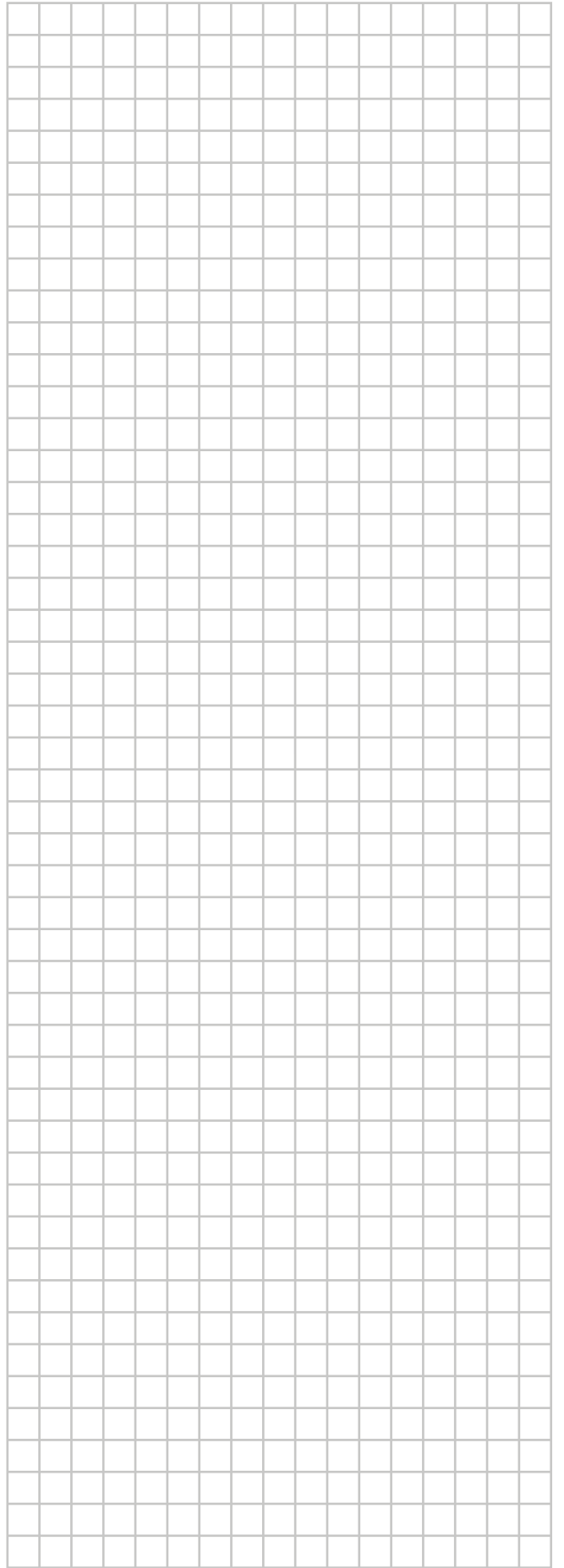

ERC

Copyright 2015 Daikin