



DAIKIN ROOM AIR CONDITIONER

OPERATION MANUAL



MODELS

- ATXB25C2V1B
- ATXB35C2V1B

CONTENTS

READ BEFORE OPERATION

Safety Precautions 2
Names of Parts 4
Preparation before Operation 7

OPERATION

AUTO · DRY · COOL · HEAT ·
FAN Operation 9
Adjusting the Airflow Direction 11
COMFORT AIRFLOW Operation 13
POWERFUL Operation 14
ECONO Operation 15
OFF TIMER Operation 16
ON TIMER Operation 17

CARE

Care and Cleaning 18

TROUBLESHOOTING

Troubleshooting 22

Safety Precautions

- Keep this manual where the operator can easily find them.
- Read this manual attentively before starting up the unit.
- For safety reason the operator must read the following cautions carefully.
- This manual classifies precautions into WARNINGS and CAUTIONS. Be sure to follow all precautions below: they are all important for ensuring safety.
- The English text is the original instruction. Other languages are translations of the original instructions.

WARNING

If you do not follow these instructions exactly, the unit may cause property damage, personal injury or loss of life.

CAUTION

If you do not follow these instructions exactly, the unit may cause minor or moderate property damage or personal injury.



Never do.



Be sure to earth the air conditioner.



Never touch the air conditioner (including the remote controller) with a wet hand.



Be sure to follow the instructions.



Never cause the air conditioner (including the remote controller) to get wet.



WARNING

- In order to avoid fire, explosion or injury, do not operate the unit when harmful gases (e.g. flammable or corrosive) are detected near the unit.
- It is not good for health to expose your body to the air flow for a long time.
- Do not put a finger, a rod or other objects into the air outlet or inlet. As the fan is rotating at a high speed, it will cause injury.
- Do not attempt to repair, relocate, modify or reinstall the air conditioner by yourself. Incorrect work will cause electric shocks, fire etc.
- For repairs and reinstallation, consult your Daikin dealer for advice and information.

• The refrigerant used in the air conditioner is safe. Although leaks should not occur, if for some reason any refrigerant happens to leak into the room, make sure it does not come in contact with any flame as of gas heaters, kerosene heaters or gas range.

- If the air conditioner is not cooling (heating) properly, the refrigerant may be leaking, so call your dealer. When carrying out repairs accompanying adding refrigerant, check the content of the repairs with our service staff.
- Do not attempt to install the air conditioner by yourself. Incorrect work will result in water leakage, electric shocks or fire.

For installation, consult the dealer or a qualified technician.

- In order to avoid electric shock, fire or injury, if you detect any abnormality such as smell of fire, stop the operation and turn off the breaker. And call your dealer for instructions.
- Depending on the environment, an earth leakage breaker must be installed. Lack of an earth leakage breaker may result in electric shocks or fire.

• The air conditioner must be earthed. Incomplete earthing may result in electric shocks. Do not connect the earth line to a gas pipe, water pipe, lightning rod, or a telephone earth line.



CAUTION

- In order to avoid any quality deterioration, do not use the unit for cooling precision instruments, food, plants, animals or works of art.
- Never expose little children, plants or animals directly to the air flow.
- Do not place appliances which produce open fire in places exposed to the air flow from the unit or under the indoor unit. It may cause incomplete combustion or deformation of the unit due to the heat.



- Do not block air inlets nor outlets. Impaired air flow may result in insufficient performance or trouble.
- Do not stand or sit on the outdoor unit. Do not place any object on the unit to avoid injury, do not remove the fan guard.
- Do not place anything under the indoor or outdoor unit that must be kept away from moisture. In certain conditions, moisture in the air may condense and drip.
- After a long use, check the unit stand and fittings for damage.
- Do not touch the air inlet and aluminium fins of outdoor unit. It may cause injury.
- This appliance can be used by children aged from 8 years and above and persons with reduced physical, sensory or mental capabilities or lack of experience and knowledge if they have been given supervision or instruction concerning use of the appliance in a safe way and understand the hazards involved.
- Children shall not play with the appliance.
- Cleaning and user maintenance shall not be made by children without supervision.
- This appliance is intended to be used by expert or trained users in shops, in light industry and on farms, or for commercial and household use by lay persons.
- Sound pressure level is less than 70 dB(A).

-
- To avoid oxygen deficiency, ventilate the room sufficiently if equipment with burner is used together with the air conditioner. 
 - Before cleaning, be sure to stop the operation, turn the breaker off or pull out the supply cord.
 - Do not connect the air conditioner to a power supply different from the one as specified. It may cause trouble or fire.
 - Arrange the drain hose to ensure smooth drainage. Incomplete draining may cause wetting of the building, furniture etc.
 - Do not place objects in direct proximity of the outdoor unit and do not let leaves and other debris accumulate around the unit.
Leaves are a hotbed for small animals which can enter the unit. Once in the unit, such animals can cause malfunctions, smoke or fire when making contact with electrical parts.

-
- Do not operate the air conditioner with wet hands. 

-
- Do not wash the indoor unit with excessive water, only use a slightly wet cloth. 
 - Do not place things such as vessels containing water or anything else on top of the unit. Water may penetrate into the unit and degrade electrical insulations, resulting in an electric shock.

Installation site.

- To install the air conditioner in the following types of environments, consult the dealer.
 - Places with an oily environment or where steam or soot occurs.
 - Salty environment such as coastal areas.
 - Places where sulfide gas occurs such as hot springs.
 - Places where snow may block the outdoor unit.

The drain from the outdoor unit must be discharged to a place of good drainage.

Consider nuisance to your neighbours from noises.

- For installation, choose a place as described below.
 - A place solid enough to bear the weight of the unit which does not amplify the operation noise or vibration.
 - A place from where the air discharged from the outdoor unit or the operation noise will not annoy your neighbours.

Electrical work.

- For power supply, be sure to use a separate power circuit dedicated to the air conditioner.

System relocation.

- Relocating the air conditioner requires specialised knowledge and skills. Please consult the dealer if relocation is necessary for moving or remodeling.

Names of Parts

■ Indoor Unit

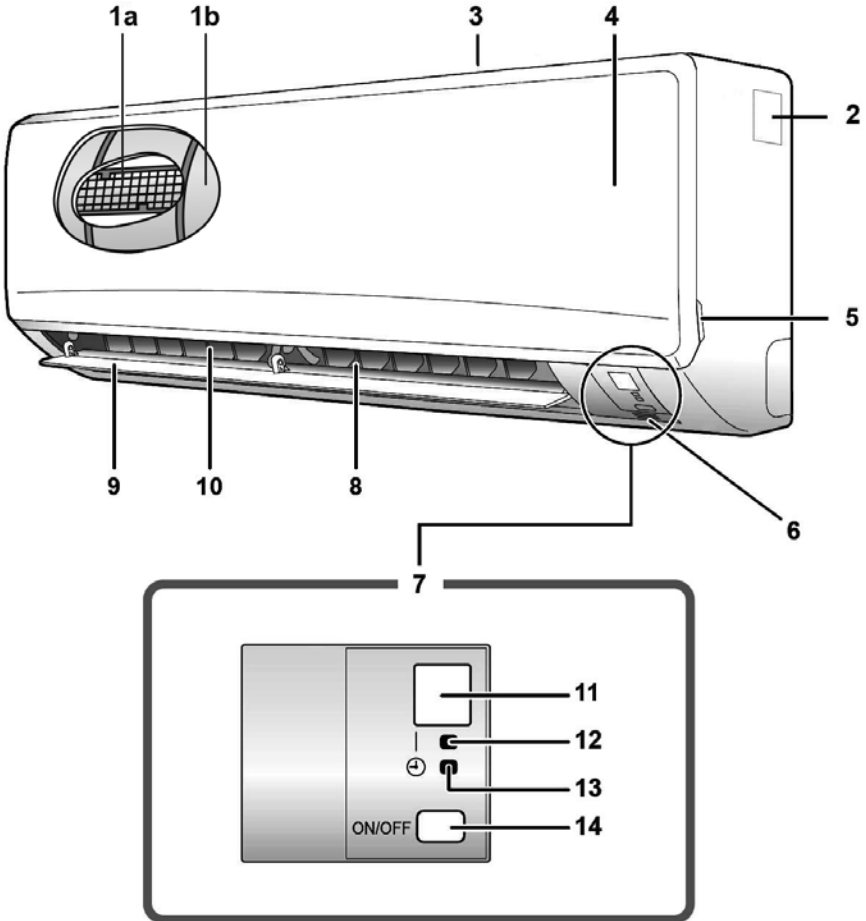

■ Outdoor Unit

- Appearance of the outdoor unit may differ from some models.

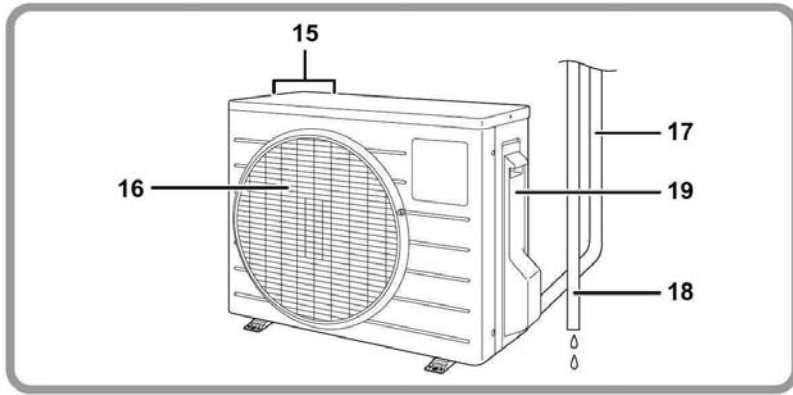

■ Indoor Unit

1a. Air filter

1b. Titanium apatite deodorizing filter:

- These filters are attached to the inside of the air filters.

2. Model name plate

3. Air inlet

4. Front panel

5. Panel tab

6. Room temperature sensor:

- It senses the air temperature around the unit.

7. Display

8. Air outlet

9. Flap (horizontal blade): (page 11)

10. Louvers (vertical blades):

- The louvers are inside of the air outlet. (page 12)

11. Signal receiver:

- It receives signals from the remote controller.
- When the unit receives a signal, you will hear a beep sound.
 - Operation startbeep-beep
 - Settings changedbeep
 - Operation stoplong beep

12. OPERATION lamp (green)

13. TIMER lamp (yellow): (page 16)

14. Indoor unit ON/OFF switch:

- Press this switch once to start operation. Press once again to stop it.
- The operation mode refers to the following table.

| Mode | Temperature setting | Airflow rate |
|------|---------------------|--------------|
| AUTO | 25°C | AUTO |

- This switch is useful when the remote controller is missing

■ Outdoor Unit

15. Air inlet (back and side)

16. Air outlet

17. Refrigerant piping and inter-unit wiring

18. Drain hose

19. Earth terminal:

- It is inside of this cover.

Names of Parts

■ Remote Controller

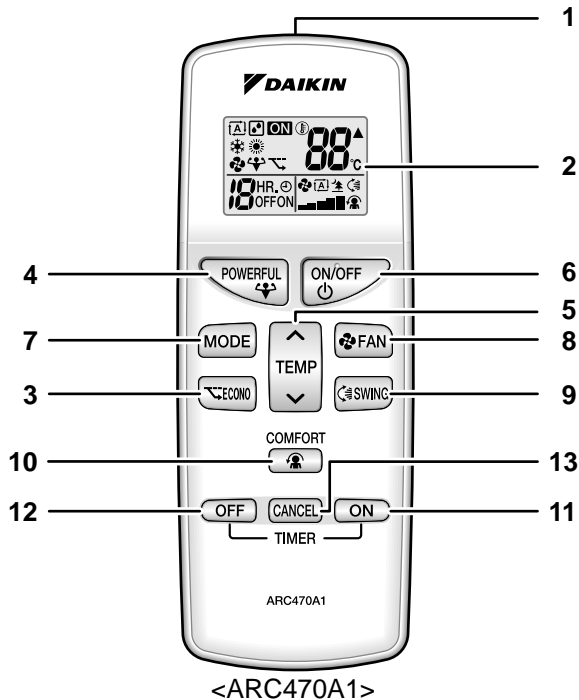

1. Signal transmitter:

- It sends signals to the indoor unit.

2. Display (LCD):

- It displays the current settings.
(In this illustration, each section is shown with its displays on for the purpose of explanation.)

3. ECONO button:

ECONO operation (page 15)

4. POWERFUL button:

POWERFUL operation (page 14)

5. TEMPERATURE adjustment button:

- It changes the temperature setting.

6. ON/OFF button:

- Press this button once to start operation.
Press once again to stop it.

7. MODE selector button:

- It selects the operation mode.
(AUTO/DRY/COOL/HEAT/FAN) (page 9)

8. FAN setting button:

- It selects the airflow rate setting.

9. SWING button:

- Adjusting the airflow direction. (page 11)

10. COMFORT AIRFLOW button:

COMFORT AIRFLOW operation (page 13)

11. ON TIMER button:

(page 17)

12. OFF TIMER button:

(page 16)

13. TIMER CANCEL button:

- It cancels the timer setting.

Preparation before Operation

■ To set the batteries

1. Remove the back cover by sliding and then slightly lifting it.
2. Set two dry batteries AAA.LR03 (alkaline).
3. Return the back cover to the previous position.

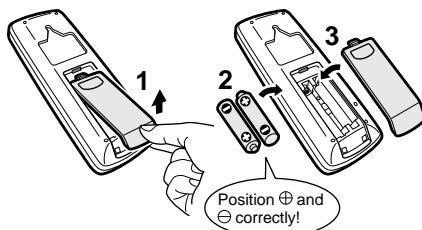

■ To operate the remote controller

- To use the remote controller, aim the transmitter at the indoor unit. If there is anything to block signals between the unit and the remote controller, such as a curtain, the unit will not operate.
- Do not drop the remote controller. Do not get it wet.
- The maximum distance for communication is approximately 7m.

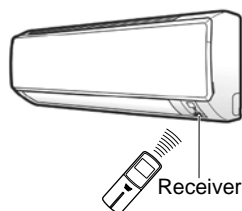

■ To fix the remote controller holder on the wall

1. Choose a place from where the signals reach the unit.
2. Fix the holder to a wall, a pillar, or similar location with the screws procured locally.
3. Hang the remote controller on the remote controller holder.

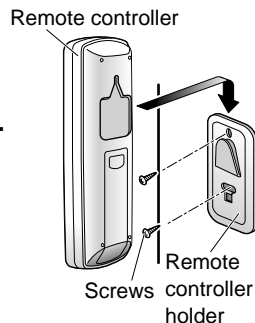

NOTE

■ Notes on batteries

- When replacing the batteries, use batteries of the same type, and replace both old batteries together.
- When the system is not used for a long time, take the batteries out.
- The batteries will last for approximately 1 year. If the remote controller display begins to fade and the degradation of reception performance occurs within a year, however, replace both batteries with new, size AAA.LR03 (alkaline).
- The attached batteries are provided for the initial use of the system.
The usable period of the batteries may be short depending on the manufactured date of the air conditioner.

■ Notes on remote controller

- Never expose the remote controller to direct sunlight.
- Dust on the signal transmitter or receiver will reduce the sensitivity. Wipe off dust with soft cloth.
- Signal communication may be disabled if an electronic-starter-type fluorescent lamp (such as inverter-type lamps) is in the room. Consult the shop if that is the case.
- If the remote controller signals happen to operate another appliance, move that appliance to somewhere else, or consult the shop.

Preparation before Operation

■ Turn the breaker on

- After the power is turned on, the flap of the indoor unit opens and closes once to set the reference position.

NOTE

■ Tips for saving energy

- Be careful not to cool (heat) the room too much. Keeping the temperature setting at a moderate level helps save energy.
- Cover windows with a blind or a curtain. Blocking sunlight and air from outdoors increases the cooling (heating) effect.
- Clogged air filters cause inefficient operation and waste energy. Clean them once in about every 2 weeks.

| Recommended temperature setting |
|---------------------------------|
| For cooling: 26 – 28°C |
| For heating: 20 – 24°C |

■ Please note

- The air conditioner always consumes 15 – 35W of electricity even while it is not operating.
- If you are not going to use the air conditioner for a long period, for example in spring or autumn, turn the breaker off.
- Use the air conditioner in the following conditions.

| Mode | Operating conditions | If operation is continued out of this range |
|------|---|--|
| COOL | Outdoor temperature: -10 – 46°C Indoor temperature: 18 – 32°C Indoor humidity: 80% max. | <ul style="list-style-type: none"> • A safety device may work to stop the operation. • Condensation may occur on the indoor unit and drip. |
| HEAT | Outdoor temperature: -15 – 24°C Indoor temperature: 10 – 30°C | <ul style="list-style-type: none"> • A safety device may work to stop the operation. |
| DRY | Outdoor temperature: -10 – 46°C Indoor temperature: 18 – 32°C Indoor humidity: 80% max. | <ul style="list-style-type: none"> • A safety device may work to stop the operation. • Condensation may occur on the indoor unit and drip. |

- Operation outside this humidity or temperature range may cause a safety device to disable the system.

AUTO · DRY · COOL · HEAT · FAN Operation

The air conditioner operates with the operation mode of your choice. From the next time on, the air conditioner will operate with the same operation mode.

■ To start operation

1. Press **MODE** and select a operation mode.

- Each pressing of the button advances the mode setting in sequence.

 : AUTO  : HEAT
 : DRY  : FAN
 : COOL

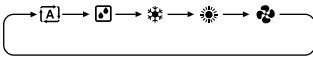

2. Press **ON/OFF**.

- “**ON**” is displayed on the LCD.
- The OPERATION lamp lights up.

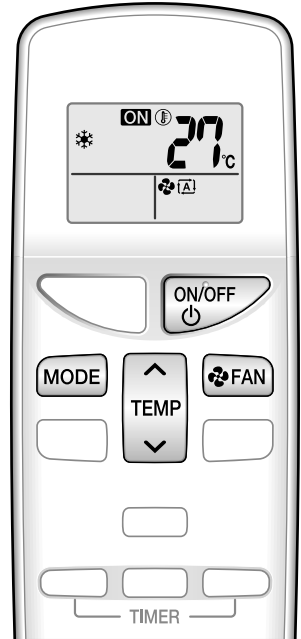
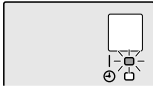

■ To stop operation



3. Press **ON/OFF** again.

- “**ON**” disappears from the LCD.
- Then OPERATION lamp goes off.

■ To change the temperature setting

4. Press **TEMP**.



| AUTO or COOL or HEAT operation | DRY or FAN operation |
|--|--|
| Press  to raise the temperature and press  to lower the temperature. | The temperature setting is not variable. |
| Set to the temperature you like.  | |

AUTO · DRY · COOL · HEAT · FAN Operation

■ To change the airflow rate setting

5. Press .

| AUTO or COOL or HEAT or FAN operation | DRY operation |
|--|---|
| 5 levels of airflow rate setting from “=” to “■” plus “  | The airflow rate setting is not variable. |

- Indoor unit quiet operation

When the airflow is set to “

NOTE

■ Notes on HEAT operation

- Since this air conditioner heats the room by taking heat from outdoor air to indoors, the heating capacity becomes smaller in lower outdoor temperatures. If the heating effect is insufficient, it is recommended to use another heating appliance in combination with the air conditioner.
- The heat pump system heats the room by circulating hot air around all parts of the room. After the start of HEAT operation, it takes some time before the room gets warmer.
- In HEAT operation, frost may occur on the outdoor unit and lower the heating capacity. In that case, the system switches into defrosting operation to take away the frost.
- During defrosting operation, hot air does not flow out of indoor unit.
- A pinging sound may be heard during defrosting operation, which, however does not mean that the air conditioner has failures.

■ Note on COOL operation

- This air conditioner cools the room by releasing the heat in the room outside. Therefore, the cooling performance of the air conditioner may be degraded if the outdoor temperature is high.

■ Note on DRY operation

- The computer chip works to rid the room of humidity while maintaining the temperature as much as possible. It automatically controls temperature and airflow rate, so manual adjustment of these functions is unavailable.

■ Notes on AUTO operation

- In AUTO operation, the system selects an appropriate operation mode (COOL or HEAT) based on the room and outside temperatures and starts the operation.
- The system automatically reselects setting at a regular interval to bring the room temperature to user-setting level.

■ Note on FAN operation

- This mode is valid for fan only.

■ Note on airflow rate setting

- At smaller airflow rates, the cooling (heating) effect is also smaller.

Adjusting the Airflow Direction

You can adjust the airflow direction to increase your comfort.

■ To start auto swing

Upper and lower airflow direction

Press .

- “” is displayed on the LCD.
- The flap (horizontal blade) will begin to swing.

■ To set the flap at desired position

- This function is effective while flap is in auto swing mode.

Press  when the flap has reached the desired position.

- The flap will stop moving.
- “” disappears from the LCD.



Adjusting the Airflow Direction

■ To adjust the louvers (vertical blades)

Hold the knob and move the louvers. (You will find a knob on the left-side and the right-side blades.)

- When the unit is installed in the corner of a room, the direction of the louvers should be facing away from the wall.
If they face the wall, the wall will block off the wind, causing the cooling (or heating) efficiency to drop.

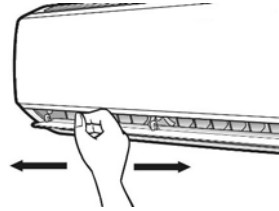

⚠ CAUTION

- Always use a remote controller to adjust the angles of the flap. If you attempt to move the flap and louvers forcibly with hand when they are swinging, the mechanism may be broken.
- Be careful when adjusting the louvers. Inside the air outlet, a fan is rotating at a high speed.

NOTE

■ Notes on the angles of the flap

- The flap swinging range depends on the operation. (See the figure.)
- If the air conditioner is operated in COOL or DRY operation with the flap kept stopped in the downward direction, the flap will automatically start operating in approximately an hour in order to prevent dew condensation.

In DRY operation or COOL operation

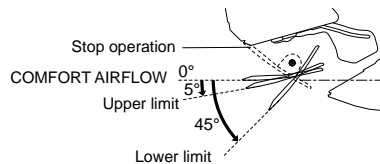

In HEAT operation

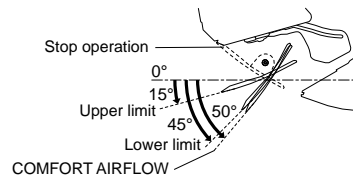

In FAN operation

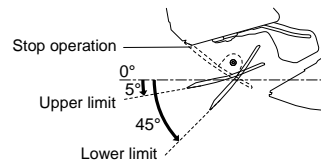

COMFORT AIRFLOW Operation

The flow of air will be in the upward direction while in COOL operation and in the downward direction while in HEAT operation, which will provide a comfortable wind that will not come in direct contact with people.

■ To start COMFORT AIRFLOW operation

1. Press  .

- The flap position will change, preventing air from blowing directly on the occupants of the room.
 - “” is displayed on the LCD.
 - Airflow rate is set to Auto.
- COOL/DRY: The flap will go up.
HEAT: The flap will go down.

■ To cancel COMFORT AIRFLOW operation

2. Press  again.

- The flap will return to the memory position from before COMFORT AIRFLOW mode.
- “” disappears from the LCD.

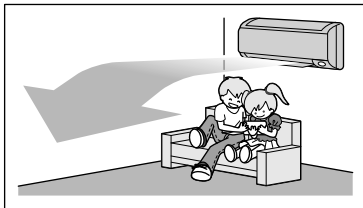

COOL operation

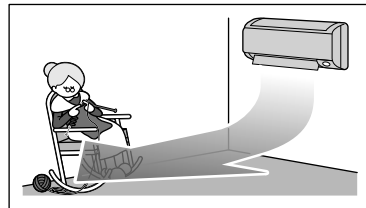

HEAT operation

NOTE

■ Notes on COMFORT AIRFLOW operation

- The flap position will change, preventing air from blowing directly on the occupants of the room.
- POWERFUL operation and COMFORT AIRFLOW operation cannot be used at the same time.
Priority is given to the function of whichever button is pressed last.
- The airflow rate will be set to Auto. If the upper and lower airflow direction is selected, the COMFORT AIRFLOW operation will be canceled.

POWERFUL Operation

POWERFUL operation quickly maximises the cooling (heating) effect in any operation mode. You can get the maximum capacity.

■ To start POWERFUL operation

1. Press



- POWERFUL operation ends in 20 minutes. Then the system automatically operates again with the previous settings which were used before POWERFUL operation.
- “” is displayed on the LCD.

■ To cancel POWERFUL operation

2. Press



again.

- “” disappears from the LCD.



NOTE

■ Notes on POWERFUL operation

- When using POWERFUL operation, there are some functions which are not available.
- POWERFUL operation cannot be used together with ECONO or COMFORT AIRFLOW operation.
Priority is given to the function of whichever button is pressed last.
- POWERFUL operation can only be set when the unit is running.
- POWERFUL operation will not increase the capacity of the air conditioner if the air conditioner is already in operation with its maximum capacity demonstrated.
- **In COOL, HEAT and AUTO operation**

To maximise the cooling (heating) effect, the capacity of outdoor unit is increased and the airflow rate is fixed to the maximum setting.

The temperature and airflow settings are not variable.

- **In DRY operation**

The temperature setting is lowered by 2.5°C and the airflow rate is slightly increased.

- **In FAN operation**

The airflow rate is fixed to the maximum setting.

ECONO Operation

ECONO operation is a function which enables efficient operation by limiting the maximum power consumption value.

This function is useful for cases in which attention should be paid to ensure a circuit breaker will not trip when the product runs alongside other appliances.



■ To start ECONO operation

1. Press  .
 - “” is displayed on the LCD.

■ To cancel ECONO operation

2. Press  again.
 - “” disappears from the LCD.

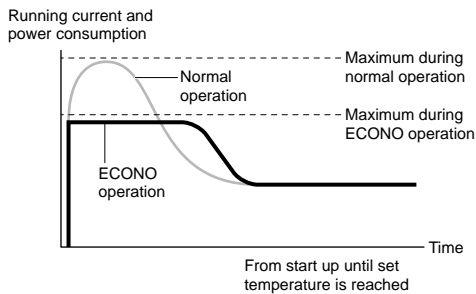

- This diagram is a representation for illustrative purposes only.
- * The maximum running current and power consumption of the air conditioner in ECONO operation vary with the connecting outdoor unit.

NOTE

■ Notes on ECONO operation

- ECONO operation can only be set when the unit is running.
- ECONO operation is a function which enables efficient operation by limiting the power consumption of the outdoor unit (operating frequency).
- ECONO operation functions in AUTO, COOL, DRY and HEAT operation.
- POWERFUL and ECONO operation cannot be used at the same time. Priority is given to the function of whichever button is pressed last.
- If the level of power consumption is already low, ECONO operation will not drop the power consumption.

OFF TIMER Operation

Timer functions are useful for automatically switching the air conditioner on or off at night or in the morning. You can also use OFF TIMER and ON TIMER in combination.

■ To use OFF TIMER operation

1. Press **OFF** .

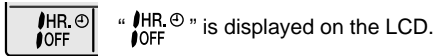

Each pressing of **OFF** advances the time setting by 1 hour.

The time can be set between 1 to 9 hours.

- The TIMER lamp lights up.

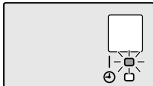

■ To cancel OFF TIMER operation

2. Press **CANCEL** .

- “HR. OFF” disappears from the LCD.
- The TIMER lamp goes off.



NOTE

■ Note on TIMER operation

- Once you set ON/OFF TIMER, the time setting is kept in the memory. The memory is canceled when remote controller batteries are replaced.

■ NIGHT SET mode

- When the OFF TIMER is set, the air conditioner automatically adjusts the temperature setting (0.5°C up in COOL, 2.0°C down in HEAT) to prevent excessive cooling (heating) for your pleasant sleep.

ON TIMER Operation

■ To use ON TIMER operation

1. Press **ON** .

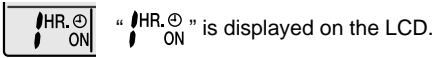

Each pressing of **ON** advances the time setting by 1 hour.
The time can be set between 1 to 12 hours.

- The TIMER lamp lights up.

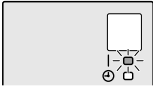

■ To cancel ON TIMER operation

2. Press **CANCEL** .

- "HR. ON" disappears from the LCD.
- The TIMER lamp goes off.



■ To combine ON TIMER and OFF TIMER

- A sample setting for combining the 2 timers is shown below.
- "ON" and "OFF" are displayed on the LCD.

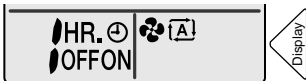

NOTE

■ In the following cases, set the timer again.

- After a breaker has turned off.
- After a power failure.
- After replacing batteries in the remote controller.

Care and Cleaning



CAUTION

Before cleaning, be sure to stop the operation and turn the breaker off.

Units

■ Indoor unit and remote controller

1. Wipe them with dry soft cloth.

■ Front panel

1. Open the front panel.

- Hold the front panel by the panel tabs on the both sides and open it.



2. Remove the front panel.

- Slide the front panel to either the left or right and pulling it toward you. This will disconnect the front panel shaft on one side.
- Disconnect the front panel shaft on the other side in the same manner.

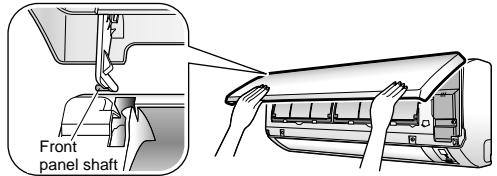

3. Clean the front panel.

- Wipe it with a soft cloth soaked in water.
- Only neutral detergent may be used.
- In case of washing the panel with water, wipe it with dry soft cloth, dry it up in the shade after washing.

4. Attach the front panel.

- Align the front panel shaft on the left and right of the front panel with the slots, then push them all the way in.
- Close the front panel slowly.
(Press the panel at both sides and the center.)

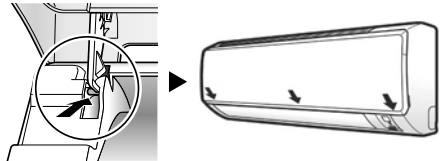

CAUTION

- Don't touch the metal parts of the indoor unit. If you touch those parts, this may cause an injury.
- When removing or attaching the front panel, use a robust and stable stool and watch your steps carefully.
- When removing or attaching the front panel, support the panel securely with hand to prevent it from falling.
- For cleaning, do not use hot water above 40°C, benzene, gasoline, thinner, nor other volatile oils, polishing compound, scrubbing brushes, nor other hand stuff.
- After cleaning, make sure that the front panel is securely fixed.

Care and Cleaning

Filters

1. Pull out the air filters.

- Open the front panel.
- Push a little upwards the tab at the center of each air filter, then pull it down.

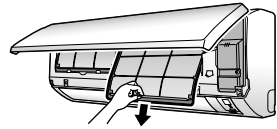

2. Take off the Titanium apatite deodorizing filter.

- Hold the recessed parts of the frame and unhook the 4 claws.

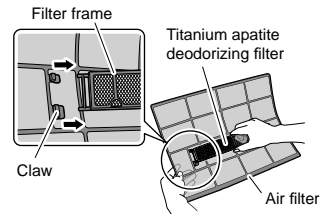

3. Clean or replace each filter.

3-1 Air filter

3-1-1 Wash the air filters with water or clean them with vacuum cleaner.

- If the dust does not come off easily, wash them with neutral detergent thinned with lukewarm water, then dry them up in the shade.
- Be sure to remove the Titanium apatite deodorizing filter.
- It is recommended to clean the air filters every 2 weeks.

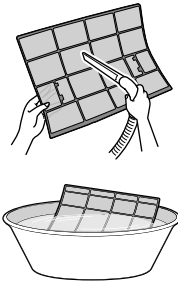

Care and Cleaning

3-2 Titanium apatite deodorizing filter

The Titanium apatite deodorizing filter can be renewed by washing it with water once every 6 months. We recommend replacing it once every 3 years.

[Maintenance]

3-2-1 Vacuum dusts, and soak in warm water or water for about 10 to 15 minutes if dirt is heavy.

- Do not remove the filter from frame when washing with water.

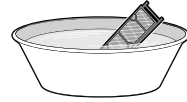

3-2-2 After washing, shake off remaining water and dry in the shade.

- Since the material is made out of polyester, do not wring out the filter when removing water from it.

[Replacement]

3-2-3 Remove the tabs on the filter frame and replace with a new filter.

- Do not throw away the filter frame. Reuse the filter frame when replacing the Titanium apatite deodorizing filter.
- Dispose of the old filter as non-flammable waste.

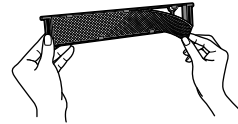

4. Set the air filter and Titanium apatite deodorizing filter as they were and close the front panel.

- Insert claws of the filters into slots of the front panel. Close the front panel slowly and push the panel at the 3 points. (One on each side and one in the middle.)

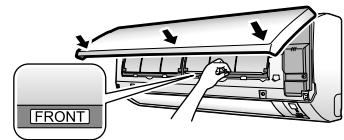

NOTE

- Operation with dirty filters:

- (1) cannot deodorise the air. (2) cannot clean the air.
- (3) results in poor heating or cooling. (4) may cause odour.

- To order Titanium apatite deodorizing filter contact to the service shop there you bought the air conditioner.

- Dispose of the old filter as non-flammable waste.



| Item | Part No. |
|---|-----------|
| Titanium apatite deodorizing filter (without frame) 1 set | KAF970A46 |

Care and Cleaning

Check

| |
|--|
| Check that the base, stand and other fittings of the outdoor unit are not decayed or corroded. |
| Check that nothing blocks the air inlets and the outlets of the indoor unit and the outdoor unit. |
| Check that the drain comes smoothly out of the drain hose during COOL or DRY operation. <ul style="list-style-type: none">• If no drain water is seen, water may be leaking from the indoor unit. Stop operation and consult the service shop if this is the case. |

■ Before a long idle period

1. Operate the FAN only for several hours on a fine day to dry out the inside.
 - Press  and select FAN operation.
 - Press  and start the operation.
2. After operation stops, turn off the breaker for the room air conditioner.
3. Clean the air filters and set them again.
4. Take out batteries from the remote controller.

We recommend periodical maintenance.

In certain operating conditions, the inside of the air conditioner may get foul after several seasons of use, resulting in poor performance. It is recommended to have periodical maintenance by a specialist aside from regular cleaning by the user. For specialist maintenance, contact the service shop where you bought the air conditioner.

The maintenance cost must be born by the user.

Important information regarding the refrigerant used

This product contains fluorinated greenhouse gases. Do not vent gases into the atmosphere.

Refrigerant type: **R410A**

GWP ⁽¹⁾ value: **2087.5**

⁽¹⁾ GWP = global warming potential

Periodical inspections for refrigerant leaks may be required depending on European or local legislation. Please contact your local dealer for more information.



NOTICE regarding tCO₂eq

In Europe, the **greenhouse gas emissions** of the total refrigerant charge in the system (expressed as tonnes CO₂-equivalent) is used to determine the maintenance intervals. Follow the applicable legislation.

Formula to calculate the greenhouse gas emissions:

GWP value of the refrigerant × Total refrigerant charge [in kg] / 1000

Troubleshooting

Troubleshooting measures are classified into the following two types on a remedial basis. Take an appropriate measure according to the symptom.



Not trouble

- These cases are not troubles. You may just continue using it.



Check

- Please check again before calling a repair person.

The flap does not start swing immediately.

- The air conditioner is adjusting the flap position. The flap will start moving soon.



The HEAT operation stops suddenly and a flowing sound is heard.

- The outdoor unit is taking away the frost. The HEAT operation starts after the frost on the outdoor unit is removed. You should wait for about 4 to 12 minutes.



Operation does not start soon.

- **When “ON/OFF” button was pressed soon after operation was stopped.**
- **When the mode was reselected.**
- This is to protect the air conditioner. You should wait for about 3 minutes.



A sound is heard.

■ A sound like a flow of water

- This sound is generated because the refrigerant in the air conditioner is flowing.
- This is a pumping sound of the water in the air conditioner it is heard when the water is pumped out from the air conditioner in cooling or drying operation.
- The refrigerant flows in the air conditioner even if the air conditioner is not working when the indoor units in other rooms are in operation.

■ Blowing sound

- This sound is generated when the flow of the refrigerant in the air conditioner is switched over.

■ Pinging sound

- This sound is generated when the size of the air conditioner slightly expands or shrinks as a result of temperature changes.

■ Clicking sound during operation or idle time

- This sound is generated when the refrigerant control valves or the electrical parts operate.

■ Clipping sound

- This sound is heard from the inside of the air conditioner when the exhaust fan is activated while the room doors are closed. Open the window or turn off the exhaust fan.



Troubleshooting

The outdoor unit emits water or steam.

■ In HEAT operation

- The frost on the outdoor unit melts into water or steam when the air conditioner is in defrost operation.

■ In COOL or DRY operation

- Moisture in the air condenses into water on the cool surface of outdoor unit piping and drips.



Operation stopped suddenly. (OPERATION lamp flashes.)

- Are the air filters clean?
Clean the air filters.
- Is there anything to block the air inlet or the outlet of the indoor and the outdoor units?
- Turn the breaker off and take all obstacles away. Then turn it on again and try operating the air conditioner with the remote controller. If the lamp still flashes, call the service shop where you bought the air conditioner.



The air conditioner does not operate. (OPERATION lamp is off.)

- Hasn't a breaker turned off or a fuse blown?
- Isn't it a power failure?
- Are batteries set in the remote controller?
- Is the timer setting correct?



Operation stopped suddenly. (OPERATION lamp is on.)

- For system protection, the air conditioner may stop operating on a sudden large voltage fluctuation. It automatically resumes operation in about 3 minutes.



Hot air does not flow out soon after the start of HEAT operation.

- The air conditioner is warming up. You should wait for 1 to 4 minutes. (The system is designed to start discharging air only after it has reached a certain temperature.)



Mist comes out of the indoor unit.

- This happens when the air in the room is cooled into mist by the cold airflow during COOL operation.
- This is because the air in the room is cooled by the heat exchanger and becomes mist during defrosting operation.



Troubleshooting

Cooling (Heating) effect is poor.

- Are the air filters clean?
- Is there anything to block the air inlet or the outlet of the indoor and the outdoor units?
- Is the temperature setting appropriate?
- Are the windows and doors closed?
- Are the airflow rate and the airflow direction set appropriately?



Remote controller does not work properly.

- **No remote controller signals are displayed.**
- **The remote controller sensitivity is low.**
- **The display is low in contrast or blacked out.**
- **The display runs out of control.**
 - The batteries are dying and the remote controller is malfunctioning. Replace all the batteries with new, size AAA.LR03 (alkaline). For details, refer to set the batteries of this manual. (page 7)



The indoor unit gives out odour.

- This happens when smells of the room, furniture, or cigarettes are absorbed into the unit and discharged with the airflow. (If this happens, we recommend you to have the indoor unit washed by a technician. Consult the service shop where you bought the air conditioner.)



The outdoor fan rotates while the air conditioner is not in operation.

- **After operation is stopped**
 - The outdoor fan continues rotating for another 60 seconds for system protection.
- **While the air conditioner is not in operation**
 - When the outdoor temperature is very high, the outdoor fan starts rotating for system protection.



An abnormal functioning happens during operation.

- The air conditioner may malfunction with lightning or radio waves. Turn the breaker off, turn it on again and try operating the air conditioner with the remote controller.



Troubleshooting

Call the service shop immediately.



WARNING

- When an abnormality (such as a burning smell) occurs, stop operation and turn the breaker off. Continued operation in an abnormal condition may result in troubles, electric shocks or fire. Consult the service shop where you bought the air conditioner.
- Do not attempt to repair or modify the air conditioner by yourself. Incorrect work may result in electric shocks or fire. Consult the service shop where you bought the air conditioner.

If one of the following symptoms takes place, call the service shop immediately.

- **The power cord is abnormally hot or damaged.**
- **An abnormal sound is heard during operation.**
- **The safety breaker, a fuse, or the earth leakage breaker cuts off the operation frequently.**
- **A switch or a button often fails to work properly.**
- **There is a burning smell.**
- **Water leaks from the indoor unit.**



Turn the breaker off and call the service shop.

- After a power failure
The air conditioner automatically resumes operation in about 3 minutes. You should just wait for a while.

- Lightning
If lightning may strike the neighbouring area, stop operation and turn the breaker off for system protection.

Disposal requirements

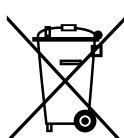

Your product and the batteries supplied with the controller are marked with this symbol. This symbol means that electrical and electronic products and batteries shall not be mixed with unsorted household waste.

For batteries, a chemical symbol can be printed beneath the symbol. This chemical symbol means that the battery contains a heavy metal above a certain concentration. Possible chemical symbols are:

- Pb: lead (>0.004%)

Do not try to dismantle the system yourself: the dismantling of the product, treatment of the refrigerant, of oil and of other parts must be done by a qualified installer in accordance with relevant local and national legislation.

Units and waste batteries must be treated at a specialised treatment facility for re-use, recycling and recovery.

By ensuring correct disposal, you will help to prevent potential negative consequences for the environment and human health.

Please contact the installer or local authority for more information.

Troubleshooting

Fault diagnosis.

Fault diagnosis by remote controller

The remote controller can receive a corresponding error code from the indoor unit.

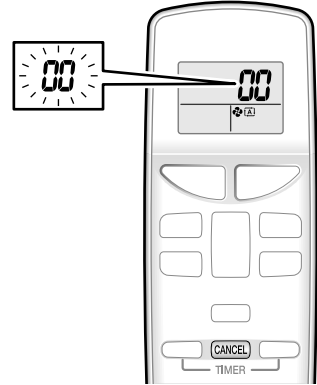

1. When **CANCEL** is held down for 5 seconds, a “00” indication blinks on the temperature display section.
2. Press **CANCEL** repeatedly until a continuous beep is produced.
 - The code indication changes as shown below, and notifies with a long beep.

| | CODE | MEANING |
|--------------|------|--|
| SYSTEM | 00 | NORMAL |
| | UA | INDOOR-OUTDOOR UNIT COMBINATION FAULT |
| | U0 | REFRIGERANT SHORTAGE |
| | U2 | DROP VOLTAGE OR MAIN CIRCUIT OVERVOLTAGE |
| | U4 | FAILURE OF TRANSMISSION (BETWEEN INDOOR UNIT AND OUTDOOR UNIT) |
| INDOOR UNIT | A1 | INDOOR PCB DEFECTIVENESS |
| | A5 | HIGH PRESSURE CONTROL OR FREEZE-UP PROTECTOR |
| | A6 | FAN MOTOR FAULT |
| | C4 | FAULTY HEAT EXCHANGER TEMPERATURE SENSOR |
| | C9 | FAULTY SUCTION AIR TEMPERATURE SENSOR |
| OUTDOOR UNIT | EA | COOLING-HEATING SWITCHING ERROR |
| | E1 | CIRCUIT BOARD FAULT |
| | E5 | OL STARTED |
| | E6 | FAULTY COMPRESSOR START UP |
| | E7 | DC FAN MOTOR FAULT |
| | E8 | OVERCURRENT INPUT |
| | F3 | HIGH TEMPERATURE DISCHARGE PIPE CONTROL |
| | F6 | HIGH PRESSURE CONTROL (IN COOLING) |
| | H0 | SENSOR FAULT |
| | H6 | OPERATION HALT DUE TO FAULTY POSITION DETECTION SENSOR |
| | H8 | DC CURRENT SENSOR FAULT |
| | H9 | FAULTY SUCTION AIR TEMPERATURE SENSOR |
| | J3 | FAULTY DISCHARGE PIPE TEMPERATURE SENSOR |
| | J6 | FAULTY HEAT EXCHANGER TEMPERATURE SENSOR |
| | L3 | ELECTRICAL PARTS HEAT FAULT |
| | L4 | HIGH TEMPERATURE AT INVERTER CIRCUIT HEATSINK |
| | L5 | OUTPUT OVERCURRENT |
| | P4 | FAULTY INVERTER CIRCUIT HEATSINK TEMPERATURE SENSOR |

NOTE

- A short beep and 2 consecutive beeps indicate non-corresponding codes.
- To cancel the code display, hold the **CANCEL** down for 5 seconds. The code display also cancel itself if the button is not pressed for 1 minute.





DAIKIN INDUSTRIES CZECH REPUBLIC s.r.o.

U Nové Hospody 1/1155, 301 00 Plzeň Skvrňany, Czech Republic

DAIKIN EUROPE N.V.

Zandvoordestraat 300, B-8400 Oostende, Belgium

Copyright 2014 Daikin



3P341266-4L 2017.08