

DAIKIN



OPERATION MANUAL

Packaged air-cooled water chillers

EWAP110MBYNN
EWAP140MBYNN
EWAP160MBYNN
EWAP200MBYNN
EWAP280MBYNN
EWAP340MBYNN

CONTENTS

	Page
Introduction	1
Technical specifications	1
Electrical specifications	1
Important information regarding the refrigerant used	2
Description	2
Function of the main components.....	3
Safety devices.....	3
Internal wiring - Parts table.....	4
Before operation.....	5
Checks before initial start-up.....	5
Water supply.....	5
Power supply connection and crankcase heating.....	5
General recommendations.....	6
Operation	6
Digital controller.....	6
Working with the unit.....	6
Advanced features of the digital controller.....	9
Troubleshooting.....	15
Maintenance.....	17
Maintenance activities.....	17
Disposal requirements.....	17



READ THIS MANUAL ATTENTIVELY BEFORE STARTING UP THE UNIT. DO NOT THROW IT AWAY. KEEP IT IN YOUR FILES FOR FUTURE REFERENCE.

INTRODUCTION

This operation manual concerns packaged air-cooled water chillers of the Daikin EWAP-MBYNN series. These units are provided for outdoor installation and used for cooling applications. The EWAP units can be combined with Daikin fan coil units or air handling units for air conditioning purposes. They can also be used for supplying water for process cooling.

This manual has been prepared to ensure adequate operation and maintenance of the unit. It will tell you how to use the unit properly and will provide help if problems occur. The unit is equipped with safety devices, but they will not necessarily prevent all problems caused by improper operation or inadequate maintenance.

In case of persisting problems contact your local Daikin Dealer.



Before starting up the unit for the first time, make sure that it has been properly installed. It is therefore necessary to carefully read the installation manual supplied with the unit and the recommendations listed in "Checks before initial start-up" on page 5.

Technical specifications⁽¹⁾

General EWAP		110	140	160
Dimensions HxWxD (mm)		2250x2346x2238		
Weight				
• machine weight (kg)		1411	1565	1654
• operation weight (kg)		1419	1578	1670
Connections				
• chilled water inlet and outlet		3" OD (76 mm OD)		
• evaporator drain		—		

Compressor		110	140	160
Type		semi-hermetic single screw		
Qty x model		1x ZHC3LTGUYE	1x ZHC3WLGUYE	1x ZHC5LMGUYE
Speed (rpm)		2880		
Oil type		FVC 68D		
Oil charge volume (l)		5.5	5.5	7.5
Condensor				
Nominal air flow (m ³ /min)		960		
No. of motors x output (W)		4 x 550	4 x 1020	4 x 1020
Evaporator				
Model		1x AC120EQ-NP80	1x AC120EQ-NP120	1x AC120EQ-NP156

General EWAP		200	280	340
Dimensions HxWxD (mm)		2250x4280x2238		
Weight				
• machine weight (kg)		2193	2573	2623
• operation weight (kg)		2213	2600	2657
Connections				
• chilled water inlet and outlet		3" (88.9 mm OD)		
• evaporator drain		1/4"G		

Compressor		200	280	340
Type		semi-hermetic single screw		
Qty x model		1x ZHC5WLGUYE	1x ZHC7LSGUYE	1x ZHC7WSGUYE
Speed (rpm)		2880		
Oil type		FVC 68D		
Oil charge volume (l)		7.5	10	10
Condensor				
Nominal air flow (m ³ /min)		1920		
No. of motors x output (W)		8x 550	8x 1020	8x 1020
Evaporator				
Model		1x AC250EQ-NP96	1x AC250EQ-NP128	1x AC250EQ-NP162

Electrical specifications⁽¹⁾

Model EWAP		110	140	160	200	280	340
Power supply							
• Phase		3~					
• Frequency (Hz)		50					
• Voltage (V)		400					
• Voltage tolerance (%)		±10					
Unit							
• Nominal running current (A)		70	84	104	128	180	226
• Maximum running current (A)		95	120	135	168	232	288
• Recommended fuses according to IEC 269-2 (gL)		3x 125	3x 160	3x 160	3x 200	3x 250	3x 355
Compressor							
• Phase		3~					
• Frequency (Hz)		50					
• Voltage (V)		400					
• Nominal running current (A)		62	70	90	112	155	201
Control and fan motor							
• Phase		3~					
• Frequency (Hz)		50					
• Voltage (V)		400					
• Nominal running current (A)		4x 1.9	4x 3.1	4x 3.1	8x 1.9	8x 3.1	8x 3.1

(1) Refer to the engineering data book for the complete list of specifications.

Important information regarding the refrigerant used

This product contains fluorinated greenhouse gases covered by the Kyoto Protocol.

Refrigerant type: R407C

GWP⁽¹⁾ value: 1652.5

⁽¹⁾ GWP = global warming potential

Periodical inspections for refrigerant leaks may be required depending on European or local legislation. Please contact your local dealer for more information.

DESCRIPTION

The EWAP air-cooled water chillers are available in 6 standard sizes.

EWAP110~160

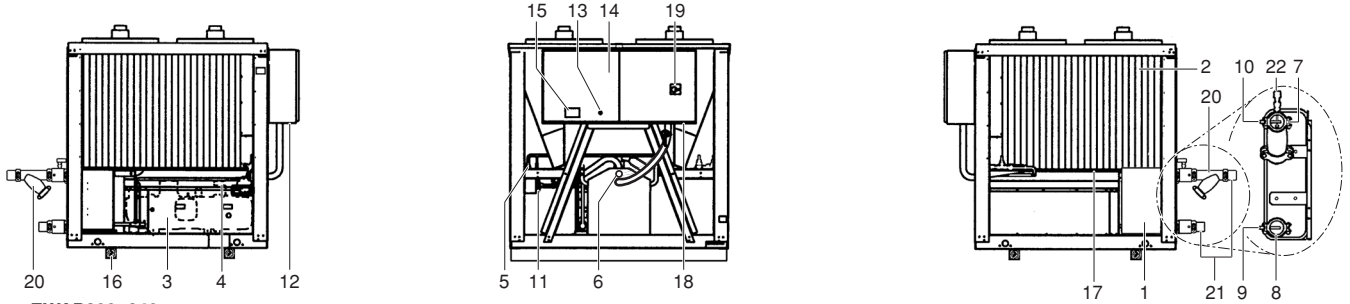

EWAP200~340

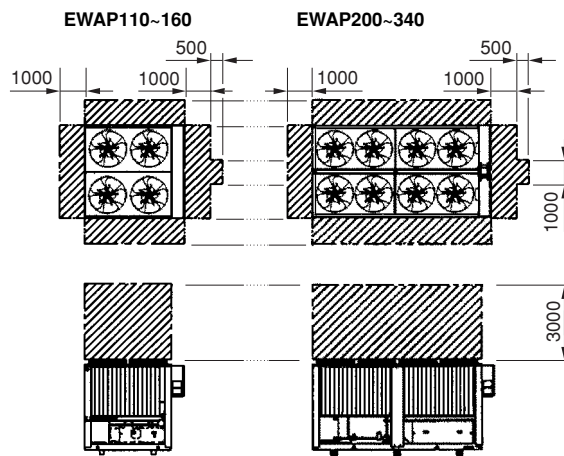
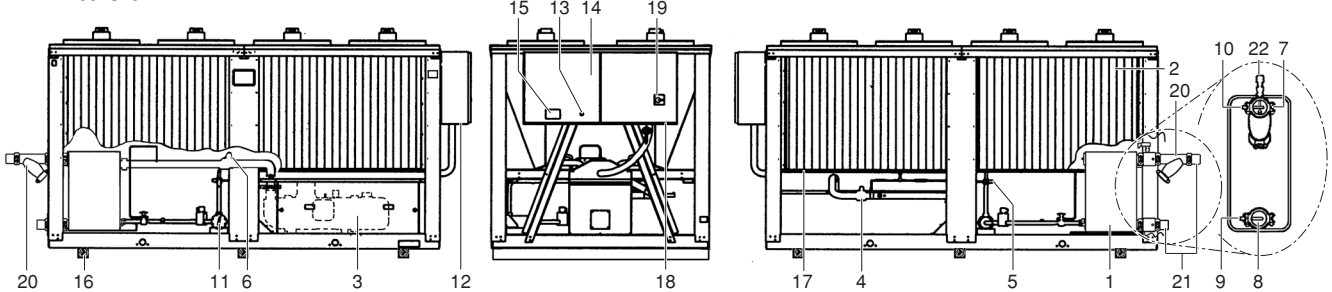



Figure - Main components

- | | | | |
|----|---|----|--|
| 1 | Evaporator | 12 | Power supply intake |
| 2 | Condenser | 13 | Emergency stop (S5E) |
| 3 | Compressor (M1C) | 14 | Switchbox |
| 4 | Discharge stop valve | 15 | Digital display controller |
| 5 | Liquid stop valve | 16 | Transportbeam |
| 6 | Suction stop valve (optional) | 17 | Ambient temperature sensor (R5T) |
| 7 | Chilled water in (Victaulic® coupling) | 18 | Field wiring intake |
| 8 | Chilled water out (Victaulic® coupling) | 19 | Main isolator switch (optional - S13S) |
| 9 | Leaving water temperature sensor (R4T) | 20 | Filter |
| 10 | Entering water temperature sensor (R3T) | 21 | Counterpipe |
| 11 | Drier + charge valve | 22 | Flowswitch |

 Required space around the unit for service and air intake

 Refer to "Preparing, checking and connecting the water circuit" in the installation manual for more details

Function of the main components

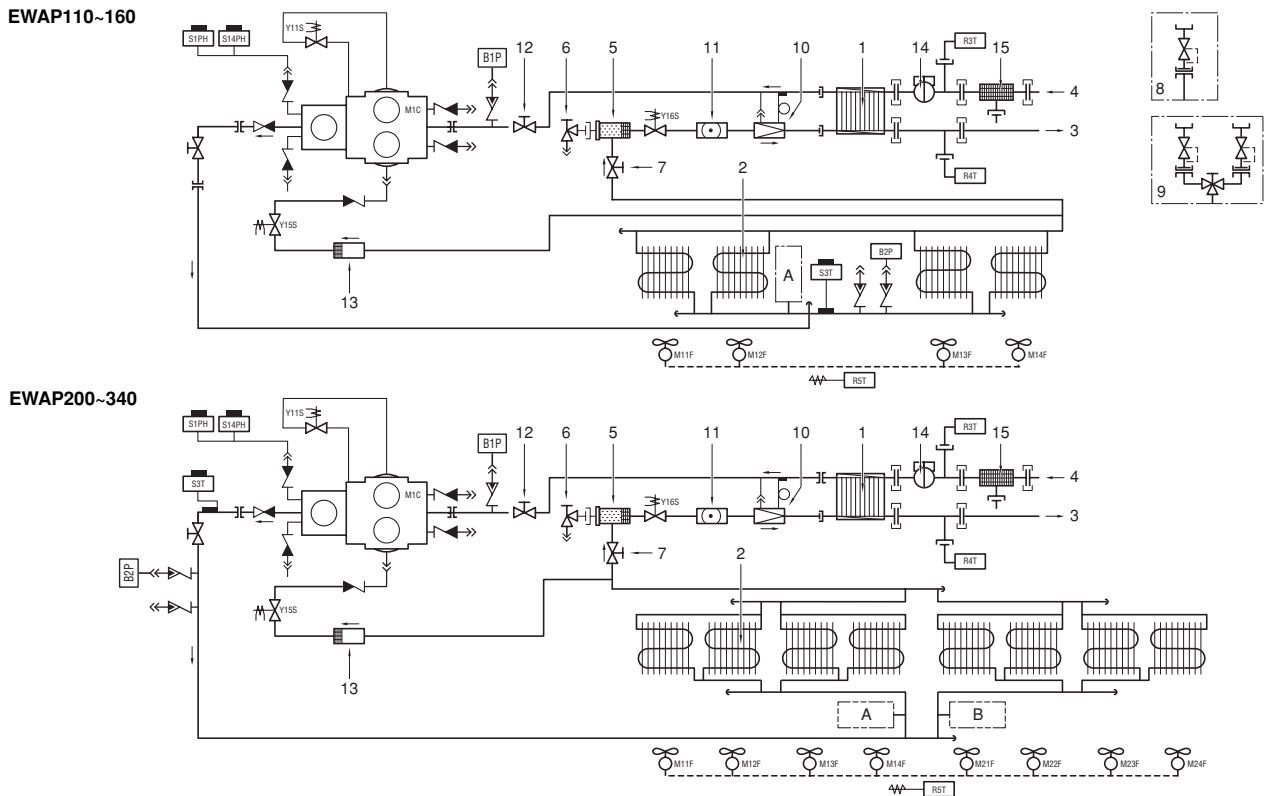

Figure - Functional diagram

- | | | | |
|---|--|----|--|
| 1 | Evaporator | 10 | Expansion valve |
| 2 | Condenser | 11 | Sightglass |
| 3 | Water outlet | 12 | Suction stop valve (optional) |
| 4 | Water inlet | 13 | Strainer |
| 5 | Drier | 14 | Flowswitch |
| 6 | Charge valve | 15 | Water filter |
| 7 | Liquid stop valve | A | Standard (see 8) or optional dual pressure relief valve (see 9) |
| 8 | Standard: safety valve | B | Only for EWAP280 or EWAP340: standard (see 8) or optional dual pressure relief valve (see 9) |
| 9 | Optional dual pressure relief valve: safety valves | | |

As the refrigerant circulates through the unit, changes in its state or condition occur. These changes are caused by the following main components:

- **Compressor**
The compressor (M^{*C}) acts as a pump and circulates the refrigerant in the refrigeration circuit. It compresses the refrigerant vapour coming from the evaporator at the pressure at which it can easily be liquefied in the condenser.
- **Condenser**
The function of the condenser is to change the state of the refrigerant from gaseous to liquid. The heat gained by the gas in the evaporator is discharged through the condenser to the ambient air, and the vapour condenses to liquid.
- **Filter/drier**
The filter installed behind the condenser removes small particles from the refrigerant to prevent blockage of the tubes. The drier takes water out of the system.
- **Expansion valve**
The liquid refrigerant coming from the condenser enters the evaporator via an expansion valve. The expansion valve brings the liquid refrigerant to a pressure at which it can easily be evaporated in the evaporator.

- **Evaporator**
The main function of the evaporator is to take heat from the water that flows through it. This is done by turning the liquid refrigerant, coming from the condenser, into gaseous refrigerant.
- **Water in/outlet connection**
The water inlet and outlet connection allow an easy connection of the unit to the water circuit of the air handling unit or industrial equipment.
- **Flowswitch**
The flowswitch protects the evaporator of the unit against freezing when there is no waterflow or when the waterflow is too low.
- **Water filter**
The water filter protects the evaporator against clogging.

Safety devices

The unit is equipped with three kinds of safety devices:

- 1 **General safety devices**
General safety devices shut down all circuits and stop the whole unit. For this reason the unit has to be manually put on again after a general safety occurred.

2 Circuit safety devices

Circuit safety devices shut down the circuit they protect. For this reason the unit does not need to be manually put on again after a circuit safety occurred.

3 Part safety devices

Part safety devices shut down the part they protect.

An overview of all safety devices is given below.

■ Overcurrent relay

The overcurrent relays (K*S) are located in the switchbox of the unit and protect the compressor motors in case of overload, phase failure or too low voltage. The relays are factory-set and may not be adjusted. When activated, they must be reset manually, followed by a reset of the controller.

■ Compressor thermal protectors

The compressor motors are equipped with thermal protectors (Q*M). The protectors are activated when the compressor motor temperature becomes too high.

When temperature returns to normal, the protectors reset automatically, but the controller needs to be reset manually.

■ Fan motor thermal protector

The condenser fan motors are equipped with thermal protectors (Q*F). The protectors are activated when the temperature becomes too high. When temperature returns to normal, the protectors reset automatically.

■ Flowswitch

The unit is protected by a flowswitch (S8L).

When the waterflow becomes lower than the minimum allowed waterflow, the flowswitch shuts down the unit. When the waterflow becomes normal, the protection resets automatically but the controller still needs to be reset manually.

■ Discharge thermal protectors

The unit is equipped with discharge thermal protectors (S*T). The protectors are activated when the temperature of the refrigerant leaving the compressor becomes too high. When the temperature returns to normal the protector resets automatically and the controller needs to be reset manually.

■ Freeze-up protection

The freeze-up protection prevents the water in the evaporator from freezing during operation. When the outlet water temperature is too low, the controller disables the unit. When the outlet water temperature returns to normal, the unit can start up again.

When freeze-up protection occurs several times in a certain period, the freeze-up alarm will be activated and the unit will be shut down. The cause of freezing up should be investigated and after outlet water temperature has risen enough, the alarm indicator on the controller needs to be reset manually.

■ Low pressure safety

When the suction pressure of a circuit is too low, the circuit controller shuts down the circuit. When the pressure returns to normal, the safety device can be reset on the controller.

■ Pressure relief safety valve

The safety valve is activated when the pressure in the refrigerant circuit becomes too high. If this occurs, shut down the unit and contact your local dealer.

■ High pressure switch

Each circuit is protected by two high pressure switches (S*PH) which measure the condenser pressure (pressure at the outlet of the compressor). They are installed in the compressor housing of the circuit. When the pressure becomes too high, the pressure switches are activated and the circuit stops.

The switches are factory-set and may not be adjusted. When activated, they must be reset by means of a screwdriver. The controller still needs to be reset.

■ Reverse phase protector

The reverse phase protectors (R*P) prevent the screw compressors from running in the wrong direction. If the compressors do not start, two phases of the power supply must be inverted.

Internal wiring - Parts table

Refer to the internal wiring diagram supplied with the unit. The abbreviations used are listed below:

A1.....	**	Current transfo/A-meter
A1P		PCB controller
B1P		Low pressure transmitter
B2P		High pressure transmitter
C1~C3.....		Capacitor
E1HC		Crankcase heater compressor
E3H		Evaporator heater
F1U~F3U ... #.....		Main fuses
F4U,F5U #.....		Fuses for evaporator heater
F6B		Fuse for primary of TR1
F7B		Fuse for secondary of TR1
F8U		Surge proof fuse for A1P
F9B		Fuse for secondary of TR2
F12B,F14B.....		Fuse for fanmotors
H1P	*	Indication lamp general operation
H2P	*	Indication lamp alarm
H3P	*	Indication lamp operation compressor
H5P	*	Changeable output
J1		Power supply
J2,J3,J6.....		Analog input
J5,J7,J8.....		Digital input
J11		RS485 connection
J12~J18		Digital output
K1M.....		Linecontactor
K2M.....		Deltacontactor
K3M.....		Starcontactor
K7F~K9F.....		Fancontactor
K17S		Overcurrent relay
K1A		Auxiliary relay for safeties
K2A		Auxiliary relay compressor thermal protector
K3A		Auxiliary relay for discharge thermal protector
K7A		Auxiliary relay for safety of high pressure
L1~L3.....		Main supply terminals
M11F-M18F		Fan motors
M1C		Compressor motor
M1S.....		Stepless capacity control for compressor
PE		Main earth terminal
Q11F-Q18F.....		Thermal protectors fan motors
Q1M		Thermal protector compressor motor
R1		Auxiliary resistance for feedback (R1F)
R1F		Feedback resistance
R1P		Reverse phase protector
R3T		Sensor for evaporator inlet water temperature
R4T		Sensor for outlet water temperature
R5T		Sensor for ambient temperature
R8T		Sensor for evaporator outlet water temperature in a DICN system
S1PH.....		High pressure switch
S3T		Discharge thermal protector
S5E		Emergency stop push button
S6S	*	Changeable switch for remote function (e.g. remote start/stop)

S8L.....	Flowswitch
S9L..... #.....	Contact that closes if the pump is working
S10S..... *.....	Changeable switch for remote function (e.g. dual setpoint)
S11S..... *.....	Changeable switch for remote function (e.g. enable/disable capacity limitation 1)
S12S..... *.....	Changeable switch for remote function (e.g. enable/disable capacity limitation 2)
S13S..... ##.....	Main isolator switch
S14PH.....	High pressure switch
TC01,TC02.....	Optocoupler (analog to digital signal)
TR1.....	Transfo for control circuit
TR2.....	Transfo for supply controller + digital inputs
V1..... **.....	V-meter
Y11S.....	12% capacity step for compressor
Y15S.....	Liquid injection valve of the compressor
Y16S.....	Liquid line solenoid valve

	Not included with standard unit	
	Not possible as option	Possible as option
Obligatory	#	##
Not obligatory	*	**

BEFORE OPERATION

Checks before initial start-up



Make sure that the circuit breaker on the power supply panel of the unit is switched off.

After the installation of the unit, check the following before switching on the circuit breaker:

- Field wiring**
Make sure that the field wiring between the local supply panel and the unit has been carried out according to the instructions described in the installation manual, according to the wiring diagrams and according to European and national regulations.
- Additional pump interlock contact**
Additional pump interlock contact (S9L) must be provided. Make sure that the contact has been installed between the appropriate terminals (refer to the wiring diagram supplied with the unit). The contact must be a normal open contact.
- Fuses or protection devices**
Check that the fuses or the locally installed protection devices are of the size and type specified in the installation manual. Make sure that neither a fuse nor a protection device has been bypassed.
- Earth wiring**
Make sure that the earth wires have been connected properly and that the earth terminals are tightened.
- Internal wiring**
Visually check the switch box on loose connections or damaged electrical components.
- Fixation**
Check that the unit is properly fixed, to avoid abnormal noises and vibrations when starting up the unit.
- Damaged equipment**
Check the inside of the unit on damaged components or squeezed pipes.

- Refrigerant leak**
Check the inside of the unit on refrigerant leakage. If there is a refrigerant leak, call your local dealer.
- Oil leak**
Check the compressor on oil leakage. If there is an oil leak, call your local dealer.
- Stop valves**
Open the liquid line, discharge and suction (if provided) stop valves completely.
- Air inlet/outlet**
Check that the air inlet and outlet of the unit is not obstructed by paper sheets, cardboard, or any other material.
- Power supply voltage**
Check the power supply voltage on the local supply panel. The voltage must correspond to the voltage on the identification label of the unit.
- Water connection**
Check water piping system and circulating pumps. Check if the filter kit that was supplied with the unit separately is installed correctly in front of the evaporator water inlet.
- Water sensors**
Check that all the water sensors are correctly fixed into the pipes connected to the evaporator.

Water supply

Fill the water piping, taking into account the minimum water volume required by the unit. Refer to the Installation manual.

Make sure that the water is of the quality as mentioned in the installation manual.

Purge the air at the high points of the system and check the operation of the circulation pump and the flowswitch.

Power supply connection and crankcase heating



In order to avoid compressor damage, it is necessary to switch on the crankcase heater for **at least 8 hours** before starting the compressor after a long period of standstill.

To switch on the crankcase heater proceed as follows:

- Switch on the circuit breaker on the local supply panel. Make sure that the unit is "OFF".
- The crankcase heater is switched on automatically.
- Check the supply voltage on the supply terminals L1, L2, L3, by means of a voltmeter. The voltage must correspond to the voltage indicated on the identification label of the unit. If the voltmeter reads values which are not within the ranges specified in the technical data, check the field wiring and replace the supply cables if necessary.
- Check the LED on the reverse phase protectors. If it lights up, the phase order is correct. If not, switch off the circuit breaker and call a licensed electrician to connect the wires of the power supply cable in the correct phase order.
- Check if the crankcase heaters are warming up.

After 8 hours, the unit is ready for operation.

General recommendations

Before switching on the unit, read following recommendations:

- 1 When the complete installation and all necessary settings have been carried out, close all front panels of the unit.
- 2 The service panels of the switch boxes may only be opened by a licensed electrician for maintenance purposes.
- 3 To prevent the evaporator from freezing and to avoid damage to the LCD displays of the digital controller, never switch off the power supply during winter.

OPERATION

The EWAP units are equipped with a digital controller offering a user-friendly way to set up, use and maintain the unit.

This part of the manual has a task-oriented, modular structure. Apart from the first section, which gives a brief description of the controller itself, each section or subsection deals with a specific task you can perform with the unit.

Digital controller

User interface

The digital controller consists of an alphanumeric display, labelled keys which you can press and a number of LEDs.

Digital built-in controller

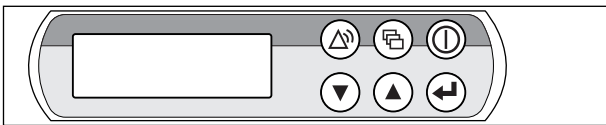

Figure - Digital built-in controller

- ⊞ key, to enter the main menu
- Ⓜ key, to start up or to shut down the unit.
- ⚠ key, to enter the safeties menu or to reset an alarm.
- ▲ keys, to scroll up or down through the screens of a menu (only in case ▲, ▼ or ⇄ appears) or to raise, respectively lower a setting.
- ⏪ key, to confirm a selection or a setting.

Digital remote controller (to be ordered separately)

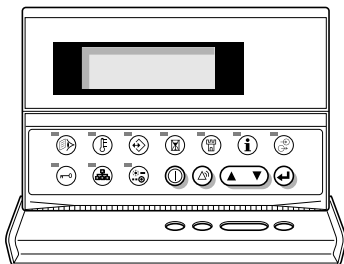

Figure - Digital remote controller

- Ⓜ key, to start up or to shut down the unit.
- ⚠ key, to enter the safeties menu or to reset an alarm.
- ▲▼ key, to scroll through the screens of a menu (only in case ▲, ▼ or ⇄ appears) or to raise, respectively lower a setting.
- ⏪ key, to confirm a selection or a setting.
- ⊞ key, to enter the readout menu.
- Ⓜ key, to enter the setpoints menu.

- ⊞ key, to enter the user settings menu.
- Ⓜ key, to enter the timers menu.
- Ⓜ key, to enter the history menu.
- ⓘ key, to enter the info menu.
- Ⓜ key, to enter the input/output status menu.
- ⏪ key, to enter the user password menu.
- Ⓜ key, to enter the DICN menu, also referred to as network menu.
- Ⓜ key, has no effect on EWAP units.

NOTE Temperature readout tolerance: $\pm 1^{\circ}\text{C}$.

Legibility of the alphanumeric display may decrease in direct sunlight.

How to enter a menu

- Digital built-in controller
Scroll through the main menu using the ▲ and ▼ keys to move the > mark in front of the menu of your choice. Push the ⊞ key to enter the selected menu.

```
>READOUT MENU
SETPOINTS MENU
USERSETTINGS MENU
TIMERS MENU
HISTORY MENU
INFO MENU
I/O STATUS MENU
USERPASSWORD MENU
NETWORK MENU
```

- Digital remote controller
Press the corresponding menu key indicated in "User interface", paragraph "Digital remote controller" on page 6

Connection of a remote digital controller to the unit

For a remote digital controller a cable length of up to 600 metres between the remote digital controller and the unit is allowed. This gives the opportunity to control the unit from a considerable distance. Refer to "Cable for remote digital controller" in the installation manual for cable specifications.

For units in a DICN configuration, the remote digital controllers of the units can be installed at a distance of up to 50 metres by using a 6-ray telephone cable with a maximum cable resistance of 0.1 Ω/m .

NOTE When a remote digital controller is connected to a stand-alone unit, the address of the remote digital controller has to be set to 2 by means of the DIP-switches on the back of the remote digital controller. Refer to the installation manual "Setting the addresses on the remote digital controller" for setting the address.

When a remote digital controller is connected to a unit that is part of a DICN network, the addresses have to be set according to the instructions in the installation manual.



Working with the unit

This chapter deals with the everyday usage of the unit. Here, you will find how to perform routine tasks, such as:



- "Setting the language" on page 7
- "Switching the unit on" on page 7
- "Consulting actual operational information" on page 7
- "Adjusting the temperature setpoint" on page 8
- "Resetting the unit" on page 8

Setting the language

If desired, the operating language can be changed to any of the following languages: English, German, French, Spanish or Italian.

- 1 Enter the usersettings menu. Refer to chapter "How to enter a menu" on page 6
- 2 Go to the appropriate screen of the usersettings menu using the  and  keys.
- 3 Press  to change the operating language until the desired language is active.

Switching the unit on



- 1 Press the  key on the controller.
Depending on whether or not a remote ON/OFF switch has been configured (refer to the installation manual), the following conditions may occur.
When no remote ON/OFF switch is configured, the LED inside the  key lights up and an initialization cycle is started. Once all the timers have reached zero, the unit starts up.
When a remote ON/OFF switch is configured, the following table applies:

Local key	Remote switch	Unit	 LED
ON	ON	ON	ON
ON	OFF	OFF	Flashing
OFF	ON	OFF	OFF
OFF	OFF	OFF	OFF



- 2 If the water chiller does not start after a few minutes, refer to "Troubleshooting" on page 15.

Switching the unit off

If no remote on/off switch is configured:

Press the  key on the controller.
The LED inside the  key goes out.

If a remote on/off switch is configured:

Press the  key on the controller or switch the unit off using the remote on/off switch.
The LED inside the  key goes out in the first case and starts blinking in the second case.



In case of emergency, switch off the unit by pushing the emergency stopbutton.

NOTE



Also consult "Defining the schedule timer" on page 11 and "Customization in the service menu" chapter "Setting of the changeable inputs and outputs" in the installation manual.

Switching units ON/OFF in a DICN system

If the  key is pressed on a unit with status NORMAL or STANDBY, all other units with status NORMAL or STANDBY will be ON or OFF.

If the  key is pressed on a unit with status DISCONNECT ON/OFF, only this unit will be ON or OFF.

NOTE



When a remote ON/OFF switch is configured, the remote ON/OFF contact for all units with status NORMAL or STANDBY of a DICN network is the contact connected to the master unit.

For units with status DISCONNECT ON/OFF, the remote contact is the contact connected to this unit.

NOTE



If the user wants 1 unit to operate on his command only, this unit is to be set to DISCONNECT ON/OFF.

It is recommended not to select the master unit for this purpose. Even if the status of the master is set to DISCONNECT ON/OFF, it will still be the contact connected to the master which will switch ON/OFF the other units in NORMAL or STANDBY mode. It would therefore never be possible to only switch the master unit OFF remotely.

Switching OFF the master unit only, should in this case be done by the local ON/OFF key on the master unit.

Consulting actual operational information

- 1 Enter the readout menu. Refer to the chapter "How to enter a menu" on page 6.

The controller automatically shows the first screen of the readout menu which provides the following information:

- MANUAL MODE or INLSETP1/2 or OUTLSETP1/2: manual/automatic control mode operation. If the automatic control mode is selected, the controller will indicate the active temperature setpoint. Depending on the status of the remote contact, setpoint one or setpoint two is active.
- INL WATER E: actual evaporator inlet water temperature.
- OUTL WATER E: actual evaporator outlet water temperature.

NOTE



For a DICN system, the INLET WATER, OUTLET WATER values are the values of the individual units, not of the system. Temperatures of the system can be consulted in the first screen of the network menu.

- 2 Press the  key to enter the next screen of the readout menu.
The UNIT STATUS screen of the readout menu provides information concerning the status of the different circuits.
 - C1: actual status of circuit.
When the circuit is ON, the following status information may appear.
 - C1: 40% - this percentage refers to the activated capacity of that specific circuit.

NOTE



When a circuit is in a high pressure setback, the indication of capacity will be flashing. A high pressure setback is a prevention of load-up or a forced load-down caused by a too high pressure.



When a circuit is OFF, the following status information may appear.

- SAFETY ACTIVE: one of the circuit safety devices is activated (refer to "Troubleshooting" on page 15).
- <LIMIT>: the circuit is limited by a remote contact.
- TIMERS BUSY: the actual value of one of the software timers is not zero (refer to "Timers menu" on page 9).
- CAN STARTUP: the circuit is ready to start up when extra cooling load is needed.

The preceding OFF messages are written down in order of priority. If one of the timers is busy and one of the safeties is active, the status information says SAFETY ACTIVE.

The UNIT CAPACITY is written down on the bottom of the screen. The percentage is the actual cooling capacity of the unit.

- 3 Press the  key to enter the next screen of the readout menu.
The ACTUAL PRESSURES screen of the readout menu provides information concerning the pressures of circuit.
 - HP1: high pressure of the refrigerant in circuit. The first number stands for the pressure in bar, the second number stands for the bubble point saturation temperature in degrees Celsius.
 - LP1: low pressure of the refrigerant in circuit. The first number stands for the pressure in bar, the second number stands for the dew point saturation temperature in degrees Celsius.

- 4 Press the  key to enter the next screen of the readout menu.
To consult actual operational information about the ambient temperature and the total running hours of the compressor.
- 5 Press the  key to return to the other readout menus.

Adjusting the temperature setpoint

The unit provides definition and selection of four independent temperature setpoints. Two setpoints are reserved for inlet control, the other two are reserved for outlet control.

- INLSETP1E: inlet water temperature of evaporator, setpoint 1,
- INLSETP2E: inlet water temperature of evaporator, setpoint 2.
- OUTLSETP1E: outlet water temperature of evaporator, setpoint 1,
- OUTLSETP2E: outlet water temperature of evaporator, setpoint 2.







The selection between setpoint 1 and 2 is done by a remote dual setpoint switch (to be installed by the customer). The actual active setpoint can be consulted in the readout menu.

NOTE  The customer is also allowed to define a setpoint in function of an analog input.

NOTE  Refer to "Customization in the service menu" chapter "Setting of the changeable inputs and outputs" in the installation manual

If the manual control mode is selected (refer to "User settings menu" on page 9), none of the above-mentioned setpoints will be active.

To adjust a setpoint, proceed as follows:

- 1 Enter the setpoints menu. Refer to the chapter "How to enter a menu" on page 6.
If the user password is disabled for setpoint modifications (refer to "User settings menu" on page 9), the controller will immediately enter the setpoints menu.
If the user password is enabled for setpoint modifications, enter the correct code using the  and  keys (refer to "User password menu" on page 10). Press  to confirm the password and to enter the setpoints menu.
- 2 Select the setpoint to be adjusted using the  key.
A setpoint is selected when the cursor is blinking behind the setpoint's name.
The ">" sign indicates the actual active temperature setpoint.
- 3 Press the  and  keys to adjust the temperature setting.
The default, limit and step values for the cooling temperature setpoints are:

	SETP IN E	SETPOUT E
default value	12°C	7°C
limit values ^(a)	7 --> 23°C	4 --> 16°C
step value	0.1°C	0.1°C

(a) For glycol treated units, the lower limit of the cooling temperature setpoint can be adapted by changing the minimum operating temperature in the service menu (refer to the installation manual). The following values apply:

SETP IN E: 5°C, 3°C, -2°C, -7°C
SETPOUT E: 2°C, 0°C, -5°C, -10°C

- 4 Press  to save the adjusted temperature setpoint.
When the setting has been confirmed, the cursor switches to the next setpoint.
- 5 To adjust other setpoints, repeat from step 2.

NOTE  When a setpoint on a unit in a DICN system is set, this setpoint will be transferred to all other units.



NOTE  Also consult "Defining the schedule timer" on page 11 and "Defining the floating setpoint settings" on page 12.

Resetting the unit

The units are equipped with three kinds of safety devices: unit safeties, circuit safeties and network safeties.







When a unit or circuit safety occurs, the compressor is shut down. The safeties menu will indicate which safety is activated. The UNIT STATUS screen of the readout menu will indicate OFF - SAFETY ACTIVE. The red LED inside the  key lights up and the buzzer inside the controller is activated.

When a network safety occurs in a DICN configuration, the slaves not detected by the network will function as stand alone units.

- If a slave unit can not be found by the network, the red light inside the  key of the master lights up and the buzzer inside the control is activated.
- If the master can not be found by the network, the red light inside the  key of all the slaves light up and the buzzer inside their controls are activated. All units will work as stand alone units.

If the unit has been shut down due to a power failure, it will carry out an autoreset and restart automatically when the electrical power is restored.

To reset the unit, proceed as follows:

- 1 Press the  key to acknowledge the alarm.
The buzzer is deactivated.
The controller automatically switches to the corresponding screen of the safeties menu: unit safety or circuit safety or network safety.
- 2 Find the cause of shutdown and correct.
Refer to "Listing activated safeties and checking the unit status" on page 14 and "Troubleshooting" on page 15.
When a safety can be reset, the LED under the  key starts blinking.
- 3 Press the  key to reset the safeties that are no longer active.
If required, enter the USER PASSWORD or the SERVICE PASSWORD. (Refer to the installation manual "Setting the password for safety reset".)
Once all safety devices are deactivated and reset, the LED under the  key goes out. If one of the safeties is still active, the LED under the  key goes on again. In this case, return to step 2.
- 4 It will only be necessary to switch the  key on again if a unit safety occurs.



If the user shuts down the power supply in order to repair a safety, the safety will automatically be reset after power-up.



NOTE The history information, i.e. the number of times a unit safety or a circuit safety occurred and the unit status at the moment of shutdown, can be checked by means of the history menu.

Advanced features of the digital controller

This chapter gives an overview and a brief functional description of the screens provided by the different menus. In the following chapter, you will find how you can set up and configure the unit using the various menu functions.

All menus are directly accessible using the corresponding key on the digital controller or through the main menu (refer to "How to enter a menu" on page 6). The down arrow \downarrow on the display indicates that you can go to the next screen of the current menu using the \blacktriangledown key. The up arrow \uparrow on the display indicates that you can go to the previous screen of the current menu using the \blacktriangle key. If \div is displayed, this indicates that you can either return to the previous screen or can go to the next screen.

Readout menu

```

└─ INLSETP1 E: 12.0°C
  INL WATER E: 12.0°C
  OUTL WATER E: 07.0°C
  
```

To consult actual operational information about the control mode, the inlet and outlet water temperature (see first screen).

Note that for a DICN system, the INLET WATER and OUTLET WATER values are the values of the individual units, not of the system. Temperatures of the system can be consulted in the first screen of the network menu.

```

└─ UNIT STATUS
  C1:OFF-CAN STARTUP
  UNITCAPACITY:000%
  
```

To consult information about the unit status.

```

└─ ACT. PRESSURES C1
  HP1: 19.0b = 50.8°C
  LP1: 4.4b = 5.2°C
  
```

To consult information about the pressures.

```

└─ EXTRA READOUT
  RH1:00000h CS1:00000
  AMBIENT: 20.0°C
  
```

To consult actual operational information about the ambient temperature, the total running hours of the compressor and the number of compressor starts.

Setpoints menu

Depending upon the settings in the user settings menu, the "setpoints" menu can either be entered directly or by means of the user password.

```

> INLSETP1 E: 12.0°C
  INLSETP2 E: 12.0°C
  OUTLSETP1 E: 07.0°C
  OUTLSETP2 E: 07.0°C
  
```

To define the temperature setpoints.

User settings menu

The "usersettings" menu, protected by the user password, allows a full customization of the units.

```

└─ CONTROL SETTINGS
  MODE:INL WATER
  CIR1: 70%
  F1*:MED
  
```

To define the manual settings and to activate or deactivate manual control mode.

```

└─ THERMOST. SETTINGS
  LOADUP:048s-DWN:024s
  
```

To define the thermostat settings.

```

└─CAP. LIM. SETTINGS
  MODE:REMOTE DIG INP.
  L1CIR1:100%
  L2CIR1:100%
  
```

To define the capacity limitations. (first screen)

```

└─CAP. LIM. SETTINGS
  L3CIR1:100%
  L4CIR1:100%
  
```

To define the capacity limitations. (second screen)

```

└─ PUMPCONTROL
  PUMPLEADTIME: 020s
  PUMPLAGTIME : 000s
  DAILY ON:N AT:12h00
  
```

To define the pump control settings.

```

└─ SCHEDULE TIMER
  ENABLE TIMER:Y
  ENABLE HOLIDAY PER:Y
  
```

To define the schedule timer.

According to the settings of ENABLE TIMER and ENABLE HOLIDAY PER following screens will be available or not.

```

└─HD PERIOD:01 TO 03
  01:00/00 TO 00/00
  02:00/00 TO 00/00
  03:00/00 TO 00/00
  
```

To define the dual evaporator pump.

```

└─ DUAL EVAP. PUMP
  MODE:AUTOM. ROTATION
  OFFSET ON RH: 048h
  
```

```

└─ FLOATING SETPOINT
  MODE:AMBIENT
  MAX. VALUE:3.0°C
  D1:03.0°C D2:05.0°C
  
```

To define the floating setpoint.

```

└─ DISPLAY SETTINGS
  PRESS ENTER TO
  CHANGE LANGUAGE:
  ENGLISH
  
```

To define the display settings (first screen).

```

└─ DISPLAY SETTINGS
  TIME: 00h00
  DATE: MON 01/01/01
  
```

To define the display settings (second screen).

```

└─ FREE COOLING
  MODE : NOT ACTIVE
  
```

To define the free cooling.

```

└─ MASTER SETTING
  NR OF SLAVES:2
  
```

To define the number of slaves for a "master" unit. This menu can only be accessed at the "master" unit!

```

└─ MASTER SETTINGS
  MODE:NORMAL
  OFFSET:0000h
  PUMP ON IF:UNIT ON
  
```

The controller displays the name of the unit: MASTER, SLAVE1 ... SLAVE3. This name is automatically assigned depending on the set hardware address. Refer to "Setting the addresses" in "Connection and setup of a DICN system" in the installation manual.

```

└─ SETPOINT PASSWORD
  PASSWORD NEEDED TO
  CHANGE SETPOINTS: Y
  
```

To define whether or not a password is needed to enter the setpoints menu.

```

└─ ENTER SERVICE
  PASSWORD: 0000
  
```

To enter the service menu (only a qualified installer is allowed to access this menu).

Timers menu

```

└─ GENERAL TIMERS
  LOADUP:000s-DWN:000s
  PUMPLEAD : 000s
  FLOWSTOP : 00s 2*00s
  
```

To check the actual value of the general software timer.

```

└─ COMPRESSOR TIMERS
  COMPR. STARTED :00s
  
```

To check the actual value of the compressor timer. (first screen)

```

└─ COMPRESSOR TIMERS
  GRD1:000s AREC1:000s
  
```

To check the actual value of the compressor timer. (second screen)

```

└─ COMPRESSOR TIMERS
  START1:000s STOP:00s
  
```

To check the actual value of the compressor startup timer and the stop timer.

Safeties menu

The "safeties" menu provides useful information for trouble shooting purposes. The following screens contain basic information.

```
UNIT SAFETY
0HC:INL C SENSOR ERR
```

To consult information about the unit safety which caused the shutdown.

```
CIRCUIT1 SAFETY
IU1:REV PHASE PROT
```

To consult information about the circuit safety which caused the shutdown.

```
NETWORK SAFETY
0U4:PCB COMM.PROBLEM
```

To consult information about the network safety which caused the shutdown.

```
UNIT WARNING
0AE:FLOW HAS STOPPED
```

To consult information about the dual pump which caused the shutdown.

Along with the basic information, more detailed information screens can be consulted while the safety menu is active. Press the \odot key. Screens similar to the following will appear.

```
UNIT HISTORY:002
0HC:INL C SENSOR ERR
00h00 - 01/01/01
MANUAL MODE
```

To check the time and control mode at the moment of the unit shutdown.

```
UNIT HISTORY:002
0HC:INL C SENSOR ERR
INL.E: 12.0°C
OUT.E: 07.0°C
```

To check which were the evaporator and condenser inlet water temperature and the evaporator outlet water temperature.

```
UNIT HISTORY:002
0HC:INL C SENSOR ERR
C1:OFF-CAN STARTUP
```

To check which was the status of the compressors at the moment of shutdown.

```
UNIT HISTORY:002
0HC:INL C SENSOR ERR
HP1: 19.0b = 50.8°C
LP1: 4.4b = 5.2°C
```

To check which were the pressures of the circuit at the moment of shutdown.

```
UNIT HISTORY:002
0HC:INL C SENSOR ERR
RH 1:00000h AMB.T:
20.0°C
```

To check which were the total amount of running hours of the compressor and the ambient temperature at the moment of shutdown.

History menu

The "history" menu contains all the information concerning the latest shutdowns. The structure of those menus is identical to the structure of the safeties menu. Whenever a failure is solved and the operator performs a reset, the concerning data from the safeties menu is copied into the history menu.

Additionally the number of safeties that already occurred, can be consulted on the first line of the history screens.

Info menu

```
TIME INFORMATION
TIME: 00h00
DATE: MON 01/01/01
```

To consult time and date information.

```
UNIT INFORMATION
UNIT:AW-CO-110 C:STL
CIR:1 EVAP:1 FAN:3ST
REFRIGERANT :R407C
```

To consult additional information about the unit such as the unit type and the refrigerant used.

```
UNIT INFORMATION
SW:4.0M6 -01/08/05
SW CODE: FLDKKNMCHLA
```

To consult information about the controller's software version.

```
PCB INFORMATION
BOOT:U3.01-15/04/02
BIOS:U3.61-05/11/04
PLAN ADDRESS:01
```

To consult information about the PCB.

Input/output menu

The "input/output" menu gives the status of all the digital inputs and the relay outputs of the unit.

```
DIGITAL INPUTS
EMERGENCY STOP :OK
FLOWSWITCH:FLOW OK
```

To check whether or not the emergency stop device is active and if there is any waterflow to the evaporator.

```
DIGITAL INPUTS
C1 HIGH PR.SW. :OK
C1 REV.PH.PROT.:OK
C1 OVERCURRENT :OK
```

To check the status of the high pressure switch, the reverse phase protector and the overcurrent relay.

```
DIGITAL INPUTS
C1 DISCH.TH.PR.:OK
C1 COMPR.TH.PR.:OK
```

To check the status of the discharge thermal protector and the compressor thermal protector.

```
CHANG. DIG. INPUTS
DI1 NONE
DI2 NONE
DI3 NONE
```

To check the status of the changeable digital inputs.
Note that for a unit in a DICN system, the inputs apply to this unit. It will be the remote input on the master unit however, that will be determining for the operation of the unit.

```
RELAY OUTPUTS
CIRCUIT 1 ON :NO
CIRCUIT 1 STAR :NO
CIRCUIT 1 DELTA:NO
```

To check the status of the power relays.

```
RELAY OUTPUTS
C1<12%>:N
C1CAPUP:N DOWN:N
C1FEEDBACK: 030.0s
```

To check the capacity mode and feedback.

```
RELAY OUTPUTS
C1 FANSTEP 1:CLOSED
C1 FANSTEP 2:CLOSED
C1 FANSTEP 3:CLOSED
```

To check the status of the fanspeed relays.

```
RELAY OUTPUTS
GEN. ALARM:CLOSED
PUMP/GEN OPER:CLOSED
AI1:NONE
```

To check the status of the pump, the alarm and the evaporator heater voltage free contacts.

```
CHANG. INP/OUTPUTS
DI4 NONE
DO1 EVAP.HEATERT. :C
DO2 100% CAPACITY :0
```

To check the status of the changeable relay output.

User password menu

```
CHANGE PASSWORD
NEW PASSWORD: 0000
CONFIRM: 0000
```

To change the user password.

Network menu

The "network" menu provides useful information regarding the network.

```
LV NETWORK
INLSETP1 E: 12.0°C
INL WATER E: 12.0°C
```

To consult the temperature setpoint, the common entering water temperature (entering water temperature of the master unit) and the common leaving water temperature (only displayed when **OUTLET CONTROL** mode is set and the optional common leaving water sensor (R8T) is installed). Refer to "Defining and activating the control mode" on page 11.

```
^ M: NORMAL CAP: 100%
SL1: STANDBY CAP: 100%
SL2: DISCONN. CAP: 000%
SL3: SAFETY CAP: 000%
```

The status screen of the network menu shows the condition of the master unit (M) and slave units (SL1 ... SL3).

Tasks of the user settings menu

Entering the user settings menu

The user settings menu is protected by the user password, a 4-digit number between 0000 and 9999.

- 1 Enter the **USERSETTINGS MENU**. (Refer to the chapter "How to enter a menu" on page 6).
The controller will request the password.
- 2 Enter the correct password using the **▲** and **▼** keys.
- 3 Press **⊙** to confirm the password and to enter the user settings menu.
The controller automatically enters the first screen of the user settings menu.

To define settings of a certain function:

- 1 Go to the appropriate screen of the usersettings menu using the **▲** and **▼** keys.
- 2 Position the cursor behind the parameter to be modified using the **⊙** key.
- 3 Select the appropriate setting using the **▲** and **▼** keys.
- 4 Press **⊙** to confirm the selection.
When the selection has been confirmed, the cursor switches to the next parameter which can now be modified.
- 5 Repeat from instruction 2 onwards to modify the other parameters.

Defining and activating the control mode

The unit is equipped with a thermostat which controls the cooling capacity of the unit. Three different control modes exist:

- manual control mode: the operator controls the capacity himself - **MANUAL CONTROL** - by setting:
 - F1* (air flow in manual mode): off, low, medium or high.
 - CIR1 (capacity step in manual mode): 0%, 30%~100%.
- inlet control mode: uses the evaporator entering water temperature to control the capacity of the unit - **INLET WATER**
- outlet control mode: uses the evaporator leaving water temperature to control the capacity of the unit - **OUTLET WATER**

NOTE  To activate manual control mode, select **MANUAL** as present mode. To deactivate the manual control mode, select **INLET WATER** or **OUTLET WATER** as present mode.

For units in a DICN configuration:

When changing the control mode on one of the units, it is automatically transferred to all other units.

Manual control mode however can only be selected on units with status **DISCONNECT ON/OFF**.

Defining the thermostat settings

When automatic control mode is selected, the unit uses a thermostat function to control the cooling capacity. However, the thermostat parameters are not fixed and can be modified via the **THERMOST. SETTINGS** screen of the user settings menu.

The default, limit and step values for the thermostat parameters are shown in "Annex I" on page 18.

- NOTE** 
- If changed on one of the units in a DICN configuration, this setting is transferred to all other units in the network.
 - A functional diagram showing the thermostat parameters can be found in "Annex I" on page 18.

Defining the capacity limitation settings

In the **CAP. LIM. SETTINGS** screen up to four possible capacity limitation settings can be configured.

A capacity limitation can be activated:

- **MODE:**
 - **SCHEDULE TIMER:** see "Defining the schedule timer" on page 11.
 - **REMOTE DIG INP:** when a changeable input is configured as capacity limitation.

NOTE  Refer to "Customization in the service menu", chapter "Setting of the changeable digital inputs and outputs" in the installation manual

- **LIM1:** to activate capacity limitation 1.
- **NOT ACTIVE:** the capacity limitation is not active.
- **L1/L2/L3/L4 CIR 1:** capacity limitation value of circuit 1 in case of capacity limitation 1/2/3/4.

Defining the pump control settings

The **PUMPCONTROL** screen of the user settings menu allows the user to define the pump-leadtime and pump-lagtime.

- **PUMPLEADTIME:** used to define the time that the pump must run before the unit (or the compressor in case **PUMP ON IF: COMPRESSOR ON** is selected in a DICN configuration) can start up.
- **PUMPLAGTIME:** used to define the time that the pump keeps running after the unit (or the compressor in case **PUMP ON IF: COMPRESSOR ON** is selected in a DICN configuration) has been stopped.

Defining the schedule timer

To activate the screens of the schedule timer or holiday period, these first need to be enabled by changing their setting to **Y** in the appropriate screen. To de-activate the schedule timer or holiday period, their setting needs to be reset to **N**. (See "Usersettings menu" on page 9.)

The **SCHEDULE TIMER** screen of the user settings menu allows the user to define the schedule timer settings.

Each day of the week can be appointed to a group. The actions defined in a group will be executed in each day belonging to that group.

- **MON, TUE, WED, THU, FRI, SAT and SUN:** used to define to which group each day of the week belongs (-/G1/G2/G3/G4).
- For each of the four groups up to nine actions can be set, each with their respective timing. Actions include: putting the unit on (**ON**), putting the unit off (**OFF**), setting a setpoint (**ISP1 E, ISP2 E, OSP1 E, OSP2 E**) and setting capacity limitation (**LIM1, LIM2, LIM3, LIM4, NO LIM**).

- Beside these four groups there is also a holiday period group which is set the same way as the other groups. Up to 12 holiday periods can be entered in the **HOLIDAY PERIOD** screen. During these periods the schedule timer will follow the settings of the holiday period group.

NOTE  A functional diagram showing the schedule timer working can be found in "[Annex II](#)" on page 18.

NOTE  The unit always works with "last command". This means that the last command given, whether manually by the user or by the schedule timer, is always executed.

Examples of command that can be given are switching the unit on/off or changing a setpoint.

NOTE  In case of a DICN network, defining the schedule timer will only be possible through the master unit. In case of power failure of the master unit, the slave units however, will still operate according to settings of the schedule timer.

Defining dual evaporator pump control

The **DUAL EVAP. PUMP** screen of the user settings menu allows the user to define the steering of two evaporator pumps (for this to be possible a changeable digital output has to be configured for a second evaporator pump in the service menu). Refer to the installation manual.

- **MODE**: used to define which kind of control will be used for the two evaporator pumps. When automatic rotation is chosen the offset on running hours also has to be entered.
 - **AUTO**: pump 1 and pump 2 will alternate to the offset on RH.
 - **PUMP 1>PUMP 2**: pump 1 will always start up first.
 - **PUMP 2>PUMP 1**: pump 2 will always start up first.
- **OFFSET ON RH**: used to define the offset in running hours between the two pumps. Used to switch over between pumps when they work in automatic rotation mode.

Defining the floating setpoint settings

The **FLOATING SETPOINT** screen of the user settings menu allows the active setpoint to be modified in function of the ambient. The source and settings of the floating setpoint can be configured by the user.

- **SOURCE**: used to define the mode of the floating setpoint.
 - **NOT PRESENT**: floating setpoint is not activated.
 - **AMBIENT**: floating setpoint is altered based on the ambient temperature.
- **MAX. VALUE**: used to define maximum value that can be added to the active setpoint.
- **D1**: used to define the ambient (source) at which the floating setpoint value is equal to zero.
- **D2**: used to define the rise in floating setpoint value for 10°C drop in ambient.

NOTE  A functional diagram showing the floating setpoint working can be found in "[Annex III](#)" on page 19.

Defining the display settings

The **DISPLAY SETTINGS** screens of the usersettings menu allows the user to define the choice of language, time and date.

- **LANGUAGE**: used to define the language of the displayed information of the controller (on the first screen). (Push the  button repeatedly to change the operating language).
- **TIME**: used to define the present time (on the second screen).
- **DATE**: used to define the present date (on the second screen).

Defining free cooling

The **FREE COOLING** screen of the usersettings menu allows the user to control a 3-way water valve when the unit is in free cooling state. To make this possible a changeable digital output has to be configured for free cooling in the service menu. (Refer to the installation manual.)

- **MODE**: used to define the free cooling mode.
 - **NOT ACTIVE**: free cooling is not active.
 - **AMBIENT**: free cooling is based on ambient temperature.
 - **INLET-AMBIENT**: free cooling is based on the difference between inlet water temperature and ambient temperature.
- **SP**: setting of the free cooling setpoint.
- **DI**: setting of the free cooling difference.

NOTE  A functional diagram showing the free cooling working can be found in "[Annex IV](#)" on page 19.

Defining the network settings

The **NETWORK** screen of the user settings menu allows the user to define the network settings.

- **NR OF SLAVES**: Define the number of slaves connected to the master (1 to 3). This menu can only be accessed at the "Master" unit.

The **SETTINGS** screen of the network menu allows the user to set the **MODE** of the unit, the **OFFSET** time and the condition when the pump must operate.

- **MODE**: Define the mode of the unit as **NORMAL**, **STANDBY** or **DISCONN ON/OFF**.
 - **NORMAL**: The unit is controlled by the network. Loading and unloading is decided by the central control of the network. Putting this unit ON or OFF will also put all other units ON or OFF, unless their status is **DISCONNECT ON/OFF**. (see further) Changing **CONTROL SETTINGS** or **THERMOSTAT SETTINGS** to this unit, will apply to all other units. **MANUAL CONTROL** on such a unit is not possible. Refer to "[Defining and activating the control mode](#)" on page 11.
 - **STANDBY**: The unit is considered as a **NORMAL** unit and its function is then also similar to a unit defined as **NORMAL**, but this unit however, will only come into operation if:
 - another unit is in alarm
 - another unit is in **DISCONNECT ON/OFF** mode
 the setpoint is not reached when all other units have been running on full capacity for some time
If more than one unit is defined as **STANDBY**, only 1 of the units will be really standby. The unit which is really standby will be decided by the number of running hours.
 - **DISCONNECT ON/OFF**: Putting this unit ON or OFF will not put other units ON or OFF. **MANUAL CONTROL** on such a unit is possible.
If the unit is put to **AUTOMATIC CONTROL**, and the unit is ON, it will be controlled by the DICN network as a **NORMAL** unit.

NOTE

Put a unit to DISCONNECT ON/OFF when servicing the machine. In this case it is possible to switch ON or OFF this unit without switching ON or OFF the other units of the network.

It is also possible then to operate the unit in MANUAL CONTROL.

Put a unit to DISCONNECT ON/OFF continuously if the operator wants to decide by himself when this unit must operate.

Note that in this case, it makes no sense to define another unit of the network as STANDBY. Since there is a unit set continuously to DISCONNECT ON/OFF, the STANDBY unit will continuously be considered as a NORMAL unit.

- **OFFSET:** The OFFSET time defines the target difference in running hours between one unit and another unit with OFFSET:0000 h. This value is important for maintenance purposes. The difference in setting among different units should be high enough as to avoid servicing of the units all at the same time. The lower and upper limits are 0 and 9000 hours respectively. The default value is 0 hours.
- **PUMP ON IF:** Set if the pump must operate as long as the chiller is on (UNIT ON), or during compressor on condition only (COMPR ON).
When UNIT ON is selected, the voltage free contact S9L will remain closed as long as the chiller is on. When COMPR ON is selected, the voltage free contact S9L will remain closed as long as the compressor is on.
Also refer to the separate manual "Installation examples for a DICN configuration".

NOTE

The settings on this screen of the network menu must be executed for all chillers connected to the system.

Activating or deactivating the setpoints password

The SETPOINT PASSWORD screen of the user settings menu allows the user to activate or deactivate the user password needed to change the temperature setpoint. When deactivated, the user does not have to enter the password each time he wants to change the setpoint.

NOTE

If changed on one of the units in a DICN configuration, this setting is automatically transferred to all the other units in the network.

Defining BMS control

BMS allows the user to control the unit from a supervisory system.

The BMS SETTINGS screen and BMSBOARD SETTINGS screen of the service menu have to be used to set BMS parameters. Refer to "Customization in the service menu" chapter "Defining the BMS settings" in the installation manual.

Tasks of the timers menu

Checking the actual value of the software timers

As a protective measure and to ensure correct operation, the controller's software features several countdown timers:

- **LOADUP (LOADUP – refer to the thermostat parameters):** starts counting when a thermostat step change has occurred. During the countdown, the unit is not able to enter a higher thermostat step.
- **LOADDOWN (DOWN – refer to the thermostat parameters):** starts counting when a thermostat step change has occurred. During the countdown, the unit will not be able to go to a lower thermostat step.
- **FLOWSTART (FLOWSTART – 15 sec):** counts down when the waterflow through the evaporator is continuous and the unit is in standby. During the countdown, the unit cannot start up.
- **FLOWSTOP (FLOWSTOP – 5 sec):** starts counting when the waterflow through the evaporator stops after the flowstart timer has reached zero. If the waterflow has not restarted during the countdown, the unit will shut down.
- **PUMPLEAD (PUMPLEAD – refer to the pump control settings):** starts counting whenever the unit is switched on. During the countdown, the unit cannot start up.
- **PUMPLAG (PUMPLAG – refer to the pump control settings):** starts counting whenever the unit is switched off. During the countdown, the pump keeps running.
- **STARTTIMER (COMPR. STARTED – 10 sec):** starts counting whenever a compressor starts up. During the countdown, no other compressor can start up.
- **GUARDTIMER (GRD1 – 60 sec):** starts counting when the compressor has been shut down. During the countdown, the compressor cannot be restarted.
- **ANTIRECYCLING (AREC1 – 600 sec):** starts counting when the compressor has started. During the countdown, the compressor cannot be restarted.
- **STARTUPTIMER (STARTUPTIME1 – 180 sec):** starts counting when the compressor has started. During the countdown, the compressor is limited to a maximum capacitystep of 30%.

To check the actual value of the software timers, proceed as follows:

- 1 Enter the TIMERS MENU. (Refer to the chapter "How to enter a menu" on page 6.)
The controller displays the actual value of the GENERAL TIMERS: the loadup timer, the loaddown timer, the flowstart timer, the flowstop timer (when the unit is on and the flowstart timer has reached zero), the pumplead timer and the pumplag timer.
- 2 Press the key to check the compressor timers.
The controller shows the actual value of the COMPRESSOR TIMERS: the guard timers (one per circuit) and the antirecycling timers (one per circuit).
- 3 Press the key to check the remaining timers.
The controller shows the actual value of the STARTUP TIMERS.







Tasks of the safeties menu

Listing activated safeties and checking the unit status

If the alarm buzzer is activated and the user presses the  key, the controller automatically enters the safeties menu.

- The controller will enter the UNIT SAFETY screen of the safeties menu when a unit safety was the cause of shutdown.
- The controller will enter the CIRCUIT 1 SAFETY screen of the safeties menu when a safety of the circuit was activated.
- For a DICN system, the controller can also show: NETWORK SAFETY PCB COMMUN. PROBLEMS. This occurs when the wrong number of slave units is defined (refer to "Defining the network settings" on page 12) or when a slave unit is missing (because of bad connection or power supply failure).
Make sure to define the correct number of slave units and to make correct connections.

NOTE You can check the "found" slave units in the 2nd screen of the network menu.



- When the unit is configured with a dual evaporator pump, the controller will enter the DUAL PUMP SAFETY screen of the safeties menu when a safety on the pump was the cause of shutdown.
- 1 Press the  key when the alarm buzzer is activated.
The appropriate safety screen with the basic information appears. Press the  key to see the detailed information. These screens provide information about the unit status at the moment of shutdown (see "Safeties menu" on page 10).
 - 2 If more than one kind of safety is active (indicated by means of ,  or ), use the  and  keys to consult them.

Tasks of the history menu

Checking the safety info and the unit status after a reset



The information available in the safeties menu is also stored in the history menu, where it is stored after resetting the unit or the circuit. In this way, the history menu provides a means of checking the unit status at the moment of the latest shutdown.

To check the safety info and the unit status, proceed as follows:

- 1 Enter the HISTORY MENU. (Refer to the chapter "How to enter a menu" on page 6).
The controller enters the last HISTORY screen which contains basic information of the moment of this shutdown.
- 2 Press the  and  keys to consult the other present HISTORY screens.
- 3 Press the  key to see the detailed information.

Tasks of the info menu

Consulting additional unit information

- 1 Enter the INFO MENU through the main menu. (Refer to the chapter "How to enter a menu" on page 6).
The controller enters the TIME INFORMATION screen which contains the following information: the time and date.
- 2 Press  to consult the first UNIT INFORMATION screen.
This screen contains information about the unit name and the refrigerant used.
- 3 Press  to consult the next UNIT INFORMATION screen.
This screen contains information about the controller's software version.
- 4 Press  to consult the PCB INFORMATION screen.
This screen contains information about the PCB.

Tasks of the input/output menu

Checking the status of the inputs and outputs

The input/output menu provides a means of checking the status of the digital inputs and the status of the relay outputs.

The locked digital inputs are:

- EMERGENCY STOP: whether the emergency button has been pressed.
- FLOWSWITCH: indicates the status of the flowswitch: activated or deactivated.
- HIGH PRESSURE SWITCH 1: indicates the actual status of this safety.
- REVERSE PHASE PROTECTOR 1: indicates the actual status of this safety.
- OVERCURRENT 1: indicates the actual status of this safety.
- DISCHARGE THERMAL PROTECTOR 1: indicates the actual status of this safety.
- COMPRESSOR THERMAL PROTECTOR 1: indicates the actual status of this safety.

The changeable digital inputs are:

- CAP LIM 1/2/3/4: indicates the position of the "enable/disable capacity limitation" switches.
- DUAL SETPOINT: indicates the position of the remote dual setpoint switch: setpoint 1 or setpoint 2.
- REM. ON/OFF: indicates the position of the remote on/off switch.
- STATUS: indicates the position of the connected switch.

The locked relay outputs are:

- CIRCUIT 1 ON: indicates whether the circuit is on or off.
- CIRCUIT 1 STAR: indicates whether the circuit is in starmode or not.
- CIRCUIT 1 DELTA: indicates whether the circuit is in deltamode or not.
- C1 <12%>: indicates if the 12% capacity valve of the circuit is activated.
- C1 CAPUP: indicates if the UP of the capacity control motor of the circuit is activated.
- C1 CAPDOWN: indicates if the DOWN of the capacity control motor of the circuit is activated.
- C1 FEEDBACK: indicates the FEEDBACK of the potentiometer of the circuit (Ω).
- C1 FANSTEP 1: indicates if the fans of fanstep 1 for the circuit are on or not.
- C1 FANSTEP 2: indicates if the fans of fanstep 2 for the circuit are on or not.
- C1 FANSTEP 3: indicates if the fans of fanstep 3 for the circuit are on or not.
- PUMPCONTACT: indicates the status of this voltage free contact. It is activated if the pump should be ON.
- GEN. ALARM: indicates the status of this voltage free contact. It is activated if there is any alarm on the unit.
- EVAP. HEATER: indicates the status of the evaporator heater.

The changeable relay outputs are:

- 2ND EVAP PUMP: indicates the status of the second evaporator pump.
- 100% CAPACITY: indicates when the unit is working at 100%.
- FREE COOLING: indicates the status of the 3-way water valve when the unit is in free cooling state.
- 1 <CLOSED>: indicates the closed status of the changeable digital output.

The changeable analog inputs are:

- SETP.SIGN. 0mV: indicates the status of the analog input
- SETP.SIGN. 0.0V: indicates the status of the analog input
- SETP.SIGN. 0mA: indicates the status of the analog input
- MS OUT E: indicates the status of the analog input

To check the inputs and outputs, proceed as follows:

- 1 Enter the I/O STATUS MENU. (Refer to the chapter "How to enter a menu" on page 6.)
The controller enters the first DIGITAL INPUTS screen.
- 2 Consult the other screens of the input/output menu using the ▲ and ▼ keys.

Tasks of the user password menu

Changing the user password

Access to the user settings menu and the setpoints menu is protected by the user password (a 4-digit number between 0000 and 9999).

NOTE The default user password is 1234.



To change the user password, proceed as follows:

- 1 Enter the USERPASSWORD MENU. (Refer to the chapter "How to enter a menu" on page 6.)
The controller will request the password.
- 2 Enter the correct password using the ▲ and ▼ keys.
- 3 Press ⏻ to confirm the password and to enter the password menu.
The controller requests the new password.
- 4 Press ⏻ to start the modification.
The cursor is positioned behind NEW PASSWORD.
- 5 Enter the new password using the ▲ and ▼ keys.
- 6 Press ⏻ to confirm the new password.
When the new password has been confirmed, the controller will ask to enter the new password a second time (for safety reasons). The cursor is positioned behind CONFIRM.
- 7 Enter the new password again using the ▲ and ▼ keys.
- 8 Press ⏻ to confirm the new password.

NOTE The actual password will only be changed when the new password and the confirmed password have the same value.

If changed on one of the units in a DICN configuration, this setting is automatically transferred to all the other units in the network.

TROUBLESHOOTING

This section provides useful information for diagnosing and correcting certain troubles which may occur in the unit.

Before starting the trouble shooting procedure, carry out a thorough visual inspection of the unit and look for obvious defects such as loose connections or defective wiring.

Before contacting your local dealer, read this chapter carefully, it will save you time and money.



When carrying out an inspection on the supply panel or on the switch box of the unit, always make sure that the circuit breaker of the unit is switched off.

Overview of safety messages

Message safety menu		Symptom
UNIT SAFETY	0F0:EMERGENCY STOP	3
	0AE:FLOW HAS STOPPED	5.7
	0A4:FREEZE UP	5.8
	0C9:INL E SENSOR ERR	13
	0CA:OUT E SENSOR ERR	13
	0H9:AMB T SENSOR ERR	13
CIRCUIT 1 SAFETY	1U1:REV PHASE PROT	5.6
	1E3:HIGH PRESSURE SW	5.3
	1E5:COMPR THERM PROT	5.9
	1E6:OVERCURRENT	5.1
	1F3:DISCH THERM PROT	5.6
	1E4:LOW PRESSURE	5.2
	1JA:HP TRANSM ERR	13
	1JC:LP TRANSM ERR	13
	193:CONTR.MOTOR ERR	11
	194:CONTR.MOTOR REV	12
NETWORK SAFETY	0U4:PCB COMM.PROBLEM	10
	0CA:OUT E SENSOR ERR	13
	0C9:INL E SENSOR ERR	13
UNIT WARNING	0AE:FLOW HAS STOPPED	5.7

When a safety device was activated, stop the unit and find out why the safety device was activated before resetting it. Under no circumstances safety devices may be bridged or changed to a value other than the factory setting. If the cause of the problem cannot be found, call your local dealer.

Symptom 1: The unit does not start, but the ON LED lights up

POSSIBLE CAUSES	CORRECTIVE ACTION
The temperature setting is not correct.	Check the controller setpoint.
The flowstart timer is still running.	The unit will start after approx. 15 seconds. Make sure that water is flowing through the evaporator.
The circuit can not start up.	Refer to Symptom 4: The circuit does not start up.
Unit is in manual mode (all compressors at 0%).	Check on the controller.
Power supply failure.	Check the voltage on the supply panel.
Blown fuse or interrupted protection device.	Inspect fuses and protection devices. Replace by fuses of the same size and type (refer to "Electrical specifications" on page 1).
Loose connections.	Inspect connections of the field wiring and the internal wiring of the unit. Tighten all loose connections.
Shorted or broken wires.	Test circuits using a tester and repair if necessary.

Symptom 2: The unit does not start, but the ON LED is flashing

POSSIBLE CAUSES	CORRECTIVE ACTION
The remote ON/OFF input is enabled and the remote switch is off.	Put the remote switch on or disable the remote ON/OFF input.

Symptom 3: The unit does not start and the ON LED does not light up

POSSIBLE CAUSES	CORRECTIVE ACTION
The unit is in failure mode.	Refer to Symptom 5: One of the following safety devices is activated.
One of the following safety devices is activated: <ul style="list-style-type: none"> • Flowswitch (S8L,S9L) • Emergency stop 	Refer to Symptom 5: One of the following safety devices is activated.
The ON LED is broken.	Contact your local dealer.

Symptom 4: The circuit does not start up

POSSIBLE CAUSES	CORRECTIVE ACTION
One of the following safety devices is activated: <ul style="list-style-type: none"> Compressor thermal protector (Q*M) Overcurrent relay (K*S) Discharge thermal protector (S*T) Low pressure High pressure switch (S*PH) Reverse phase protector (R*P) Freeze-up 	Check on the controller and refer to Symptom 5: One of the following safety devices is activated .
The anti-recycling timer is still active.	The circuit can only start up after approximately 10 minutes.
The guard timer is still active.	The circuit can only start up after approximately 1 minute.
The circuit is limited to 0%.	Check the enable/disable capacity limitation remote contact.

Symptom 5: One of the following safety devices is activated

Symptom 5.1: Overcurrent relay of compressor	
POSSIBLE CAUSES	CORRECTIVE ACTION
Failure of one of the phases.	Check fuses on the supply panel or measure the supply voltage.
Voltage too low.	Measure the supply voltage.
Overload of motor.	Reset. If the failure persists, call your local dealer.
RESET	<i>Push the blue button on the over-current relay inside the switch box and reset the controller.</i>
Symptom 5.2: Low pressure	
POSSIBLE CAUSES	CORRECTIVE ACTION
Waterflow to water heat exchanger too low.	Increase the waterflow.
Shortage of refrigerant.	Check for leaks and refill refrigerant, if necessary.
Unit is working out of its operation range.	Check the operation conditions of the unit.
Inlet temperature to the water heat exchanger is too low.	Increase the inlet water temperature.
Dirty evaporator.	Clean the evaporator or call your local dealer.
Low pressure safety setting too high.	Refer to the installation manual "Customization in the service menu", paragraph "Setting of the minimum outlet water temperature" for correct values.
Flowswitch is not working or no waterflow.	Check the flowswitch and the water pump.
RESET	<i>After pressure rise, this safety resets automatically, but the controller still needs to be reset.</i>
Symptom 5.3: High-pressure switch	
POSSIBLE CAUSES	CORRECTIVE ACTION
Condenser fan does not operate properly.	Check that the fans turn freely. Clean if necessary.
Dirty or partially blocked condenser.	Remove any obstacle and clean condenser coil using brush and blower.
Inlet air temperature of the condenser is too high.	The air temperature measured at the inlet of the condenser may not exceed 43°C.
Fan turning in the wrong direction.	Two phases of the power supply to the fan motor must be inverted (by a licensed electrician).
RESET	<i>After pressure decrease, push the button on the high-pressure switch and reset the controller.</i>

Symptom 5.4: Fan thermal protector is activated	
POSSIBLE CAUSES	CORRECTIVE ACTION
Mechanical failure (fan is blocked).	Check that the fan rotates freely.
Air flow in the unit too low or outdoor temperature too high.	Clean the air heat exchanger properly.
RESET	<i>After temperature decrease, the thermal protector is reset automatically. If the protector is activated frequently, replace the motor or call your local dealer.</i>
Symptom 5.5: Reverse phase protector is activated	
POSSIBLE CAUSES	CORRECTIVE ACTION
Two phases of the power supply are connected in the wrong phase position.	Invert two phases of the power supply (by licensed electrician).
One phase is not connected properly.	Check the connection of all phases.
RESET	<i>After inverting two phases or fixing the power supply cables properly, the protector is reset automatically, but the controller still needs to be reset.</i>
Symptom 5.6: Discharge thermal protector is activated	
POSSIBLE CAUSES	CORRECTIVE ACTION
Unit is working outside the operation range.	Check the operation condition of the unit.
RESET	<i>After temperature decrease, the thermal protector resets automatically but the controller still needs to be reset.</i>
Symptom 5.7: Flowswitch is activated	
POSSIBLE CAUSES	CORRECTIVE ACTION
No waterflow or too low waterflow.	Check the water pump and the water circuit for obstructions.
RESET	<i>After finding the cause, the flowswitch is reset automatically, but the controller still needs to be reset.</i>
Symptom 5.8: Freeze-up protection is activated	
POSSIBLE CAUSES	CORRECTIVE ACTION
Waterflow too low.	Increase the waterflow.
Inlet temperature to the evaporator is too low.	Increase the inlet water temperature.
Flowswitch is not working or no waterflow.	Check the flowswitch and the water pump.
RESET	<i>After temperature increase the freeze-up is reset automatically, but the circuit controller needs to be reset.</i>
Symptom 5.9: Compressor thermal protector is activated	
POSSIBLE CAUSES	CORRECTIVE ACTION
Compressor motor coil temperature too high.	Compressor is not cooled sufficiently by the refrigerant medium.
RESET	<i>After temperature decrease the thermal protector is reset automatically, but the circuit controller needs to be reset. If the protector is activated frequently, call your local dealer.</i>

Symptom 6: Unit stops soon after operation

POSSIBLE CAUSES	CORRECTIVE ACTION
The schedule timer is activated and is in off mode.	Work according to the settings in the schedule timer or disable the schedule timer.
One of the safety devices is activated.	Check safety devices (refer to Symptom 5: One of the following safety devices is activated).
Voltage is too low.	Test the voltage in the supply panel and, if necessary, in the electrical compartment of the unit (voltage drop due to supply cables is too high).

Symptom 7: Unit runs continuously and the water temperature remains higher than the temperature set on the controller

POSSIBLE CAUSES	CORRECTIVE ACTION
The temperature setting on the controller is too low.	Check and adjust the temperature setting.
The heat production in the water circuit is too high.	The cooling capacity of the unit is too low. Call your local dealer.
Waterflow is too high.	Recalculate the waterflow.

Symptom 8: Excessive noises and vibrations of the unit

POSSIBLE CAUSES	CORRECTIVE ACTION
Unit has not been fixed properly.	Fix the unit as described in the installation manual.

Symptom 9: The display shows NO LINK (only in a DICN system)

POSSIBLE CAUSES	CORRECTIVE ACTION
The addresses set on the PCB or controller are wrong.	Make sure to set the correct addresses. Refer to "Setting the addresses" in the installation manual.

Symptom 10: The NETWORK SAFETY message shows PCB COMMUN. PROBLEM

POSSIBLE CAUSES	CORRECTIVE ACTION
A unit can not be found by the DICN system.	Make sure all units in the DICN system are powered or make sure the correct number of slaves is defined in the master unit.

Symptom 11: The alarm message shows CONTR. MOTOR ERR

POSSIBLE CAUSES	CORRECTIVE ACTION
The control motor is not reacting due to bad wiring to the motor or the motor is damaged.	Check if the wiring to the control motor is correct and not damaged or loose.

Symptom 12: The alarm message shows CONTR. MOTOR REV

POSSIBLE CAUSES	CORRECTIVE ACTION
The control motor is operating in reverse due to wrong wiring.	Check if the wiring is according to the wiring diagram.

Symptom 13: Sensor or transmitter error

POSSIBLE CAUSES	CORRECTIVE ACTION
The wiring is wrong.	Check if the wiring is according to the wiring diagram. Call your local dealer.

MAINTENANCE

In order to ensure optimal availability of the unit, a number of checks and inspections on the unit and the field wiring have to be carried out at regular intervals.

If the unit is used for air conditioning application, the described checks must be executed at least once a year. In case the unit is used for other applications, the checks must be executed every 4 months.



Before carrying out any maintenance or repair activity, always switch off the circuit breaker on the supply panel, remove the fuses or open the protection devices of the unit.

Never clean the unit with water under pressure.

Maintenance activities



The wiring and power supply must be checked by a licensed electrician.

- **Air heat exchanger**
Remove dust and any other contaminant from the coil fins using a brush and a blower. Blow from the inside of the unit. Take care not to bend or damage the fins.
- **Field wiring and power supply**
 - Check the power supply voltage on the local supply panel. The voltage must correspond to the voltage marked on the identification label of the unit.
 - Check the connections and make sure they are properly fixed.
 - Check the proper operation of the circuit breaker and the earth leak detector provided on the local supply panel.
- **Internal wiring of the unit**
Visually check the switch boxes on loose connections (terminals and components). Make sure that the electrical components are not damaged or loose.
- **Earth connection**
Make sure that the earth wires are still connected properly and that the earth terminals are tightened.
- **Refrigerant circuit**
 - Check for leaks inside the unit. In case a leak is detected, call your local dealer.
 - Check the working pressure of the unit. Refer to "Switching the unit on" on page 7.
- **Compressor**
 - Check on oil leaks. If there is an oil leak, call your local dealer.
 - Check for abnormal noises and vibrations. If the compressor is damaged, call your local dealer.
- **Fan motor**
 - Clean the cooling ribs of the motor.
 - Check on abnormal noises. If the fan or motor are damaged, call your local dealer.
- **Water supply**
 - Check if the water connection is still well fixed.
 - Check the water quality (refer to the installation manual of the unit for specifications of the water quality).
- **Water filters**
 - Make sure to clean the water filter in front of the evaporator water inlet once every 4 months.
 - Check the filter for any possible damage and make sure that the hole diameter size all over the filter surface is still 1.0 mm maximum.
- **Water sensors**
Check that all the water sensors are correctly fixed into the pipes in front of the heat exchanger (see also the sticker attached to the heat exchanger).

Disposal requirements

Dismantling of the unit, treatment of the refrigerant, of oil and of other parts must be done in accordance with relevant local and national legislation.

Thermostat parameters

Inlet water temperature control/Outlet water temperature control

The figure below shows the thermostat diagram.

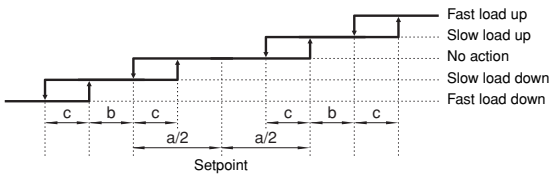

The default value and the upper and lower limits of the thermostat parameters are listed in the table below.

INLET CONTROL	Default value	Lower limit	Upper limit
Step difference - a	(K) 0.8 ^(a)	—	—
Step difference - b	(K) 0.5 ^(a)	—	—
Steplength - c	(K) 0.2 ^(a)	—	—
Loadup timer	(sec) 48	12	300
Loaddown timer	(sec) 24	12	300
Setpoint	(°C) 12.0	7.0	23.0

(a) can only be modified in the service menu

OUTLET CONTROL	Default value	Lower limit	Upper limit
Step difference - a	(K) 0.8 ^(a)	—	—
Step difference - b	(K) 0.5 ^(a)	—	—
Steplength - c	(K) 0.2 ^(a)	—	—
Loadup timer	(sec) 12	12	300
Loaddown timer	(sec) 12	12	300
Setpoint	(°C) 7.0	4.0	16.0

(a) can only be modified in the service menu

- If the temperature is below the setpoint, the thermostat control will check every LOADDOWN TIMER. According to the deviation to the setpoint, no action, slow load down (=−3%) or fast load down (=−7%) is required.
- If the temperature is above the setpoint, the thermostat control will check every LOADUP TIMER. According to the deviation to the setpoint, no action, slow load up (=+3%) or fast load up (=+7%) is required.

Schedule timer example

MARCH						
MON	TUE	WED	THU	FRI	SAT	SUN
1 G1	2 G1	3 G2	4 G1	5 G1	6 G3	7 G3
8 G1	9 G1	10 G2	11 G1	12 G1	13 G3	14 G3
15 G1	16 G1	17 G2	18 G1	19 G1	20 G3	21 G3
22 G1	23 H	24 H	25 H	26 H	27 H	28 H
29 H	30 G1	31 G2				

To come to the schedule above following settings have to be made:

```

-- SCHEDULE TIMER
MON:G1 THU:G1 SAT:G3
TUE:G1 FRI:G1 SUN:G3
WED:G2
    
```

⋮

```

--HD PERIOD:01 TO 03
01:23/03 TO 29/03
02:00/00 TO 00/00
03:00/00 TO 00/00
    
```

All days assigned to the same group will work according to the settings of this group.

In this example setting:

- all Mondays, Tuesdays, Thursdays and Fridays will work according to the settings in group 1 (G1),
- all Wednesdays will work according to the settings in group 2 (G2),
- all Saturdays and Sundays will work according to the settings in group 3 (G3),
- all holiday days will work according to the settings in the holiday group (H).

All group settings of groups G1, G2, G3, G4 and H work similar as following example (settings for group 1):

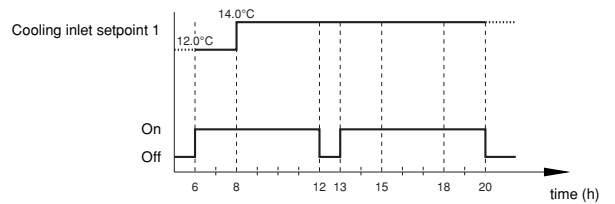

```

-- GROUP1:01 TO 03
1:06h00 ISP1 E: 12.0
2:06h00 ON 00.0
3:08h00 ISP1 E: 14.0
    
```

Screen 1

⋮

```

-- GROUP1:04 TO 06
4:12h00 OFF 00.0
5:13h00 ON 00.0
6:20h00 OFF 00.0
    
```

Screen 2

ANNEX III

Floating setpoint working

The diagram and table below show the default value and the upper and lower limits of the floating setpoint parameters on the evaporator.

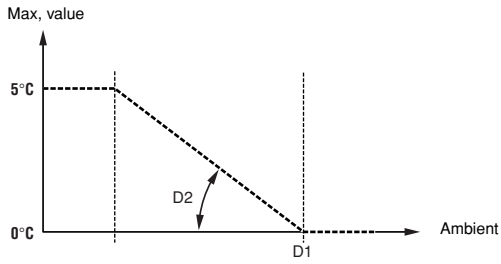

Floating setpoint	Default value	Lower limit	Upper limit
Maximum value (°C)	3.0	0.0	5.0
D1 (°C)	20.0	20.0	43.0
D2 ^(a) (°C)	5.0	0.0	10.0

(a) rise in floating setpoint value for 10°C drop in ambient

ANNEX IV

Free cooling working

Free cooling on ambient temperature

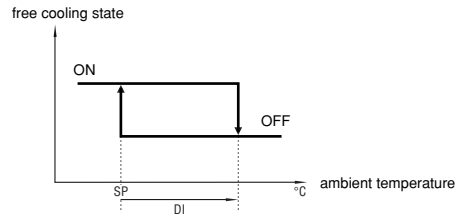

Free cooling	default	minimum	maximum
SP (°C)	5	-30	25
DI (°C)	2	1	5

Free cooling on difference between inlet water evaporator temperature and ambient temperature

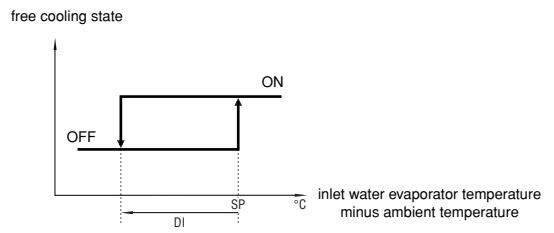

Free cooling	default	minimum	maximum
SP (°C)	5	1	20
DI (°C)	2	1	5

ANNEX V - SOFTWARE STRUCTURE

