

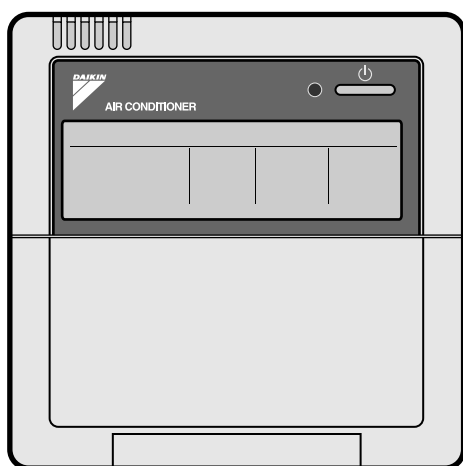

OPERATION MANUAL

VRV II Outdoor - Air Processing Unit



FXMQ125MFV1
FXMQ200MFV1
FXMQ250MFV1

Operation manual
VRV II Outdoor-air processing unit

English

Betriebsanweisung
VRV II Lüftungseinheit

Deutsch

Manuel d'utilisation
Unité de renouvellement d'air VRV II

Français

Manual de operación
Unidad de renovación del aire VRV II

Español

Manuale d'uso
Unità per ventilare la stanza VRV II

Italiano

Εγχειρίδιο λειτουργίας
Μονάδα αλλαγής αέρα VRV II

Ελληνικά

Gebbruiksaanwijzing
VRV II Ventilatieunit

Nederlands

Manual de funcionamento
VRV II Unidade de Mudança de Ar

Portugues

Руководство по эксплуатации
Блок воздухообмена VRV II

Русский

使用说明书
VRV II 室外空气处理装置

中文
(简体)

Thank you for purchasing Daikin products. Carefully read this operation manual before using the unit. It will tell you how to use the unit properly and help you if any trouble occurs. After reading the manual, file it away for future reference.

Danke, dass Sie sich für ein Produkt von Daikin entschieden haben. Lesen Sie dieses Bedienungsanleitung sorgfältig, ehe Sie das Klimagerät in Betrieb nehmen. Hier erfahren Sie, wie Sie das Gerät korrekt betreiben. Zudem hilft sie Ihnen, falls Störungen auftreten sollten. Bewahren Sie die Anweisung gut auf, wenn Sie sie durchgelesen haben, damit Sie auch später noch darin nachschlagen können.

Nous vous remercions pour avoir choisi les produits Daikin. Lisez attentivement ce manuel d'utilisation avant d'utiliser l'unité. Il vous enseignera à utiliser correctement l'unité et vous aidera en cas de panne. Après avoir lu le manuel, rangez-le en vue d'une utilisation ultérieure.

Muchas gracias por comprar productos Daikin. Lea este manual de uso atentamente antes de utilizar la unidad. El manual explica cómo usar la unidad correctamente y lo ayuda en caso de que surjan problemas. Después de leerlo, guárdelo para referencia futura.

Grazie di aver acquistato i prodotti Daikin. Prima di usare l'unità, leggere con attenzione questo manuale di istruzioni. Che illustra le modalità di utilizzo corretto e fornisce un supporto nell'eventualità di problemi di funzionamento. Dopo averlo letto, conservare il presente manuale per potervi fare riferimento in seguito.

Σας ευχαριστούμε που αγοράσατε προϊόντα Daikin. Πριν χρησιμοποιήσετε τη μονάδα διαβάστε προσεκτικά το παρόν εγχειρίδιο λειτουργίας. Σας δείχνει τον κατάλληλο τρόπο χειρισμού της μονάδας και τον τρόπο αντιμετώπισης ενδεχομένων προβλημάτων. Αφού διαβάσετε το εγχειρίδιο φυλάξτε το για μελλοντική αναφορά.

Hartelijk dank voor uw keuze voor de producten van Daikin. Lees deze bedieningshandleiding voordat u het apparaat gaat gebruiken. In de gebruiksaanwijzing kunt u lezen hoe u het apparaat op de juiste manier gebruikt en wat u kunt doen bij storingen. Bewaar deze gebruiksaanwijzing nadat u deze heeft gelezen.

Agradecemos a preferência pelos produtos Daikin. Antes de utilizar a unidade, leia atentamente o presente manual. Nele obterá informações sobre o modo de utilizar corretamente o aparelho e ajuda na eventualidade de ocorrência de problemas. Depois de ler o manual, guarde-o para consultas futuras.

Спасибо за покупку изделий Daikin. До начала работы с устройством внимательно изучите данное руководство по эксплуатации. В нем излагаются правила надлежащего пользования устройством и приводятся рекомендации пользователю по поиску и устранению неисправностей. После изучения руководства сохраните его для обращений в будущем.

感谢您购买大金空调产品。使用前，请仔细阅读此使用说明书。它将告诉您如何正确使用本装置，并能在出现问题时帮助您。用后请妥善保存，以便日后查阅。

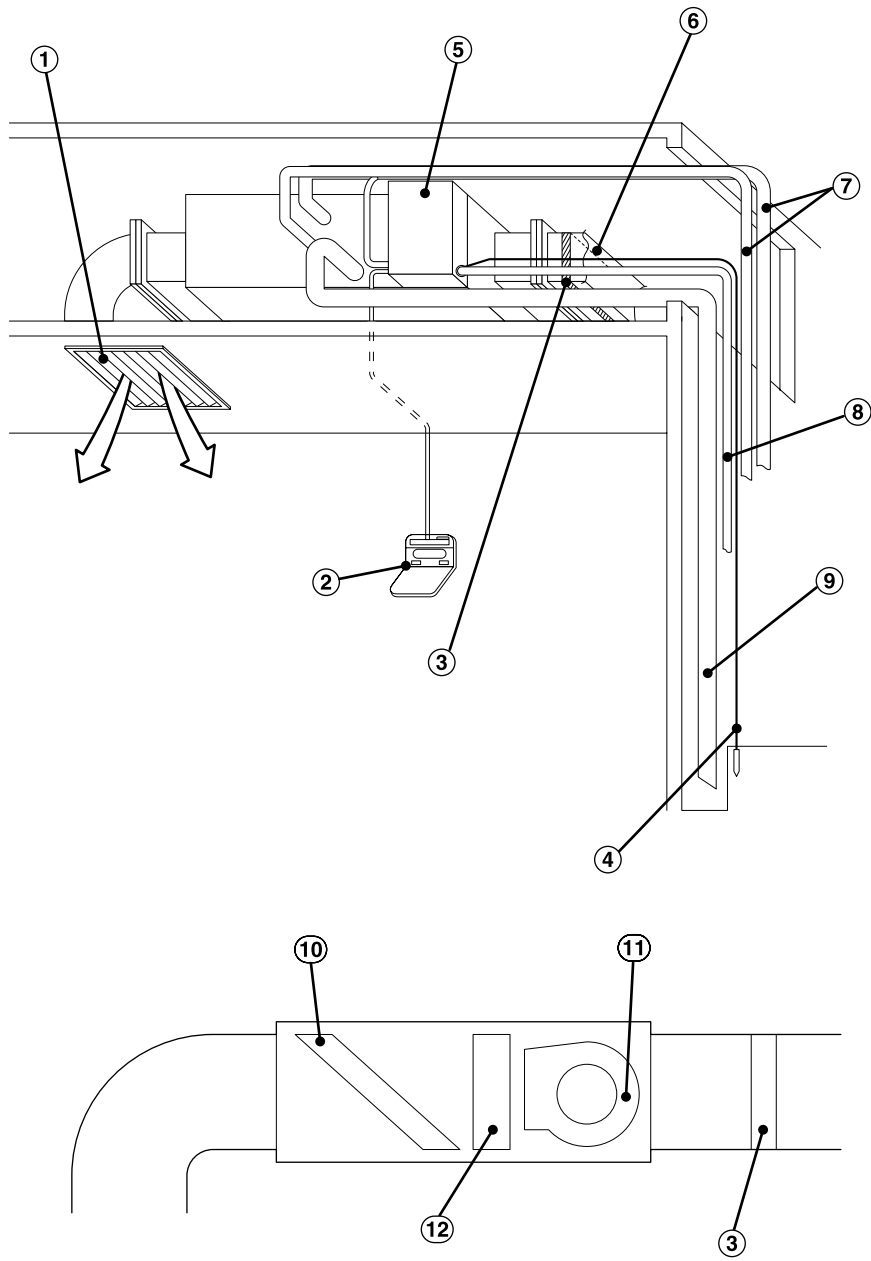

1

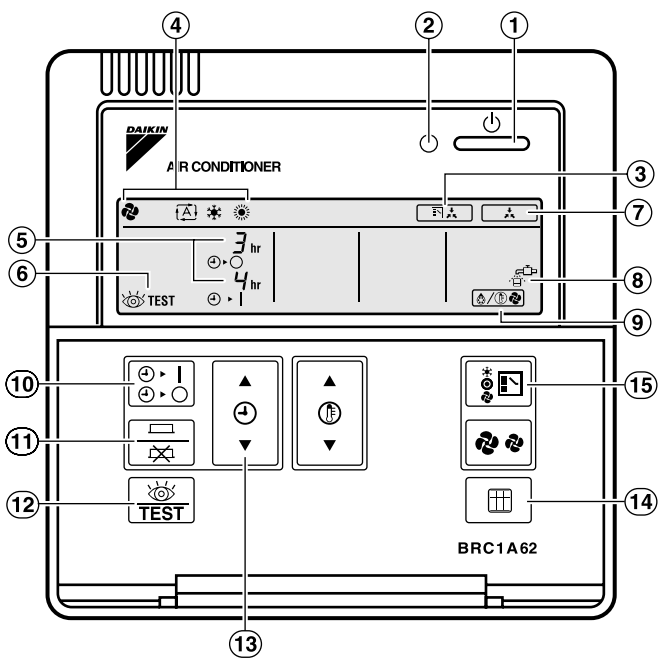

2

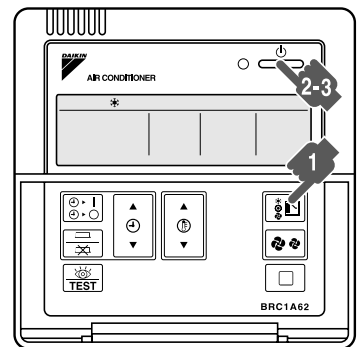

3

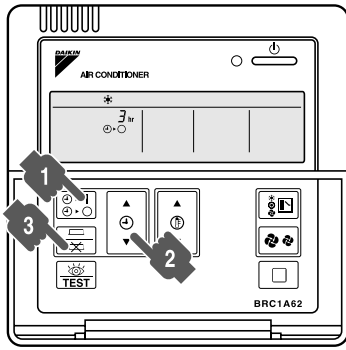

4

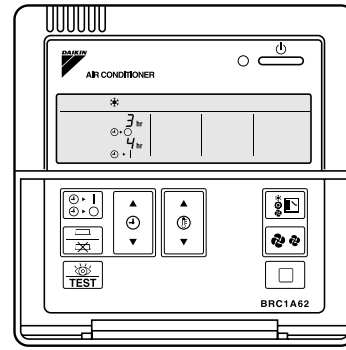

5

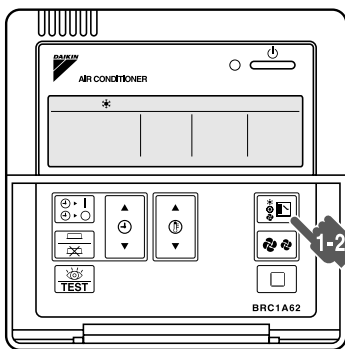

6

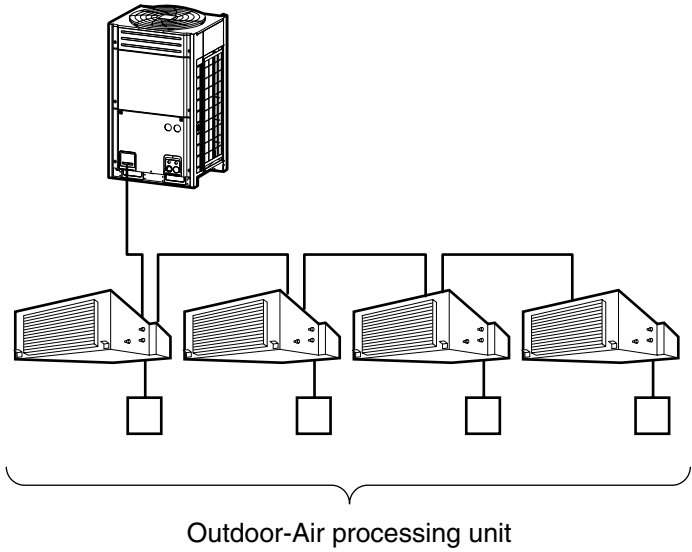

7

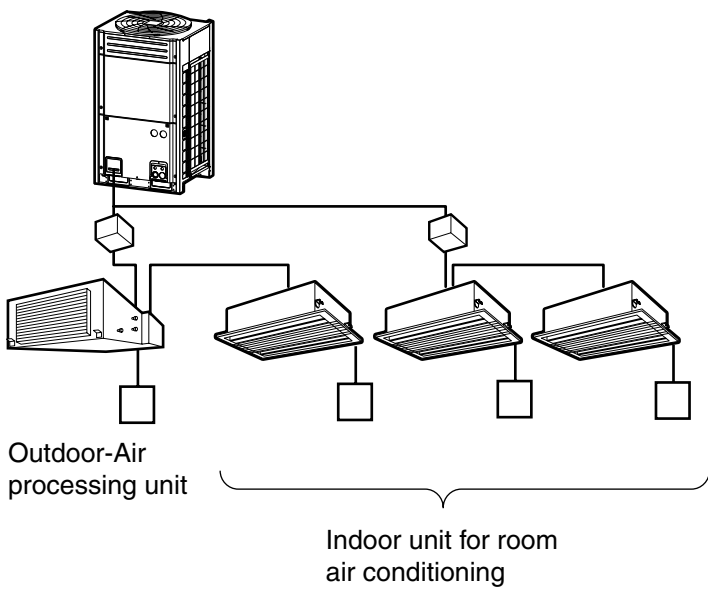

8

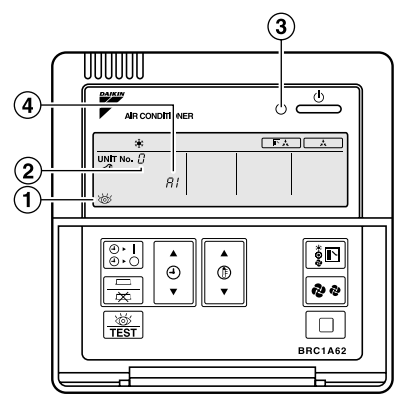

9

CONTENTS

1. SAFETY CAUTIONS.....	1
2. OUTDOOR-AIR PROCESSING UNIT :	
NAME OF EACH PART	3
3. REMOTE CONTROLLER :	
NAME AND FUNCTION OF EACH SWITCH	
AND DISPLAY	3
4. OPERATION RANGE.....	3
5. OPERATION PROCEDURE	4
6. OPTIMUM OPERATION	5
7. MAINTENANCE	6
8. FOLLOWING SYMPTOMS ARE NOT SYSTEM	
TROUBLES.....	6
9. TROUBLE SHOOTING	8

1. SAFETY CAUTIONS

Read the following cautions carefully and use your equipment properly.

There are three kinds of safety cautions and tips listed here as follows:

 **WARNING** Improper handling can lead to such serious consequences as death or serious injury.

 **CAUTION** Improper handling can lead to injury or damage. It could also have serious consequences under certain conditions.

NOTE  These instructions will ensure proper use of the equipment.

Be sure to follow these important safety cautions.

Keep this operation manual handy so that you can refer to it if needed.

Also, if this equipment is transferred to a new user, make sure to hand over this operation manual to the new user.

 **WARNING** _____

It is not good for your health to expose your body to the air flow for a long time.

In order to avoid electric shock, fire or injury, or if you detect any abnormality such as smell of fire, turn off the power supply and call your dealer for instructions.

Ask your dealer for installation of the unit.
Incomplete installation performed by yourself may result in a water leakage, electric shock, and fire.

Ask your dealer for improvement, repair, and maintenance.

Incomplete improvement, repair, and maintenance may result in a water leakage, electric shock, and fire.

Do not put a finger, a rod or other objects into the air inlet or outlet. As the fan is rotating at high speed, it will cause injury.

The refrigerant in the system is safe and normally does not leak. If the refrigerant leaks inside the room, the contact with a fire of a burner, a heater or a cooker may result in a harmful gas.
Do not use the system until when a service person confirms to finish repairing the portion where the refrigerant leaks.

For refrigerant leakage, consult your dealer.
When the unit is to be installed in a small room, it is necessary to take proper measures so that the amount of any leaked refrigerant does not exceed the limiting concentration even when it leaks. If the refrigerant leaks exceeding the level of limiting concentration, an oxygen deficiency accident may happen.

Improper installation or attachment of equipment or accessories could result in electric shock, short-circuit, leaks, fire or other damage to the equipment. Be sure only to use accessories made by Daikin which are specifically designed for use with the equipment and have them installed by a professional.

Ask your dealer to move and reinstall the unit.
Incomplete installation may result in a water leakage, electric shock, and fire.

In order to avoid electric shock, fire, injury or damaging the unit, do not use improper ampere fuses or do not use copper nor steel wires instead.

Be sure to establish an earth.
Do not earth the unit to a utility pipe, arrester, or telephone earth.

Incomplete earth may cause electrical shock, or fire. A high surge current from lightning or other sources may cause damage to the air conditioner.

Be sure to install an earth leakage breaker.
Failure to install an earth leakage breaker may result in electric shocks, or fire.

 **CAUTION** _____

Do not use the system for other purposes.
In order to avoid any quality deterioration, do not use the unit for cooling precision instruments, food, plants, animals or works of art.

Never remove the fan guard of the outdoor unit.
A fan rotating at high speed without the fan guard is very dangerous.

To avoid oxygen deficiency, ventilate the room sufficiently if equipment with burner is used together with the air conditioner.

After a long use, check the unit stand and fittings for damage.

If they are left in a damaged condition, the unit may fall and result in injury.

Never use combustible spray such as hair spray, lacquer or paint near the unit.

It may cause a fire.

Before cleaning, be sure to stop the operation, turn the breaker off.

Otherwise, an electric shock and injury may result.

Do not operate the system with a wet hand.

An electric shock may result.

Do not place items which might be damaged by moisture under the indoor unit which may be damaged by water.

Condensation may form if the humidity is above 80%, if the drain outlet gets blocked or the filter is polluted.

Do not place appliances which produce open fire in places exposed to the air flow from the unit or under the unit. It may cause incomplete combustion or deformation of the unit due to the heat.

Do not allow a child to mount on the outdoor unit or avoid placing any object on it.

Falling or tumbling may result in injury.

Never expose little children, plants or animals directly to the air flow.

Adverse influence to little children, plants or animals may result.

Do not wash the system with excessive water.

Electric shock or fire may result.

Do not install the unit at any place where combustible gas may leak out.

If the gas leaks out and stays around the unit, a fire may break out.

Arrange the drain hose to ensure smooth drainage. Incomplete drainage may cause wetting of the building, furniture etc.

Do not let children play on and around the outdoor unit.

If they touch the unit carelessly, it may result in injury.

Do not place a flower vase and anything containing water on the unit.

Water may enter the unit, causing an electric shock or fire.

Do not place the remote controller exposed to direct sunlight.

The LCD display may get discoloured, failing to display the data.

Do not wipe the remote controller operation panel with benzine, thinner, chemical dust-cloth, etc.

The panel may get discoloured or the coating peeled off. If it is heavily dirty, soak a cloth in water-diluted neutral detergent, squeeze it well and wipe the panel clean. And wipe it with another dry cloth.

Never touch the internal parts of the remote controller.

Do not remove the front panel. Some parts inside are dangerous to touch, and a machine trouble may happen. For checking and adjusting the internal parts, contact your dealer.

Never let the indoor unit or the remote controller get wet.

Do not wash the outdoor unit with water.

It may cause an electric shock or a fire.

Never press the button of the remote controller with a hard, pointed object.

The remote controller may be damaged.

Never pull or twist the electric wire of a remote controller.

It may cause the unit to malfunction.

Do not operate the unit when using a room fumigation - type insecticide.

Failure to observe could cause the chemicals to become deposited in the unit, which could endanger the health of those who are hypersensitive to chemicals.

Never put any objects into the air inlet or outlet.

Objects touching the fan at high operating speed can be dangerous.

Never inspect or service the unit by yourself.

Ask a qualified service person to perform this work.

The appliance is not intended for use by young children or infirm persons without supervision.

Young children should be supervised to ensure that they do not play with the appliance.

Consult with installation contractor for cleaning the inside of the air conditioner.

Wrong cleaning may make the plastics parts broken or cause failure of water leakage or electric shock.

Do not touch the air inlet or aluminium fin of the air conditioner.

Otherwise, injury may be caused.







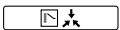

Do not place objects in direct proximity of the outdoor unit and do not let leaves and other debris accumulate around the unit.

Leaves are a hotbed for small animals which can enter the unit. Once in the unit, such animals can cause malfunctions, smoke or fire when making contact with electrical parts.

2. OUTDOOR-AIR PROCESSING UNIT : NAME OF EACH PART (Refer to figure 1)

1. Air outlet
2. Remote controller
3. Air filter (Optional accessory)
4. Ground wire
5. Electric parts box
6. Outdoor air inlet
7. Refrigerant pipe and interconnecting wire
8. Power wire
9. Drain pipe
10. Heat exchanger
11. Fan
12. Drain pump kit (Optional accessory)

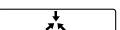
3. REMOTE CONTROLLER : NAME AND FUNCTION OF EACH SWITCH AND DISPLAY (Refer to figure 2)

1. **On/off button**
Press the button and the system will start. Press the button again and the system will stop.
2. **Operation lamp (red)**
The lamp lights up during operation.
3. **Display “” (changeover under control)**
It is impossible to change heat/cool with the remote controller when this icon is displayed.
4. **Display “” “” “” “” (operation mode)**
This display shows the current operation mode.
5. **Display “” (programmed time)**
This display shows the programmed time of the system start or stop.
6. **Display “ TEST” (inspection/test operation)**
When the inspection/test operation button is pressed, the display shows the mode in which the system actually is.
7. **Display “” (under centralized control)**
When this display shows, the system is under centralized control.
(This is not a standard specification.)
8. **Display “” (time to clean air filter)**
When this display shows, it is the time to clean air filter.
(The air filter is an optional accessory.)

9. **Display “” (defrost/hot start)**
Refer to the chapter “OPERATION PROCEDURE - EXPLANATION OF HEATING OPERATION.”
10. **Timer mode start/stop button**
Refer to the chapter “OPERATION PROCEDURE - PROGRAMMING START AND STOP OF THE SYSTEM WITH TIMER.”
11. **Timer on/off button**
Refer to the chapter “OPERATION PROCEDURE - PROGRAMMING START AND STOP OF THE SYSTEM WITH TIMER.”
12. **Inspection/test operation button**
This button is only used by qualified service persons for maintenance purposes.
13. **Programming time button**
Use this button for programming start and/or stop time.
14. **Filter sign reset button**
Refer to the chapter “MAINTENANCE”.
15. **Operation mode selector button**
Press this button to select the operation mode of your preference.

NOTE

- In contradistinction to actual operating situations, the display on figure 2 shows all possible indications.
- If the display “” (time to clean air filter) shows, clean the air filter as explained in the chapter “MAINTENANCE”. After cleaning and reinstalling the air filter, press the filter sign reset button on the remote controller. The filter sign lamp on the display will go out.
- This operation manual is for the Outdoor-Air Processing Unit.
See the outdoor unit’s operation manual for details on the indoor unit for room air conditioning.

4. OPERATION RANGE

Use the system in the following temperature and humidity ranges for safe and effective operation.

COOLING [°C]

OUTDOOR TEMPERATURE		
	TEMPERATURE	HUMIDITY
D B	19 to 43 (Note)	30% to 90%
W B	32 or below	(Long time operation in a humidity over 90% may cause condensation on the unit and dripping.)

DB: Dry bulb temperature
WB: Wet bulb temperature

NOTE

- The FAN OPERATION mode is set automatically for DB temperature of 19°C and below.

- Do not use the COOLING OPERATION or FAN OPERATION modes when outdoor temperature is 5°C or lower. The unit will stop running to protect itself against cold damage. In such case, set the AUTOMATIC OPERATION or HEATING OPERATION mode.

HEATING [°C]

OUTDOOR TEMPERATURE	
D	-5 to 15
B	(Note)

DB: Dry bulb temperature

NOTE

- The FAN OPERATION mode is set automatically for DB temperature of 15°C and above.

If the temperature or the humidity is beyond these conditions, safety devices may work and the unit may not operate.



5. OPERATION PROCEDURE

- To protect the unit, turn on the power supply 6 hours before operation.
- If the power supply is turned off during operation, operation will restart automatically after the power turns back on again.
- This unit cannot control room temperature. If room temperature control is needed, install it together with the indoor unit for room air conditioning.
- This unit is designed to operate so that the temperature of the outlet air is as close as possible to the set temperature.

This may not be possible, however, due to the outdoor air temperature.

When shipped from the factory, the set temperature is set at 18°C for cooling and 25°C for heating. The set temperature can be changed between 13 and 25°C for cooling / 18 and 30°C for heating by local setting from remote controller. About set temperature or how to change it, ask your dealer. The set temperature will not be displayed on the remote controller.

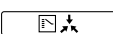



5-1 COOLING, HEATING, AUTOMATIC, AND FAN ONLY OPERATION (Refer to figure 3)

- Changeover cannot be made with a remote controller whose display shows “” (changeover under control).
- When the display “” (changeover under control) flashes, refer to the chapter “5-3 SETTING THE MASTER REMOTE CONTROLLER”.
- The fan may keep on running for about 1 minute after the heating operation stops.

- The fan may stop immediately. This is not a malfunction.

Starting the system

- Press the operation mode selector button several times and select the operation mode of your choice;

- “” Cooling operation
- “” Heating operation
- “” Automatic operation
- “” Fan only operation

NOTE

- Cooling / Heating operation
Outdoor air is cooled or warmed and brought indoors.
- Automatic operation
In this operation mode, cool/heat changeover is automatically conducted.
- Fan only operation
Outdoor air is brought indoors as is.

- Press the on/off button.
The operation lamp lights up and the system starts operation.

Stopping the system

- Press the on/off button once again.
The operation lamp goes off and the system stops operation.

NOTE

- Do not turn off the power supply immediately after the unit stops, but wait for at least 5 minutes.

EXPLANATION OF HEATING OPERATION

Defrost operation

- In heating operation, freezing of the outdoor unit coil increases. Heating capability decreases and the system goes into defrost operation.
- The indoor unit fan stops and the remote controller displays “”.
- After maximum 12 minutes of defrost operation, the system returns to heating operation again.

Hot start

- In order to prevent cold air from blowing out of an indoor unit at the start of heating operation, the indoor fan is automatically stopped. The display of the remote controller shows “”.

5-2 PROGRAMMING START AND STOP OF THE SYSTEM WITH TIMER (Refer to figure 4)

- The timer is operated in the following two ways.
Programming the stop time “⏸▶○”: The system stops operating after the set time has elapsed.
Programming the start time “⏸▶|”: The system starts operating after the set time has elapsed.
- The timer can be programmed for a maximum of 72 hours.
- The start and the stop time can be simultaneously programmed.

1 Press the timer mode start/stop button several times and select the mode on the display. The display flashes.

- For setting the timer stop “⏸▶○”
- For setting the timer start “⏸▶|”

2 Press the programming time button and set the time for stopping or starting the system.

 Each time this button is pressed, the time advances or goes backward by 1 hour.

3 Press the timer on/off button. The timer setting procedure ends. The display “⏸▶○” or “⏸▶|” changes from flashing light to constant light.

NOTE

- When setting the timer stop and start at the same time, repeat the above procedure (from “**1**” to “**3**”) once again.
- After the timer is programmed, the display shows the remaining time.
- Press the timer on/off button once again to cancel programming. The display vanishes.

For example: (Refer to figure 5)

When the timer is programmed to stop the system after 3 hours and start the system after 4 hours, the system will stop after 3 hours and start 1 hour later.

5-3 SETTING THE MASTER REMOTE CONTROLLER (Refer to figure 6)



- When the system is installed as shown in figure 7 and 8, it is necessary to designate one of the remote controllers as the master remote controller.
- When one outdoor unit is connected with several outdoor-air processing units, designate one of the remote controllers as the master remote controller. (Refer to figure 7)
- When one outdoor unit is connected with outdoor-air processing units and indoor units for room air conditioning, designate one of the remote controllers of the indoor units as the master remote controller. (Refer to figure 8)

Otherwise, operation of system will be changed by outdoor air condition during automatic operation.

- Only the master remote controller can select heating, cooling or automatic (Only if the remote controller of outdoor air processing unit is designated as the master remote controller.) operation.
- The displays of slave remote controllers show “” (changeover under control) and they automatically follow the operation mode directed by the master remote controller.
- However, it is possible to change to fan only operation with slave remote controllers.

How to designate the master remote controller (Refer to figure 6)

1 Press the operation mode selector button of the current master remote controller for 4 seconds. The display showing “” (changeover under control) of all slave remote controllers connected to the same outdoor unit flashes.

2 Press the operation mode selector button of the controller that you wish to designate as the master remote controller. Then designation is completed. This remote controller is designated as the master remote controller and the display showing “” (changeover under control) vanishes. The displays of other remote controllers show “” (changeover under control).

5-4 PRECAUTIONS FOR GROUP CONTROL SYSTEM OR TWO REMOTE CONTROLLERS CONTROL SYSTEM

This system provides two other control systems beside individual control (one remote controller controls one indoor unit) system. Confirm the following if your unit is of the following control system type.

• Group control system

One remote controller controls up to 16 indoor units. All indoor units are equally set.

• Two remote controllers control system

Two remote controllers control one indoor unit (in case of group control system, one group of indoor units). The unit is individually operated.

NOTE

- Contact your Daikin dealer in case of changing the combination or setting of group control and two remote controllers control systems.

6. OPTIMUM OPERATION

Observe the following precautions to ensure the system operates properly.

- Adjust the air outlet properly and avoid direct air flow to room inhabitants.

- Adjust the room temperature properly for a comfortable environment. Avoid excessive heating or cooling.
- Prevent direct sunlight from entering a room during cooling operation by using curtains or blinds.
- Ventilate often.
Extended use requires special attention to ventilation.
- Keep doors and windows closed. If the doors and windows remain open, air will flow out of your room causing a decrease in the cooling or heating effect.
- Never place objects near the air inlet or the air outlet of the unit. It may cause deterioration in the effect or stop the operation.
- Turn off the power supply to the unit when the unit is not used for longer periods of time. If the switch is on, it uses electricity. Before restarting the unit, turn on the power supply 6 hours before operation to ensure smooth running. (Refer to the chapter "OPERATION PROCEDURE".)
- When the display shows "  " (time to clean the air filter), ask a qualified service person to clean the filters. (Refer to the chapter "MAINTENANCE".)
- Keep the indoor unit and remote controller at least 1 m away from televisions, radios, stereos, and other similar equipment.
Failing to do so may cause static or distorted pictures.

7. MAINTENANCE

WARNING

- ONLY A QUALIFIED SERVICE PERSON IS ALLOWED TO PERFORM MAINTENANCE.
- BEFORE OBTAINING ACCESS TO TERMINAL DEVICES, ALL POWER SUPPLY CIRCUITS MUST BE INTERRUPTED.
- DO NOT USE WATER OR AIR OF 50°C OR HIGHER FOR CLEANING AIR FILTERS.

7-1 HOW TO CLEAN THE AIR FILTER

(The air filter is an optional accessory.)

About DAIKIN long life replacement filter

Clean the air filter when the display shows "  " (time to clean air filter).

Increase the frequency of cleaning if the unit is installed in a room where the air is extremely contaminated.

(As a yardstick for regulating yourself, consider cleaning the filter.)

1. Remove the air filters.

2. Clean the air filter.

Use vacuum cleaner **A)** or wash the air filter with water **B)**.

A) Using a vacuum cleaner.



B) Washing with water.

To clean the air filter, use soft brush and neutral detergent.

Remove water and dry in the shade after cleaning.



3. Fix the air filter.

4. Press the **FILTER SIGN RESET** BUTTON on the remote controller.

The display "  " (time to clean air filter) vanishes.

About other air filter.

Clean the air filter by suitable method in the filter.

NOTE

- Do not remove the air filter except when cleaning. Unnecessary handling may damage the filter.

HOW TO CLEAN AIR OUTLET

1. Clean with soft cloth.

2. When it is difficult to remove stains, use water or neutral detergent.

NOTE

- Do not use gasoline, benzene, thinner, polishing powder, liquid insecticide. It may cause discolouring or warping.
- Do not let the unit get wet. It may cause an electric shock or a fire.

8. FOLLOWING SYMPTOMS ARE NOT SYSTEM TROUBLES

8-1 THE SYSTEM DOES NOT OPERATE

- **The system does not start immediately after the ON/OFF button on the remote controller is pushed.**

If the operation lamp lights, the system is in normal condition.

To prevent overloading of the compressor motor, the system starts 5 minutes after it is turned ON again in case it was turned OFF just before. The same starting delay occurs after the operation mode selector button was used.

- **If the display shows "  " (under centralized control) and pressing the operation button causes the display to blink for a few seconds.**

This indicates that the central device is controlling the unit.

The blinking display indicates that the remote controller cannot be used.

- **The system does not start immediately after the power supply is turned on.**
Wait one minute until the micro computer is prepared for operation.

8-2 COOL/HEAT CANNOT BE CHANGED OVER

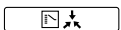
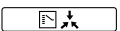
- **When the display shows “” (changeover under control), it shows that this is a slave remote controller.**
- **When the cool/heat changeover remote control switch is installed and the display shows “” (changeover under control).**
This is because cool/heat changeover is controlled by the cool/heat changeover remote control switch. Ask your Daikin dealer where the remote control switch is installed.

8-3 FAN OPERATION IS POSSIBLE, BUT COOLING AND HEATING DO NOT WORK

- **When the outdoor temperature exceeds the range of use conditions, the unit automatically changes into fan mode from cooling or heating modes.**

8-4 NO AIR COMES OUT

- **The outdoor temperature has dropped to 0°C or lower while in “cooling” or “fan” modes.**
The fan automatically stops due to the outdoor air temperature.

8-5 WHITE MIST COMES OUT OF A UNIT

Outdoor-air processing unit

- **When humidity is high during cooling operation.**
If the interior of the unit is extremely contaminated, the temperature distribution inside the unit becomes uneven. It is necessary to clean the interior of the unit. Ask your Daikin dealer for details on cleaning the unit. This operation requires a qualified service person.
- **Immediately after the cooling operation stops and if the outdoor temperature and humidity are low.**
This is because warm refrigerant gas flows back into the unit and generates steam.

Outdoor-air processing unit, outdoor unit

- **When the system is changed over to heating operation after defrost operation.**
Moisture generated by defrost becomes steam and is exhausted.

8-6 NOISE OF SYSTEM

Outdoor-air processing unit

- **A “zeen” sound is heard immediately after the power supply is turned on.**
The electronic expansion valve inside the unit starts working and makes the noise. Its volume will reduce in about one minute.
- **A continuous low “shah” sound is heard when the system is in cooling operation or at a stop.**
When the drain pump (optional accessories) is in operation, this noise is heard.
- **A “pishi-pishi” squeaking sound is heard when the system stops after heating operation.**
Expansion and contraction of plastic parts caused by temperature change make this noise.
- **A low “sah”, “choro-choro” sound is heard while the unit is stopped.**
When the other unit is in operation, this noise is heard. In order to prevent oil and refrigerant from remaining in the system, a small amount of refrigerant is kept flowing.

Outdoor-air processing unit, outdoor unit

- **A continuous low hissing sound is heard when the system is in cooling or defrost operation.**
This is the sound of refrigerant gas flowing through the system.
- **A hissing sound which is heard at the start or immediately after stopping operation or defrost operation.**
This is the noise of refrigerant caused by flow stop or flow change.

Outdoor unit

- **When the tone of operating noise changes.**
This noise is caused by the change of frequency.

8-7 DUST COMES OUT OF THE UNIT

- **When the unit is used after having stopped operating for a long time.**
This is because dust has gotten into the unit.

8-8 THE UNITS MAY GIVE OFF ODOURS

- **The unit may absorb the smell of outdoor air.**

8-9 THE OUTDOOR UNIT FAN DOES NOT SPIN

- **During operation.**
The speed of the fan is controlled in order to optimize product operation.

8-10 THE DISPLAY SHOWS “”

- **This is the case immediately after the power supply is turned on and means that the remote controller is in normal condition. This continues for one minute.**

8-11 THE COMPRESSOR IN THE OUTDOOR UNIT DOES NOT STOP AFTER A SHORT HEATING OPERATION

- This is to prevent oil and refrigerant from remaining in the compressor. The unit will stop after 5 to 10 minutes.

8-12 THE INSIDE OF AN OUTDOOR UNIT IS WARM EVEN WHEN THE UNIT HAS STOPPED

- This is because the crankcase heater is warming the compressor so that the compressor can start smoothly.

9. TROUBLE SHOOTING

If one of the following malfunctions occur, take the measures shown below and contact your Daikin dealer.

The system must be repaired by a qualified service person.

- If a safety device such as a fuse, a breaker or an earth leakage breaker frequently actuates, or the ON/OFF switch does not properly work;
Measure: Turn off the power supply.
- If water leaks from unit;
Measure: Stop the operation.
- If the display “ TEST”, the unit number and the operation lamp flash and the malfunction code appears; **(Refer to figure 9)**
 1. Inspection display
 2. Unit number in which a malfunction occurs
 3. Operation lamp
 4. Malfunction codeMeasure: Notify your Daikin dealer and report the malfunction code.

If the system does not properly operate except for the above mentioned cases and none of the above mentioned malfunctions is evident, investigate the system according to the following procedures.

1. If the system does not operate at all;
 - Check if there is no power failure.
Wait until power is restored. If power failure occurs during operation, the system automatically restarts immediately after the power supply is recovered.
 - Check if no fuse has blown or breaker has worked. Change the fuse or reset the breaker if necessary.
2. If the system goes into fan only operation, but as soon as it goes into heating or cooling operation, the system stops;
 - Check if air inlet or outlet of outdoor unit or outdoor-air processing unit is not blocked by obstacles.
Remove any obstacle and make it well-ventilated.

- Check if the remote controller display shows “” (time to clean the air filter). (Refer to the chapter “MAINTENANCE”).

3. The system operates but cooling or heating is insufficient;
 - Check if air inlet or outlet of outdoor or outdoor-air processing unit is not blocked by obstacles. Remove any obstacle and make it well-ventilated.
 - Check if the air filter is not clogged. (Refer to the chapter “MAINTENANCE”).

DAIKIN INDUSTRIES, LTD.

Head office:

Umeda Center Bldg., 2-4-12, Nakazaki-Nishi,
Kita-ku, Osaka, 530-8323 Japan

Tokyo office:

JR Shinagawa East Bldg., 2-18-1, Konan,
Minato-ku, Tokyo, 108-0075 Japan

DAIKIN EUROPE NV

Zandvoordestraat 300, B-8400 Oostende, Belgium