

DAIKIN

OPERATION MANUAL

VRV II Outdoor - Air Processing Unit

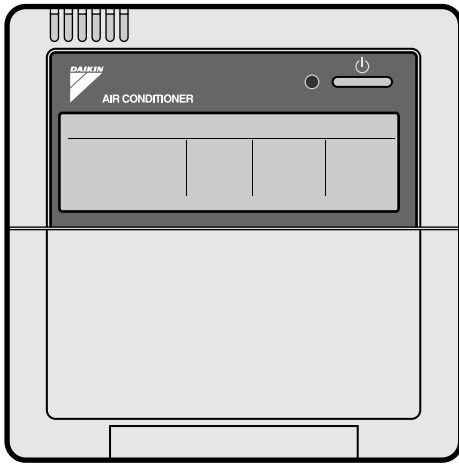

**FXMQ125MFV1
FXMQ200MFV1
FXMQ250MFV1
FXMQ125MFV7
FXMQ200MFV7
FXMQ250MFV7**

**Operation manual
VRVII Outdoor-air processing unit**

English

**Betriebsanweisung
VRVII Lüftungseinheit**

Deutsch

**Manuel d'utilisation
Unité de renouvellement d'air VRVII**

Français

**Manual de operación
Unidad de renovación del aire VRVII**

Español

**Manuale d'uso
Unità per ventilare la stanza VRVII**

Italiano

**Εγχειρίδιο λειτουργίας
Μονάδα αλλαγής αέρα VRVII**

Ελληνικά

**Gebruiksaanwijzing
VRVII Ventilatieunit**

Nederlands

**Manual de funcionamento
VRVII Unidade de Mudança de Ar**

Portugues

**Руководство по эксплуатации
Блок воздухообмена VRVII**

Русский

**使用说明书
VRVII室外空气处理装置**

中文
(简体)

Thank you for purchasing Daikin products. Carefully read this operation manual before using the unit. It will tell you how to use the unit properly and help you if any trouble occurs. After reading the manual, file it away for future reference.

Danke, dass Sie sich für ein Produkt von Daikin entschieden haben. Lesen Sie dieses Bedienungsanleitung sorgfältig, ehe Sie das Klimagerät in Betrieb nehmen. Hier erfahren Sie, wie Sie das Gerät korrekt betreiben. Zudem hilft sie Ihnen, falls Störungen auftreten sollten. Bewahren Sie die Anweisung gut auf, wenn Sie sie durchgelesen haben, damit Sie auch später noch darin nachschlagen können.

Nous vous remercions pour avoir choisi les produits Daikin. Lisez attentivement ce manuel d'utilisation avant d'utiliser l'unité. Il vous enseignera à utiliser correctement l'unité et vous aidera en cas de panne. Après avoir lu le manuel, rangez-le en vue d'une utilisation ultérieure.

Muchas gracias por comprar productos Daikin. Lea este manual de uso atentamente antes de utilizar la unidad. El manual explica cómo usar la unidad correctamente y lo ayuda en caso de que surjan problemas. Después de leerlo, guárdelo para referencia futura.

Grazie di aver acquistato i prodotti Daikin. Prima di usare l'unità, leggere con attenzione questo manuale di istruzioni. Che illustra le modalità di utilizzo corretto e fornisce un supporto nell'eventualità di problemi di funzionamento. Dopo averlo letto, conservare il presente manuale per potervi fare riferimento in seguito.

Σας ευχαριστούμε που αγοράσατε προϊόντα Daikin. Πριν χρησιμοποιήσετε τη μονάδα διαβάστε προσεκτικά το παρόν εγχειρίδιο λειτουργίας. Σας δείχνει τον κατάλληλο τρόπο χειρισμού της μονάδας και τον τρόπο αντιμετώπισης ενδεχομένων προβλημάτων. Αφού διαβάσετε το εγχειρίδιο φυλάξτε το για μελλοντική αναφορά.

Hartelijk dank voor uw keuze voor de producten van Daikin. Lees deze bedieningshandleiding voordat u het apparaat gaat gebruiken. In de gebruiksaanwijzing kunt u lezen hoe u het apparaat op de juiste manier gebruikt en wat u kunt doen bij storingen. Bewaar deze gebruiksaanwijzing nadat u deze heeft gelezen.

Agradecemos a preferência pelos produtos Daikin. Antes de utilizar a unidade, leia atentamente o presente manual. Nele obterá informações sobre o modo de utilizar corretamente o aparelho e ajuda na eventualidade de ocorrência de problemas. Depois de ler o manual, guarde-o para consultas futuras.

Спасибо за покупку изделий Daikin. До начала работы с устройством внимательно изучите данное руководство по эксплуатации. В нем излагаются правила надлежащего пользования устройством и приводятся рекомендации пользователю по поиску и устранению неисправностей. После изучения руководства сохраните его для обращений в будущем.

感谢您购买大金空调产品。使用前，请仔细阅读此使用说明书。它将告诉您如何正确使用本装置，并能在出现问题时帮助您。用后请妥善保存，以便日后查阅。

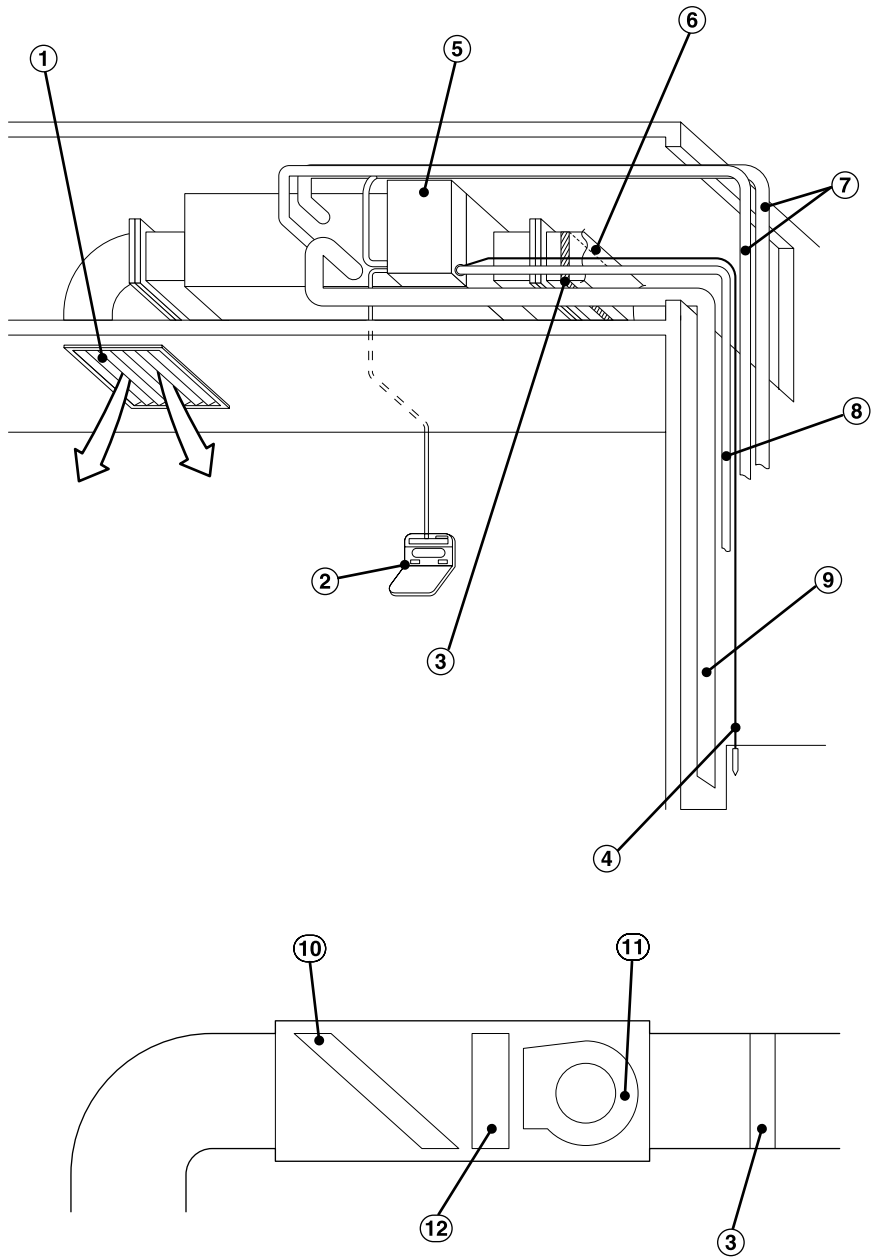

1

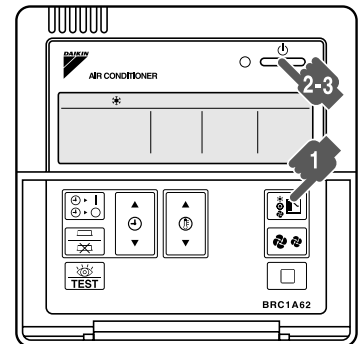
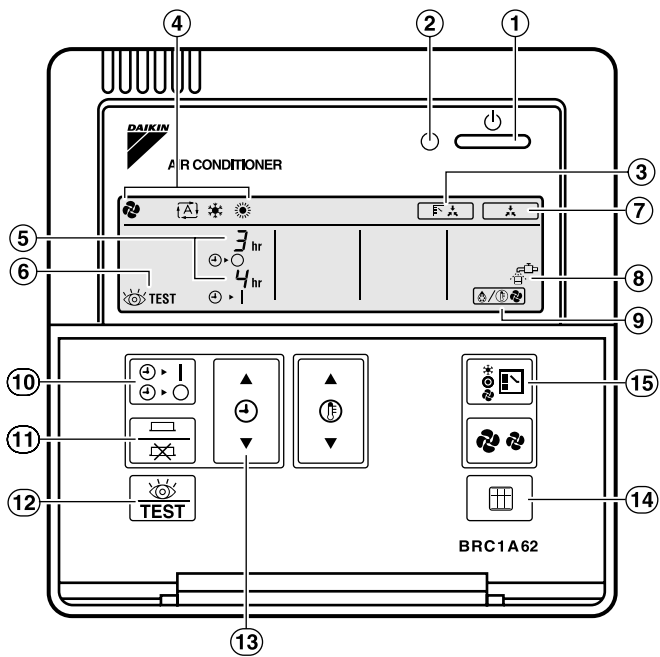

2

3

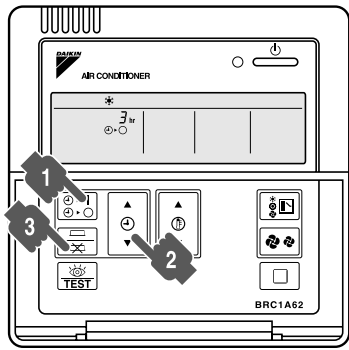

4

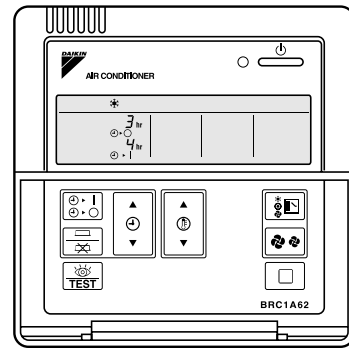

5

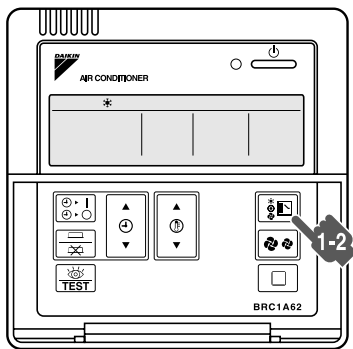

6

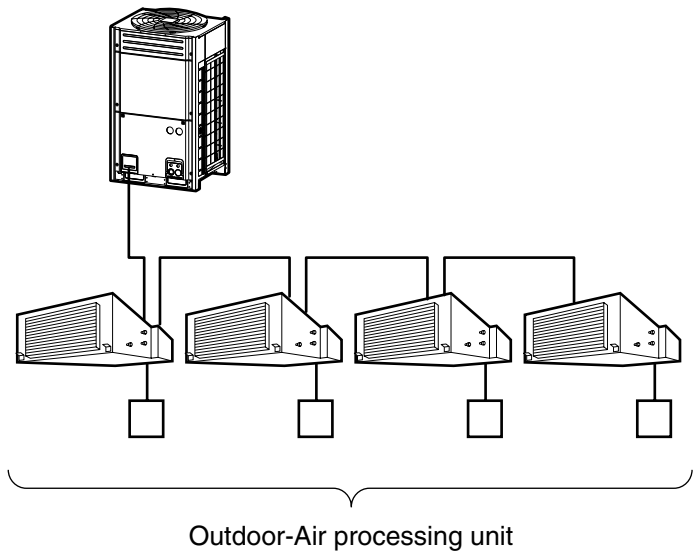

7

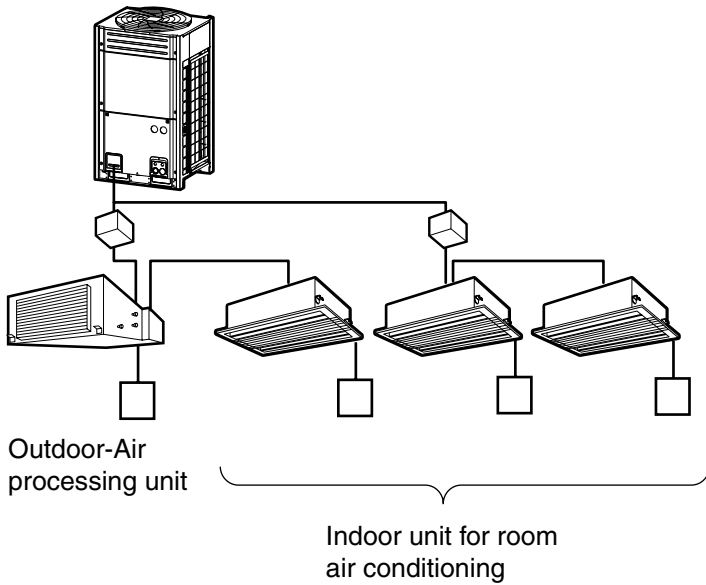

8

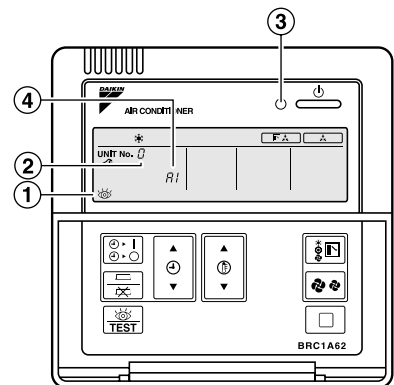

9

CONTENTS

1. SAFETY PRECAUTIONS	1
2. OUTDOOR-AIR PROCESSING UNIT : NAME OF EACH PART	3
3. REMOTE CONTROLLER : NAME AND FUNCTION OF EACH SWITCH AND DISPLAY.....	3
4. OPERATION RANGE.....	4
5. OPERATION PROCEDURE	4
6. OPTIMUM OPERATION	6
7. MAINTENANCE.....	7
8. FOLLOWING SYMPTOMS ARE NOT SYSTEM TROUBLES.....	7
9. TROUBLE SHOOTING	9

Important information regarding the refrigerant used

This product contains fluorinated greenhouse gases covered by the Kyoto Protocol.

Refrigerant type : R410A

GWP⁽¹⁾ value : 1975

⁽¹⁾GWP = global warming potential

Periodical inspections for refrigerant leaks may be required depending on European or local legislation.

Please contact your local dealer for more information.

1. SAFETY PRECAUTIONS

To gain full advantage of the air conditioner's functions and to avoid malfunction due to mishandling, we recommend that you read this instruction manual carefully before use.

This air conditioner is classified under "appliances not accessible to the general public".

- **The precautions described herein are classified as WARNING and CAUTION. They both contain important information regarding safety. Be sure to observe all precautions without fail.**

 **WARNING** Failure to follow these instructions properly may result in personal injury or loss of life.

 **CAUTION** Failure to observe these instructions properly may result in property damage or personal injury, which may be serious depending on the circumstances.

- **After reading, keep this manual in a convenient place so that you can refer to it whenever necessary. If the equipment is transferred to a new user, be sure also to hand over the manual.**

WARNING

Be aware that prolonged, direct exposure to cool or warm air from the air conditioner, or to air that is too cool or too warm can be harmful to your physical condition and health.

When the air conditioner is malfunctioning (giving off a burning odour, etc.) turn off power to the unit and contact your local dealer.

Continued operation under such circumstances may result in a failure, electric shocks or fire hazards.

Consult your local dealer about installation work.

Doing the work yourself may result in water leakage, electric shocks or fire hazards.

Consult your local dealer regarding modification, repair and maintenance of the air conditioner.

Improper workmanship may result in water leakage, electric shocks or fire hazards.

Do not place objects, including rods, your fingers, etc., in the air inlet or outlet.

Injury may result due to contact with the air conditioner's highspeed fan blades.

Beware of fire in case of refrigerant leakage.

If the air conditioner is not operating correctly, i.e. not generating cool or warm air, refrigerant leakage could be the cause.

Consult your dealer for assistance.

The refrigerant within the air conditioner is safe and normally does not leak.

However, in the event of a leakage, contact with a naked burner, heater or cooker may result in generation of noxious gas.

Do not longer use the air conditioner until a qualified service person confirms that the leakage has been repaired.

Consult your local dealer regarding what to do in case of refrigerant leakage.

When the air conditioner is to be installed in a small room, it is necessary to take proper measures so that the amount of any leaked refrigerant does not exceed the concentration limit in the event of a leakage. Otherwise, this may lead to an accident due to oxygen depletion.

Contact professional personnel about attachment of accessories and be sure to use only accessories specified by the manufacturer.

If a defect results from your own workmanship, it may result in water leaks, electric shock or fire.

Consult your local dealer regarding relocation and reinstallation of the air conditioner.

Improper installation work may result in leakage, electric shocks or fire hazards.

Be sure to use fuses with the correct ampere reading.

Do not use improper fuses, copper or other wires as a substitute, as this may result in electric shock, fire, injury or damage to the unit.

Be sure to earth the unit.

Do not earth the unit to a utility pipe, lightning conductor or telephone earth lead. Imperfect earthing may result in electric shocks or fire. A high surge current from lightning or other sources may cause damage to the air conditioner.

Be sure to install an earth leakage breaker.

Failure to install an earth leakage breaker may result in electric shocks or fire.

Consult the dealer if the air conditioner submerges owing to a natural disaster, such as a flood or typhoon.

Do not operate the air conditioner in that case, or otherwise a malfunction, electric shock, or fire may result.

Do not start or stop operating the air conditioner with the power supply breaker turned ON or OFF.

Otherwise, fire or water leakage may result. Furthermore, the fan will rotate abruptly if power failure compensation is enabled, which may result in injury.

Do not use the product in the atmosphere contaminated with oil vapor, such as cooking oil or machine oil vapor.

Oil vapor may cause crack damage, electric shocks, or fire.

Do not use the product in places with excessive oily smoke, such as cooking rooms, or in places with flammable gas, corrosive gas, or metal dust.

Using the product in such places may cause fire or product failures.

Do not use flammable materials (e.g., hairspray or insecticide) near the product.

Do not clean the product with organic solvents such as paint thinner.

The use of organic solvents may cause crack damage to the product, electric shocks, or fire.

Be sure to use a dedicated power supply for the air conditioner.

The use of any other power supply may cause heat generation, fire, or product failures.

Consult your dealer regarding cleaning the inside of the air conditioner.

Improper cleaning may cause breakage of plastic parts, water leakage and other damage as well as electric shocks.

 **CAUTION**

Do not use the air conditioner for purposes other than those for which it is intended.

Do not use the air conditioner for cooling precision instruments, food, plants, animals or works of art as this may adversely affect the performance, quality and/or longevity of the object concerned.

Do not remove the outdoor unit's fan guard.

The guard protects against the unit's high speed fan, which may cause injury.

Do not place objects that are susceptible to moisture directly beneath the indoor or outdoor units.

Under certain conditions, condensation on the main unit or refrigerant pipes, air filter dirt or drain blockage may cause dripping, resulting in fouling or failure of the object concerned.

To avoid oxygen depletion, ensure that the room is adequately ventilated if equipment such as a burner is used together with the air conditioner.

After prolonged use, check the unit stand and its mounts for damage.

If left in a damaged condition, the unit may fall and cause injury.

Do not place flammable sprays or operate spray containers near the unit as this may result in fire.

Before cleaning, be sure to stop unit operation, turn the breaker off or remove the power cord.

Otherwise, an electric shock and injury may result.

To avoid electric shocks, do not operate with wet hands.

Do not place appliances that produce naked flames in places exposed to the air flow from the unit as this may impair combustion of the burner.

Do not place heaters directly below the unit, as resulting heat can cause deformation.

Do not allow a child to mount on the outdoor unit or avoid placing any object on it.

Falling or tumbling may result in injury.

Do not place the controller exposed to direct sunlight.

The LCD display may get discolored, failing to display the data.

Do not wipe the controller operation panel with benzine, thinner, chemical dustcloth, etc.

The panel may get discolored or the coating peeled off. If it is heavily dirty, soak a cloth in water-diluted neutral detergent, squeeze it well and wipe the panel clean. And wipe it with another dry cloth.

Do not block air inlets nor outlets.

Impaired air flow may result in insufficient performance or trouble.

Be sure that children, plants or animals are not exposed directly to airflow from the unit, as adverse effects may ensue.

Do not wash the air conditioner or the remote controller with water, as this may result in electric shocks or fire.

Do not install the air conditioner at any place where there is a danger of flammable gas leakage.

In the event of a gas leakage, build-up of gas near the air conditioner may result in fire hazards.

Do not put flammable containers, such as spray cans, within 1 m from the blow-off mouth.

The containers may explode because the warm air output of the indoor or outdoor unit will affect them.

Arrange the drain to ensure complete drainage.

If proper drainage from the outdoor drain pipe does not occur during air conditioner operation, there could be a blockage due to dirt and debris build-up in the pipe.

This may result in a water leakage from the indoor unit. Under these circumstances, stop air conditioner operation and consult your dealer for assistance.

The appliance is not intended for use by unattended young children or infirm persons.

Impairment of bodily functions and harm to health may result.

Children should be supervised to ensure that they do not play with the unit or its remote controller.

Accidental operation by a child may result in impairment of bodily functions and harm health.

Do not let children play on or around the outdoor unit.

If they touch the unit carelessly, injury may be caused.

Do not place water containers (flower vases, etc.) on the unit, as this may result in electric shocks or fire.

To avoid injury, do not touch the air inlet or aluminium fins of the unit.

Never press the button of the remote controller with a hard, pointed object.

The remote controller may be damaged.

Never pull or twist the electric wire of a remote controller.

It may cause the unit to malfunction.

Do not operate the air conditioner when using a room fumigation - type insecticide.

Failure to observe could cause the chemicals to become deposited in the unit, which could endanger the health of those who are hypersensitive to chemicals.

Do not place objects in direct proximity of the outdoor unit and do not let leaves and other debris accumulate around the unit.

Leaves are a hotbed for small animals which can enter the unit. Once in the unit, such animals can cause malfunctions, smoke or fire when making contact with electrical parts.

Never touch the internal parts of the controller.

Do not remove the front panel. Touching certain internal parts will cause electric shocks and damage to the unit. Please consult your dealer about checking and adjustment of internal parts.

Do not leave the remote controller wherever there is a risk of wetting.

If water gets into the remote controller there is a risk of electrical leakage and damage to electronic components.

Turn off the power when the unit is not to be used for long periods of time.

Otherwise, the unit may get hot or catch on fire due to dust accumulation.

Watch your steps at the time of air filter cleaning or inspection.

High-place work is required, to which utmost attention must be paid.

If the scaffold is unstable, you may fall or topple down, thus causing injury.

2. OUTDOOR-AIR PROCESSING UNIT : NAME OF EACH PART (Refer to figure 1)

1. Air outlet
2. Remote controller
3. Air filter (Optional accessory)
4. Ground wire
5. Electric parts box
6. Outdoor air inlet
7. Refrigerant pipe and interconnecting wire
8. Power wire
9. Drain pipe
10. Heat exchanger
11. Fan
12. Drain pump kit (Optional accessory)

3. REMOTE CONTROLLER : NAME AND FUNCTION OF EACH SWITCH AND DISPLAY (Refer to figure 2)

1. On/off button

Press the button and the system will start. Press the button again and the system will stop.

2. Operation lamp (red)

The lamp lights up during operation.

3. Display “ ”

(changeover under control)

It is impossible to change heat/cool with the remote controller when this icon is displayed.

4. Display “” “” “” “” (operation mode)

This display shows the current operation mode.

5. Display “” (programmed time)

This display shows the programmed time of the system start or stop.

6. Display “ TEST” (inspection/test operation)

When the inspection/test operation button is pressed, the display shows the mode in which the system actually is.

7. Display “” (under centralized control)

When this display shows, the system is under centralized control.
(This is not a standard specification.)

8. Display “” (time to clean air filter)

When this display shows, it is the time to clean air filter.
(The air filter is an optional accessory.)

9. Display “/” (defrost/hot start)

Refer to the chapter “OPERATION PROCEDURE - EXPLANATION OF HEATING OPERATION.”

10. Timer mode start/stop button

Refer to the chapter “OPERATION PROCEDURE - PROGRAMMING START AND STOP OF THE SYSTEM WITH TIMER.”

11. Timer on/off button

Refer to the chapter “OPERATION PROCEDURE - PROGRAMMING START AND STOP OF THE SYSTEM WITH TIMER.”

12. Inspection/test operation button

This button is only used by qualified service persons for maintenance purposes.

13. Programming time button

Use this button for programming start and/or stop time.

14. Filter sign reset button

Refer to the chapter “MAINTENANCE”.

15. Operation mode selector button

Press this button to select the operation mode of your preference.

NOTE

- In contradistinction to actual operating situations, the display on figure 2 shows all possible indications.
- If the display “” (time to clean air filter) shows, clean the air filter as explained in the chapter “MAINTENANCE”. After cleaning and reinstalling the air filter, press the filter sign reset button on the remote controller. The filter sign lamp on the display will go out.
- This operation manual is for the Outdoor-Air Processing Unit.

See the outdoor unit’s operation manual for details on the indoor unit for room air conditioning.

4. OPERATION RANGE

Use the system in the following temperature and humidity ranges for safe and effective operation.

COOLING [°C]

OUTDOOR TEMPERATURE		
TEMPERATURE		HUMIDITY
D B	19 to 43 (Note)	30% to 90% (Long time operation in a humidity over 90% may cause condensation on the unit and dripping.)
W B	32 or below	

DB: Dry bulb temperature

WB: Wet bulb temperature

NOTE

- The FAN OPERATION mode is set automatically for DB temperature of 19°C and below.
- Do not use the COOLING OPERATION or FAN OPERATION modes when outdoor temperature is 5°C or lower. The unit will stop running to protect itself against cold damage. In such case, set the AUTOMATIC OPERATION or HEATING OPERATION mode.

HEATING [°C]

OUTDOOR TEMPERATURE	
D B	-5 to 15 (Note)

DB: Dry bulb temperature

NOTE

- The FAN OPERATION mode is set automatically for DB temperature of 15°C and above.

If the temperature or the humidity is beyond these conditions, safety devices may work and the unit may not operate.

5. OPERATION PROCEDURE

- To protect the unit, turn on the power supply 6 hours before operation.
- If the power supply is turned off during operation, operation will restart automatically after the power turns back on again.
- This unit cannot control room temperature. If room temperature control is needed, install it together with the indoor unit for room air conditioning.
- This unit is designed to operate so that the temperature of the outlet air is as close as possible to the set temperature. This may not be possible, however, due to the outdoor air temperature. When shipped from the factory, the set tempera-

ture is set at 18° C for cooling and 25° C for heating.

The set temperature can be changed between 13 and 25° C for cooling / 18 and 30° C for heating by local setting from remote controller. About set temperature or how to change it, ask your dealer.



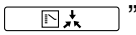
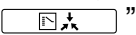

The set temperature will not be displayed on the remote controller.

5-1 COOLING, HEATING, AUTOMATIC, AND FAN ONLY OPERATION (Refer to figure 3)

- Changeover cannot be made with a remote controller whose display shows “” (changeover under control).
- When the display “” (changeover under control) flashes, refer to the chapter “5-3 SETTING THE MASTER REMOTE CONTROLLER”.
- The fan may keep on running for about 1 minute after the heating operation stops.
- The fan may stop immediately. This is not a malfunction.

Starting the system

- 1 Press the operation mode selector button several times and select the operation mode of your choice;

- “” Cooling operation
- “” Heating operation
- “” Automatic operation
- “” Fan only operation

NOTE

- Cooling / Heating operation
Outdoor air is cooled or warmed and brought indoors.
- Automatic operation
In this operation mode, cool/heat changeover is automatically conducted.
- Fan only operation
Outdoor air is brought indoors as is.

- 2 Press the on/off button.
The operation lamp lights up and the system starts operation.

Stopping the system

- 3 Press the on/off button once again.
The operation lamp goes off and the system stops operation.

NOTE

- Do not turn off the power supply immediately after the unit stops, but wait for at least 5 minutes.

EXPLANATION OF HEATING OPERATION



Defrost operation

- In heating operation, freezing of the outdoor unit coil increases. Heating capability decreases and the system goes into defrost operation.
- The indoor unit fan stops and the remote controller displays “”.
- After maximum 12 minutes of defrost operation, the system returns to heating operation again.



Hot start

- In order to prevent cold air from blowing out of an indoor unit at the start of heating operation, the indoor fan is automatically stopped. The display of the remote controller shows “”.

5-2 PROGRAMMING START AND STOP OF THE SYSTEM WITH TIMER (Refer to figure 4)

- The timer is operated in the following two ways.
Programming the stop time “” : The system stops operating after the set time has elapsed.
Programming the start time “” : The system starts operating after the set time has elapsed.
- The timer can be programmed for a maximum of 72 hours.
- The start and the stop time can be simultaneously programmed.



- 1 Press the timer mode start/stop button several times and select the mode on the display. The display flashes.

- For setting the timer stop “”
- For setting the timer start “”



- 2 Press the programming time button and set the time for stopping or starting the system.

- Each time this button is pressed, the time advances or goes backward by 1 hour.



- 3 Press the timer on/off button.
The timer setting procedure ends. The display “” or “” changes from flashing light to constant light.

NOTE

- When setting the timer stop and start at the same time, repeat the above procedure (from “” to “”) once again.
- After the timer is programmed, the display shows the remaining time.
- Press the timer on/off button once again to cancel programming. The display vanishes.

For example: (Refer to figure 5)

When the timer is programmed to stop the system after 3 hours and start the system after 4 hours, the system will stop after 3 hours and start 1 hour later.

5-3 SETTING THE MASTER REMOTE CONTROLLER (Refer to figure 6)

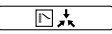
- When the system is installed as shown in figure 7 and 8, it is necessary to designate one of the remote controllers as the master remote controller.
 - When one outdoor unit is connected with several outdoor-air processing units, designate one of the remote controllers as the master remote controller. (Refer to figure 7)
 - When one outdoor unit is connected with outdoor-air processing units and indoor units for room air conditioning, designate one of the remote controllers of the indoor units as the master remote controller. (Refer to figure 8)
- Otherwise, operation of system will be changed by outdoor air condition during automatic operation.
- Only the master remote controller can select heating, cooling or automatic (Only if the remote controller of outdoor air processing unit is designated as the master remote controller.) operation.
 - The displays of slave remote controllers show “” (changeover under control) and they automatically follow the operation mode directed by the master remote controller.
 - However, it is possible to change to fan only operation with slave remote controllers.

How to designate the master remote controller (Refer to figure 6)

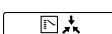
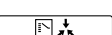
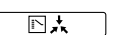
- 1 Press the operation mode selector button of the current master remote controller for 4 seconds. The display showing “” (changeover under control) of all slave remote controllers connected to the same outdoor unit flashes.
- 2 Press the operation mode selector button of the controller that you wish to designate as the master remote controller. Then designation is completed. This remote controller is designated as the master remote controller and the display showing “” (changeover under control) vanishes. The displays of other remote controllers show “” (changeover under control).

5-4 PRECAUTIONS FOR GROUP CONTROL SYSTEM OR TWO REMOTE CONTROLLERS CONTROL SYSTEM

This system provides two other control systems beside individual control (one remote controller controls one indoor unit) system. Confirm the following if your unit is of the following control system type.

• Group control system

One remote controller controls up to 16 indoor units. All indoor units are equally set.

• Two remote controllers control system

Two remote controllers control one indoor unit (in case of group control system, one group of indoor units). The unit is individually operated.

NOTE

- Contact your Daikin dealer in case of changing the combination or setting of group control and two remote controllers control systems.

6. OPTIMUM OPERATION

Observe the following precautions to ensure the system operates properly.

- Adjust the air outlet properly and avoid direct air flow to room inhabitants.
- Adjust the room temperature properly for a comfortable environment. Avoid excessive heating or cooling.
- Prevent direct sunlight from entering a room during cooling operation by using curtains or blinds.
- Ventilate often. Extended use requires special attention to ventilation.
- Keep doors and windows closed. If the doors and windows remain open, air will flow out of your room causing a decrease in the cooling or heating effect.
- Never place objects near the air inlet or the air outlet of the unit. It may cause deterioration in the effect or stop the operation.
- Turn off the power supply to the unit when the unit is not used for longer periods of time. If the switch is on, it uses electricity. Before restarting the unit, turn on the power supply 6 hours before operation to ensure smooth running. (Refer to the chapter “OPERATION PROCEDURE”.)
- When the display shows “” (time to clean the air filter), ask a qualified service person to clean the filters. (Refer to the chapter “MAINTENANCE”.)
- Keep the indoor unit and remote controller at least 1 m away from televisions, radios, stereos, and other similar equipment. Failing to do so may cause static or distorted pictures.
- It takes time for the room temperature to reach the set temperature. We recommend starting the operation in advance using timer operation.

7. MAINTENANCE

⚠ WARNING

- ONLY A QUALIFIED SERVICE PERSON IS ALLOWED TO PERFORM MAINTENANCE.
- BEFORE OBTAINING ACCESS TO TERMINAL DEVICES, ALL POWER SUPPLY CIRCUITS MUST BE INTERRUPTED.
- DO NOT USE WATER OR AIR OF 50° C OR HIGHER FOR CLEANING AIR FILTERS.

7-1 HOW TO CLEAN THE AIR FILTER

(The air filter is an optional accessory.)

About DAIKIN long life replacement filter

Clean the air filter when the display shows “” (time to clean air filter).

Increase the frequency of cleaning if the unit is installed in a room where the air is extremely contaminated.

(As a yardstick for regulating yourself, consider cleaning the filter.)

1. Remove the air filters.

2. Clean the air filter.

Use vacuum cleaner **A)** or wash the air filter with water **B)**.

A) Using a vacuum cleaner.



B) Washing with water.

To clean the air filter, use soft brush and neutral detergent.

Remove water and dry in the shade after cleaning.



3. Fix the air filter.

4. Press the FILTER SIGN RESET BUTTON on the remote controller.

The display “” (time to clean air filter) vanishes.

About other air filter.

Clean the air filter by suitable method in the filter.

NOTE

- Do not remove the air filter except when cleaning. Unnecessary handling may damage the filter.

HOW TO CLEAN AIR OUTLET

1. Clean with soft cloth.

2. When it is difficult to remove stains, use water or neutral detergent.

NOTE

- Do not use gasoline, benzene, thinner, polishing powder, liquid insecticide. It may cause discolouring or warping.
- Do not let the unit get wet. It may cause an electric shock or a fire.

8. FOLLOWING SYMPTOMS ARE NOT SYSTEM TROUBLES

8-1 THE SYSTEM DOES NOT OPERATE

- The system does not start immediately after the ON/OFF button on the remote controller is pushed.

If the operation lamp lights, the system is in normal condition.

To prevent overloading of the compressor motor, the system starts 5 minutes after it is turned ON again in case it was turned OFF just before. The same starting delay occurs after the operation mode selector button was used.

- If the display shows “” (under centralized control) and pressing the operation button causes the display to blink for a few seconds.

This indicates that the central device is controlling the unit.

The blinking display indicates that the remote controller cannot be used.

- The system does not start immediately after the power supply is turned on.

Wait one minute until the micro computer is prepared for operation.

8-2 COOL/HEAT CANNOT BE CHANGED OVER

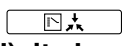
- When the display shows “” (changeover under control), it shows that this is a slave remote controller.

- When the cool/heat changeover remote control switch is installed and the display shows “” (changeover under control).

This is because cool/heat changeover is controlled by the cool/heat changeover remote control switch. Ask your Daikin dealer where the remote control switch is installed.

8-3 FAN OPERATION IS POSSIBLE, BUT COOLING AND HEATING DO NOT WORK

- When the outdoor temperature exceeds the range of use conditions, the unit automatically changes into fan mode from cooling or heating modes.

8-4 NO AIR COMES OUT

- **The outdoor temperature has dropped to 0°C or lower while in “cooling” or “fan” modes.**
The fan automatically stops due to the outdoor air temperature.

8-5 WHITE MIST COMES OUT OF A UNIT

Outdoor-air processing unit

- **When humidity is high during cooling operation.**

If the interior of the unit is extremely contaminated, the temperature distribution inside the unit becomes uneven. It is necessary to clean the interior of the unit. Ask your Daikin dealer for details on cleaning the unit. This operation requires a qualified service person.

- **Immediately after the cooling operation stops and if the outdoor temperature and humidity are low.**

This is because warm refrigerant gas flows back into the unit and generates steam.

Outdoor-air processing unit, outdoor unit

- **When the system is changed over to heating operation after defrost operation.**

Moisture generated by defrost becomes steam and is exhausted.

8-6 NOISE OF SYSTEM

Outdoor-air processing unit

- **A “zeen” sound is heard immediately after the power supply is turned on.**

The electronic expansion valve inside the unit starts working and makes the noise. Its volume will reduce in about one minute.

- **A continuous low “shah” sound is heard when the system is in cooling operation or at a stop.**

When the drain pump (optional accessories) is in operation, this noise is heard.

- **A “pishi-pishi” squeaking sound is heard when the system stops after heating operation.**

Expansion and contraction of plastic parts caused by temperature change make this noise.

- **A low “sah”, “choro-choro” sound is heard while the unit is stopped.**

When the other unit is in operation, this noise is heard. In order to prevent oil and refrigerant from remaining in the system, a small amount of refrigerant is kept flowing.

Outdoor-air processing unit, outdoor unit

- **A continuous low hissing sound is heard when the system is in cooling or defrost operation.**

This is the sound of refrigerant gas flowing through the system.

- **A hissing sound which is heard at the start or immediately after stopping operation or defrost operation.**

This is the noise of refrigerant caused by flow stop or flow change.

Outdoor unit

- **When the tone of operating noise changes.**

This noise is caused by the change of frequency.

8-7 DUST COMES OUT OF THE UNIT

- **When the unit is used after having stopped operating for a long time.**

This is because dust has gotten into the unit.

8-8 THE UNITS MAY GIVE OFF ODOURS

- **The unit may absorb the smell of outdoor air.**

8-9 THE OUTDOOR UNIT FAN DOES NOT SPIN

- **During operation.**

The speed of the fan is controlled in order to optimize product operation.

8-10 THE DISPLAY SHOWS “88”

- **This is the case immediately after the power supply is turned on and means that the remote controller is in normal condition. This continues for one minute.**

8-11 THE COMPRESSOR IN THE OUTDOOR UNIT DOES NOT STOP AFTER A SHORT HEATING OPERATION

- **This is to prevent oil and refrigerant from remaining in the compressor. The unit will stop after 5 to 10 minutes.**

8-12 THE INSIDE OF AN OUTDOOR UNIT IS WARM EVEN WHEN THE UNIT HAS STOPPED

- **This is because the crankcase heater is warming the compressor so that the compressor can start smoothly.**

9. TROUBLE SHOOTING

If one of the following malfunctions occur, take the measures shown below and contact your Daikin dealer.

The system must be repaired by a qualified service person.

- If a safety device such as a fuse, a breaker or an earth leakage breaker frequently actuates, or the ON/OFF switch does not properly work;
Measure: Turn off the power supply.
- If water leaks from unit;
Measure: Stop the operation.
- If the display “ TEST”, the unit number and the operation lamp flash and the malfunction code appears; **(Refer to figure 9)**
 1. Inspection display
 2. Unit number in which a malfunction occurs
 3. Operation lamp
 4. Malfunction codeMeasure: Notify your Daikin dealer and report the malfunction code.

If the system does not properly operate except for the above mentioned cases and none of the above mentioned malfunctions is evident, investigate the system according to the following procedures.

1. If the system does not operate at all;
 - Check if there is no power failure.
Wait until power is restored. If power failure occurs during operation, the system automatically restarts immediately after the power supply is recovered.
 - Check if no fuse has blown or breaker has worked.
Change the fuse or reset the breaker if necessary.
2. If the system goes into fan only operation, but as soon as it goes into heating or cooling operation, the system stops;
 - Check if air inlet or outlet of outdoor unit or outdoor-air processing unit is not blocked by obstacles.
Remove any obstacle and make it well-ventilated.
 - Check if the remote controller display shows “” (time to clean the air filter). (Refer to the chapter “MAINTENANCE”.)
3. The system operates but cooling or heating is insufficient;
 - Check if air inlet or outlet of outdoor or outdoor-air processing unit is not blocked by obstacles.
Remove any obstacle and make it well-ventilated.
 - Check if the air filter is not clogged. (Refer to the chapter “MAINTENANCE”.)

DAIKIN INDUSTRIES, LTD.

Head office:
Umeda Center Bldg., 2-4-12, Nakazaki-Nishi,
Kita-ku, Osaka, 530-8323 Japan

Tokyo office:
JR Shinagawa East Bldg., 2-18-1, Konan,
Minato-ku, Tokyo, 108-0075 Japan

DAIKIN EUROPE NV

Zandvoordestraat 300, B-8400 Oostende, Belgium